



Interocean EMC Technology Corp. Filing No.: 7A012601E-04

## Verification of Conformity

Applicant : **MEAN WELL ENTERPRISES CO., LTD.**  
No.28, Wuquan 3rd Rd., Wugu Dist., New Taipei City 248,  
Taiwan (R.O.C.)

Product : **Switching Power Supply**  
Model No. : NSD10-xyz  
(x=12 or 48, y=S or D, z=3, 5, 9, 12, 15)

**On the basis of the tests undertaken, the sample(s) of the above product have been found to comply with the essential requirements of the referenced specifications at the time the tests were carried out.**

The holder of the verification is authorized to use this document in connecting with the EC declaration of conformity is according to the Directives.

The CE marking may only be used if all relevant and effective EC Directives are complied with. Together with the manufacturer's own documented production control, the manufacturer (or his European authorized representative) can in his EC Declaration of Conformity verify compliance with the Directives.

### **Harmonized Standards**

EN 55022: 2010 (Class B)  
EN 55032: 2015+AC: 2016 (Class B)  
EN 55024: 2010+A1: 2015

Note: The equipment covered by this document is subject to mandatory compliance with – the European Council Directive (2014/30/EU)

**Issued By:**

Mike Huang / President

**Date: Feb. 10, 2017**

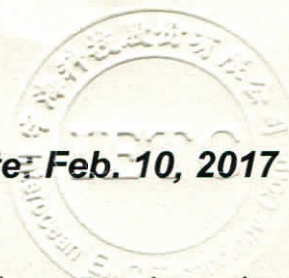

# Test Report



(Declaration of Conformity)

for

Electromagnetic Compatibility

of

Product : **Switching Power Supply**

Trade Name : MEAN WELL

Model Number : NSD10-xyz  
(x=12 or 48, y=S or D, z=3, 5, 9, 12, 15)

Prepared for

**MEAN WELL ENTERPRISES CO., LTD.**

No.28, Wuquan 3rd Rd., Wugu Dist., New Taipei City 248,  
Taiwan (R.O.C.)

TEL.: +886 2 2299 6100

FAX.: +886 2 2299 6200

Prepared by

**Interocean EMC Technology Corp.**

**Interocean EMC Technology Tin-Fu Laboratory**

No. 5-2, Lin 1, Tin-Fu, Lin-Kou Dist., New Taipei City,  
Taiwan 244, R.O.C.

TEL.: +886 2 2600 6861

FAX.: +886 2 2600 6859

**Remark:**

The test report consists of **16** pages in total. It shall not be reproduced except in full, without the written approval of IETC. This document may be altered or revised by IETC only, and shall be noted in the revision section of the document.

The test result in this report is only subjected to the test sample.

# Table of Contents

<b>1</b>	<b>General Information</b>	<b>4</b>
1.1	Description of Equipment Under Test	4
1.2	Specifications	6
1.3	Details of Tested Supporting System	7
1.4	Test Facility	8
1.5	Measurement Uncertainty	9
1.6	Configuration of EUT Setup	10
<b>2</b>	<b>Radiated Emission Measurement (Below 1 GHz)</b>	<b>11</b>
2.1	Instrument	11
2.2	Block Diagram of Test Configuration	11
2.3	Radiated Limit	12
2.4	Instrument Configuration	12
2.5	Configuration of Measurement	12
2.6	Test Result	12
<b>3</b>	<b>Surge Immunity Test (EN 61000-4-5)</b>	<b>15</b>
3.1	Test Levels	15
<b>4</b>	<b>Photographs of Test</b>	<b>16</b>
4.1	Radiated Emission Measurement	16

# Statement of Compliance

**Applicant:** MEAN WELL ENTERPRISES CO., LTD.

**Manufacturer:** 1. MEAN WELL Enterprises Co., Ltd.  
2. MEAN WELL (GUANGZHOU) Electronics Co., Ltd HUADU BRANCH  
3. SuZhou MEAN WELL Technology Co., Ltd.

**Product:** Switching Power Supply

**Model No.:** NSD10-xyz  
(x=12 or 48, y=S or D, z=3, 5, 9, 12, 15)

**Tested Power Voltage:** DC 12V; DC 48V

**Date of Final Test:** Jan. 12, 2017

**Revision of Report:** Rev. 01

### Measurement Procedures and Standards Used :

Emission:

- EN 55022: 2010
- EN 55032: 2015+AC: 2016

Immunity:

- EN 55024: 2010+A1: 2015
- EN 61000-4-2: 2009
- EN 61000-4-3: 2006+A1: 2008+A2: 2010
- EN 61000-4-4: 2012
- EN 61000-4-5: 2014
- EN 61000-4-6: 2014
- EN 61000-4-8: 2010
- EN 61000-4-11: 2004

The measurement results in this test report were performed at Interocean EMC Technology Corp. the responsibility of measurement result is only subjected to the tested sample. This report shows the EUT is technically compliance with the above official standards. This report shall not be partial reproduced without written approval by Interocean EMC Technology Corporation.

Report Issued: 2017/02/10

Project Engineer: Ceres Cheng  
Ceres Cheng

Approved: Roy Chiang  
Roy Chiang

# 1 General Information

## 1.1 Description of Equipment Under Test

- Product** : Switching Power Supply
- Model Number** : NSD10-xyz  
(x=12 or 48, y=S or D, z=3, 5, 9, 12, 15)
- Applicant** : **MEAN WELL ENTERPRISES CO., LTD.**  
No.28, Wuquan 3rd Rd., Wugu Dist., New Taipei City 248,  
Taiwan (R.O.C.)
- Manufacturer** : **1. MEAN WELL Enterprises Co., Ltd.**  
No.28, Wuquan 3rd Rd., Wugu Dist., New Taipei City 248,  
Taiwan (R.O.C.)  
**2. MEAN WELL (GUANGZHOU) Electronics Co., Ltd HUADU BRANCH**  
No.11 Jingu South Road, Huadong Town, Huadu District, Guangzhou,  
China.  
**3. SuZhou MEAN WELL Technology Co., Ltd.**  
No. 77, Jian-min Road, Dong-qiao, Pan-yang Ind. Park, Huang-dai Town,  
Xiang-cheng District, Suzhou, Jiangsu 215152, P.R. China
- Product Information** : Input: 12Vdc / 1.4A; 48Vdc / 0.4A  
Output: The detailed specification, please see "Specifications" as below.
- Date of Test** : Jan. 12, 2017 (For 7A012601E-04)
- Additional Description** : **(For 7A012601E)**
- 1.) The Model Number "**NSD10-12D5; NSD10-12D12; NSD10-12D15; NSD10-48D5; NSD10-48D12; NSD10-48D15; NSD10-12S3; NSD10-12S5; NSD10-12S9; NSD10-12S12; NSD10-12S15; NSD10-48S3; NSD10-48S5; NSD10-48S9; NSD10-48S12; NSD10-48S15**" are representative selected in the test and included in this report.
  - 2.) All models are identical except for model name and O/P rating.
- (For 7A012601E-01)**
- 1.) 7A012601E-01 is a multiple report of 7A012601E, the difference is upgraded the measurement of IEC 61000-4-4 and IEC 61000-4-5, the rest parts are identical.
  - 2.) The test model is "**NSD10-12S5**" and included in this report.
- (For 7A012601E-02)**
- 1.) 7A012601E-02 is a multiple report of 7A012601E-01, the differences are updated the standard, added two manufacturers and changed the address of Applicant and Manufacturer (because of municipality change by government), therefore re-measured EN 61000-4-3 test, the rest parts are identical.
  - 2.) The Model Number "**NSD10-12D5; NSD10-12S5**" are representative selected in the test and included in this report.

**Additional Description : (For 7A012601E-03)**

- 1.) 7A012601E-03 is a multiple report of 7A012601E-02, the difference is updated the standard, therefore re-measured EN 61000-4-4 test, the rest parts are identical.
- 2.) The Model Number “**NSD10-12D5; NSD10-12S5**” are representative selected in the test and included in this report.

**(For 7A012601E-04)**

- 1.) 7A012601E-04 is a multiple report of 7A012601E-03, the differences are updated the standard, added the standard of EN 55032, removed standards of EN 55011, EN 61000-6-1, EN 61000-6-3 & EN 61204-3 and changed the information of GUANGZHOU Manufacturer, therefore re-measured radiation test (For the standard of EN 55032), the rest parts are identical.
- 2.) The test model is “**NSD10-12S5**” and included in this report.
- 3.) Correct the test levels table about EN 61000-4-5 (Original information was shown in section 4.3.1 for report of 7A012601E-01).

## 1.2 Specifications

Model No.		Output	
		Voltage (Vdc)	Current (A)
NSD10-12D5	NSD10-48D5	5	1
		-5	1
NSD10-12D12	NSD10-48D12	12	0.42
		-12	0.42
NSD10-12D15	NSD10-48D15	15	0.33
		-15	0.33
NSD10-12S3	NSD10-48S3	3.3	2.5
NSD10-12S5	NSD10-48S5	5	2
NSD10-12S9	NSD10-48S9	9	1.1
NSD10-12S12	NSD10-48S12	12	0.83
NSD10-12S15	NSD10-48S15	15	0.67

### 1.3 Details of Tested Supporting System

1.3.1 Load (NSD10-12S5)

Full Load Watt : 10W (5 Vdc, 2 A)



## 1.4 Test Facility

- Site Description** : ☒OATS 1
- Name of Firm** : Interocean EMC Technology Corp.
- Company web** : <http://www.ietc.com.tw>
- Location** : No. 5-2, Lin 1, Tin-Fu, Lin-Kou Dist., New Taipei City, Taiwan 244, R.O.C.
- Site Filing** :
- Federal Communication Commissions – USA  
Designation No.: TW1020 (Test Firm Registration #: 651092)  
Designation No.: TW1113 (Test Firm Registration #: 959554)
  - Industry Canada (IC)  
OUR FILE: 46405-4437  
Registration No. (OATS 1): Site# 4437A-1  
Registration No. (OATS 3): Site# 4437A-3  
Registration No. (Chamber 3): Site# 4437A-5  
Registration No. (OATS 5): Site# 4437A-6
  - Voluntary Control Council for Interference by Information Technology Equipment (VCCI) – Japan  
Member No.: 1349  
Registration No. (Conducted Room): C-1094  
Registration No. (Conducted Room): T-1562  
Registration No. (OATS 1): R-1040; G-10274
- Site Accreditation** :
- Bureau of Standards and Metrology and Inspection (BSMI) – Taiwan, R.O.C.  
Accreditation No.:  
SL2-IN-E-0026 for CNS 13438 / CISPR 22  
SL2-R1-E-0026 for CNS 13439 / CISPR 13  
SL2-R2-E-0026 for CNS 13439 / CISPR 13  
SL2-L1-E-0026 for CNS 14115 / CISPR 15
  - Taiwan Accreditation Foundation (TAF)  
Accreditation No.: 1113
  - Vehicle Safety Certification Center (VSCC)  
Approval No.: TW16-11
  - TÜV NORD  
Certificate No: TNTW0801R

**1.5 Measurement Uncertainty**

<b>Item</b>	<b>Value</b>
<b>Conduction 1:</b>	
Conducted Emission - AMN (9 kHz to 30 MHz)	2.98 dB
Conducted Emission - AAN (ISN-T4) (150 kHz to 30 MHz)	3.70 dB
Conducted Emission - AAN (ISN-T8) (150 kHz to 30 MHz)	3.70 dB
Conducted Emission - CP (9 kHz to 30 MHz)	3.06 dB
Conducted Emission - VP (9 kHz to 30 MHz)	2.42 dB
Radiated Emission - LAS (2 m Loop) (9 kHz to 30 MHz)	3.26 dB
<b>Conduction 2:</b>	
Disturbance Power (30 MHz to 300 MHz)	4.04 dB
<b>OATS 1:</b>	
Radiated Emission Test (30 MHz to 1 GHz)	4.84 dB
Radiated Emission Test (1 GHz to 6 GHz)	4.84 dB
<b>OATS 3:</b>	
Radiated Emission Test (30 MHz to 1 GHz)	4.70 dB
<b>OATS 5:</b>	
Radiated Emission Test (30 MHz to 1 GHz)	4.70 dB
<b>Chamber 3:</b>	
Radiated Emission Test (9 kHz to 30 MHz)	3.12 dB
Radiated Emission Test (30 MHz to 1 GHz)	4.86 dB
Radiated Emission Test (1 GHz to 6 GHz)	4.78 dB
Induced Current Density (20 kHz to 10 MHz)	1.82 dB
<b>Conducted Immunity Room:</b>	
Conducted Immunity Test / CDN-M2	1.30 dB
Conducted Immunity Test / CDN-M3	1.30 dB
Conducted Immunity Test / EM Clamp	3.16 dB

### 1.6 Configuration of EUT Setup

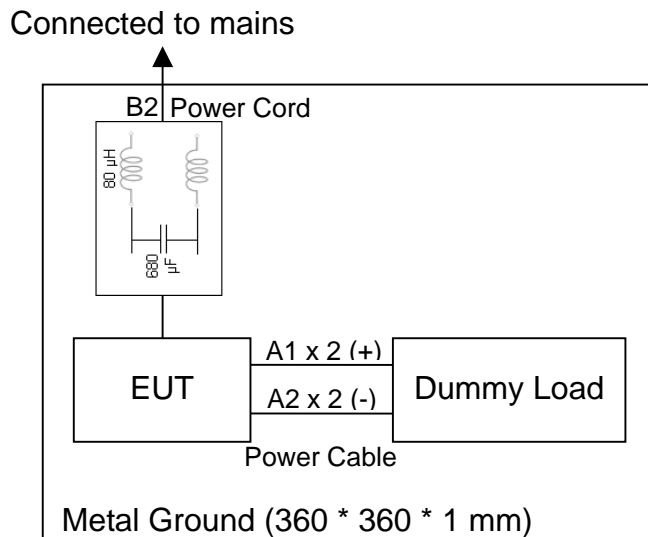

Remark: 1. The length of power cable is 0.1 m long.

No.	Cable	Length	Shielded	Shielded Backshell	Supported by lab.	Note
A1	Power Cable (+)	0.1 m				
A2	Power Cable (-)	0.1 m				
B1	Power Cord (Inlet)	N/A				
B2	Power Cord (Input Cable) (For EN 55022)	0.15 m			✓	
B2	Power Cord (Input Cable) (For EN 55032)	1 m			✓	

## 2 Radiated Emission Measurement (Below 1 GHz)

### 2.1 Instrument

Instrument	Manufacturer	Model	Serial No.	Next Cal. Date
EMI Test Receiver	Rohde & Schwarz	ESVS10	826148/011	2017/10/19
Biconical Antenna	Schwarzbeck	VHA 9103 & BBA 9106	VHA 9103-2418	2017/07/13
Log Antenna	Schwarzbeck	UHALP 9108-A	9108-A 0739	2017/07/13
Pre-Amplifier	Agilent	8447D	2944A09703	2017/08/02
RF Cable	EMCI	EMC8D-NM-NM-25000	140105	2017/08/02
RF Cable	Mini-Circuits	CBL-3FL-NMNM	CBL56	2017/08/02
Measurement Software	AUDIX-e3			

Note: The above equipments are within the valid calibration period.

### 2.2 Block Diagram of Test Configuration

For EN 55032

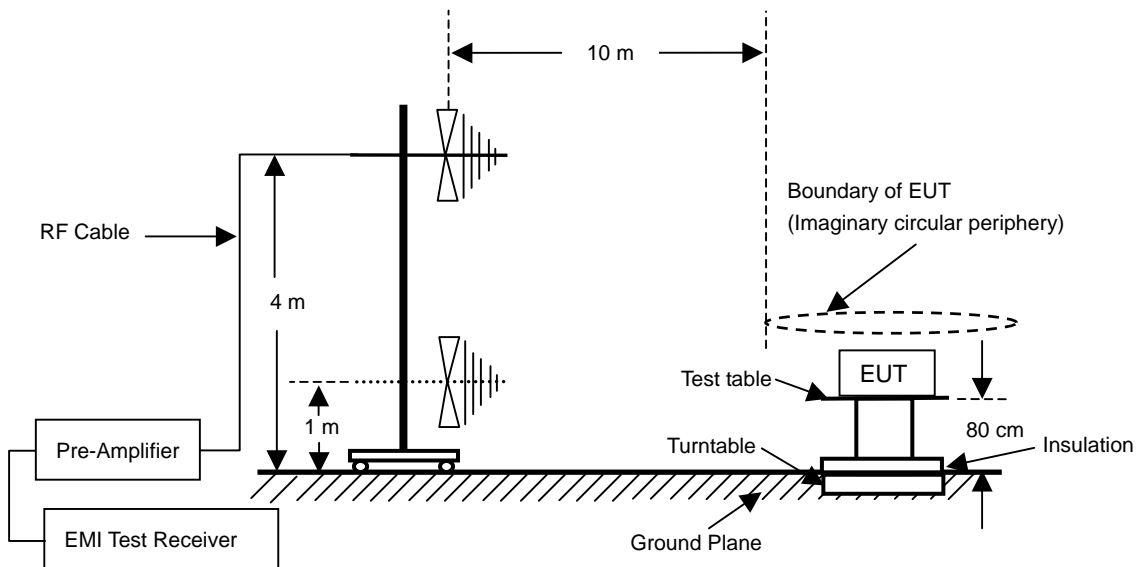

### 2.3 Radiated Limit

Frequency (MHz)	<input type="checkbox"/> Class A	<input checked="" type="checkbox"/> Class B
	Quasi-Peak dB( $\mu$ V/m)	Quasi-Peak dB( $\mu$ V/m)
30 to 230	40.0	30.0
230 to 1000	47.0	37.0

### 2.4 Instrument Configuration

- 2.4.1 Set the EMI test receiver frequency range from 30 MHz to 1000 MHz.
- 2.4.2 Set the EMI test receiver bandwidth at 120 kHz.
- 2.4.3 Set the EMI test receiver detector as Quasi-Peak (Q.P.).

### 2.5 Configuration of Measurement

- 2.5.1 The EUT was placed on a non-conductive table whose total height equaled 80 cm. The turntable can rotate 360 degree to determine the position of the maximum emission level.
- 2.5.2 The EUT was set 10 meters away from the receiving antenna that was mounted on a non-conductive mast. The antenna can move up and down between 1 to 4 meters to find out the maximum emission level.
- 2.5.3 The initial testing identified the frequency that has the highest disturbance relative to the limit while operating the EUT in typical modes of operation and cable positions in a test setup representative of typical system configuration.
- 2.5.4 The identification of the frequency of highest emission with respect to the limit was found by investigating emissions at a number of significant frequencies. The probable frequency of maximum emission had been found and that the associated cable and EUT configuration and mode of operation had been identified.

### 2.6 Test Result

**PASS.**

The final test data is shown as following pages.

Factor = Antenna Factor + Cable Loss - Preamplifier Gain

Level = Reading + Factor

Margin = Level - Limit

## Radiated Emission Measurement Data

CLIENT: MEAN WELL ENTERPRISES CO., LTD.  
 EUT: Switching Power Supply  
 MODEL: NSD10-12S5  
 RATING: DC 12V  
 COMMENT: Test Mode: Full Load (NSD10-12S5) (DC 12V) (For EN 55032)

OPERATOR : Evans  
 TEST SITE : OATS 1  
 TEST DISTANCE : 10 m  
 POLARIZATION : HORIZONTAL  
 TEMP/HUM : 23.9°C / 342%

Data:736

2017-01-12

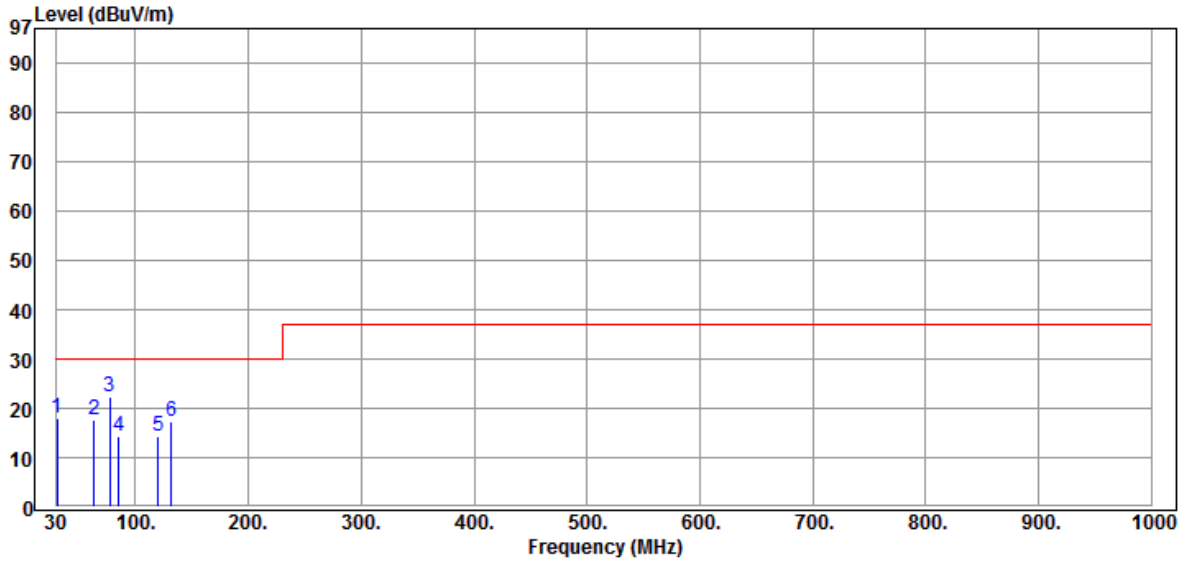

Item Mark	Freq. MHz	Reading dBuV	Factor dB/m	Level dBuV/m	Limit dBuV/m	Margin dB	Remark
1	30.340	30.00	-11.97	18.03	30.00	-11.97	QP
2	63.400	40.00	-22.32	17.68	30.00	-12.32	QP
3	77.000	45.70	-23.46	22.24	30.00	-7.76	QP
4	85.490	37.01	-22.83	14.18	30.00	-15.82	QP
5	120.000	31.00	-16.51	14.49	30.00	-15.51	QP
6	131.800	33.01	-15.71	17.30	30.00	-12.70	QP

## Radiated Emission Measurement Data

CLIENT: MEAN WELL ENTERPRISES CO., LTD.  
 EUT: Switching Power Supply  
 MODEL: NSD10-12S5  
 RATING: DC 12V  
 COMMENT: Test Mode: Full Load (NSD10-12S5) (DC 12V) (For EN 55032)

OPERATOR : Evans  
 TEST SITE : OATS 1  
 TEST DISTANCE : 10 m  
 POLARIZATION : VERTICAL  
 TEMP/HUM : 23.9°C / 342%

Data:735

2017-01-12

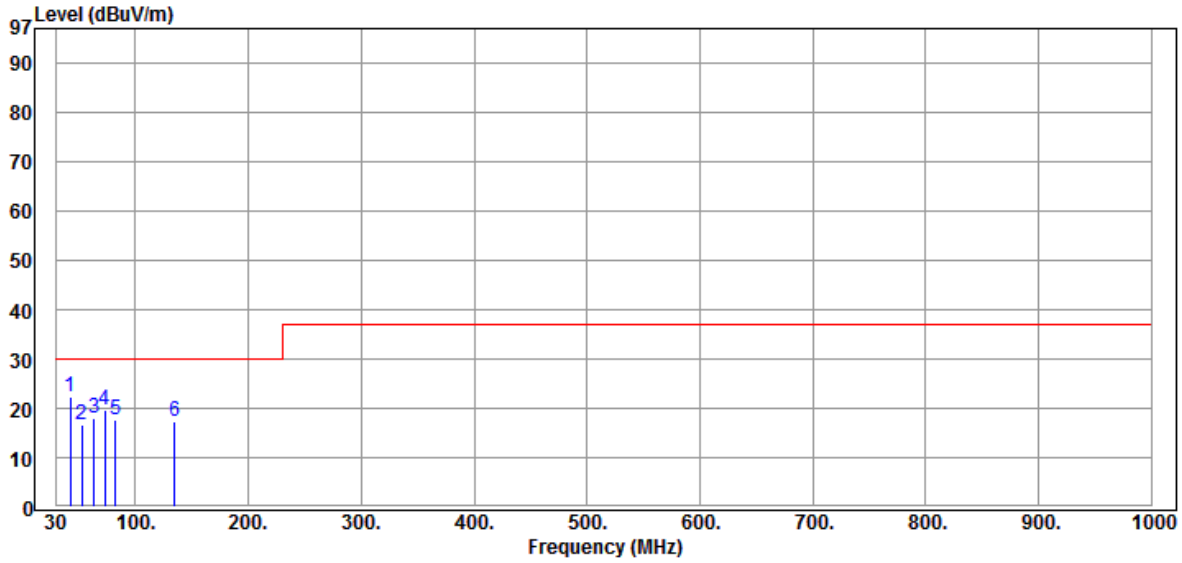

Item Mark	Freq. MHz	Reading dBuV	Factor dB/m	Level dBuV/m	Limit dBuV/m	Margin dB	Remark
1	42.080	39.01	-16.53	22.48	30.00	-7.52	QP
2	52.450	36.41	-19.83	16.58	30.00	-13.42	QP
3	63.460	40.40	-22.33	18.07	30.00	-11.93	QP
4	72.580	43.00	-23.30	19.70	30.00	-10.30	QP
5	81.980	40.99	-23.29	17.70	30.00	-12.30	QP
6	134.900	32.99	-15.54	17.45	30.00	-12.55	QP

### 3 Surge Immunity Test (EN 61000-4-5)

#### 3.1 Test Levels

Level	Open-circuit test voltage (kV)	
	Line-to-line	Line-to-ground <sup>b</sup>
1	---	0.5
2	0.5	1
3	1	2
4	2	4
X <sup>a</sup>	Special	Special

<sup>a</sup> "X" can be any level, above, below or in between the others. The level shall be specified in the dedicated equipment specification.

<sup>b</sup> For symmetrical interconnection lines the test can be applied to multiple lines simultaneously with respect to ground, i.e. "lines to ground".



## 4 Photographs of Test

### 4.1 Radiated Emission Measurement



Front View (For EN 55032 Standard)



Rear View (For EN 55032 Standard)

# Test Report



(Declaration of Conformity)

for

Electromagnetic Compatibility

of

Product : **Switching Power Supply**

Trade Name : MEAN WELL

Model Number : NSD10-xyz  
(x=12 or 48, y=S or D, z=3, 5, 9, 12, 15)

Prepared for

**MEAN WELL ENTERPRISES CO., LTD.**

No.28, Wuquan 3rd Rd., Wugu Dist., New Taipei City 248,  
Taiwan (R.O.C.)

TEL.: +886 2 2299 6100

FAX.: +886 2 2299 6200

Prepared by

**Interocean EMC Technology Corp.**

No. 5-2, Lin 1, Tin-Fu, Lin-Kou Dist., New Taipei City,  
Taiwan 244, R.O.C.

TEL.: +886 2 2600 6861

FAX.: +886 2 2600 6859

**Remark:**

The test report consists of **15** pages in total. It shall not be reproduced except in full, without the written approval of IETC. This document may be altered or revised by IETC only, and shall be noted in the revision section of the document.

The test result in this report is only subjected to the test sample.

# Table of Contents

<b>1</b>	<b>General Information</b>	<b>4</b>
1.1	Description of Equipment Under Test	4
1.2	Specifications	6
1.3	Details of Tested Supporting System	7
1.4	Test Facility	8
1.5	Configuration of EUT Setup	9
<b>2</b>	<b>Performance Criterion of Immunity Test</b>	<b>10</b>
2.1	EN 55024	10
2.2	EN 61204-3	11
2.3	EN 61000-6-1	11
<b>3</b>	<b>Electrical Fast Transient/Burst Immunity Test (EN 61000-4-4)</b>	<b>12</b>
3.1	Instrument	12
3.2	Block Diagram of Test Configuration	12
3.3	Test Levels	12
3.4	Test Requirement	13
3.5	Configuration of Measurement	13
3.6	Test Result	14

# Statement of Compliance

**Applicant:** MEAN WELL ENTERPRISES CO., LTD.

**Manufacturer:** 1. Mean Well Enterprises Co., Ltd.  
2. Mean Well (GUANGZHOU) Electronics Co., Ltd.  
3. SuZhou Mean Well Technology Co., Ltd.

**Product:** Switching Power Supply

**Model No.:** NSD10-xyz  
(x=12 or 48, y=S or D, z=3, 5, 9, 12, 15)

**Tested Power Supply:** DC 12V; DC 48V

**Date of Final Test:** Aug. 06, 2015

**Revision of Report:** Rev. 02

### Measurement Procedures and Standards Used :

Emission:

- EN 55011: 2009+A1: 2010
- EN 55022: 2010
- EN 61000-6-3: 2007+A1: 2011

Immunity:

- EN 55024: 2010
- EN 61204-3: 2000
- EN 61000-6-1: 2007
- EN 61000-4-2: 2009
- EN 61000-4-3: 2006+A1: 2008+A2: 2010
- EN 61000-4-4: 2012
- EN 61000-4-5: 2006
- EN 61000-4-6: 2014
- EN 61000-4-8: 2010
- EN 61000-4-11: 2004

The measurement results in this test report were performed at Interocean EMC Technology Corp. the responsibility of measurement result is only subjected to the tested sample. This report shows the EUT is technically compliance with the above official standards. This report shall not be partial reproduced without written approval by Interocean EMC Technology Corporation.

Report Issued: 2015/09/10

Project Engineer: Evans Chang Approved: Gimmy Tsai  
 Evans Chang Gimmy Tsai

## 1 General Information

### 1.1 Description of Equipment Under Test

- Product** : Switching Power Supply
- Model Number** : NSD10-xyz  
(x=12 or 48, y=S or D, z=3, 5, 9, 12, 15)
- Applicant** : **MEAN WELL ENTERPRISES CO., LTD.**  
No.28, Wuquan 3rd Rd., Wugu Dist., New Taipei City 248,  
Taiwan (R.O.C.)
- Manufacturer** : **1. Mean Well Enterprises Co., Ltd.**  
No.28, Wuquan 3rd Rd., Wugu Dist., New Taipei City 248,  
Taiwan (R.O.C.)  
**2. Mean Well (GUANGZHOU) Electronics Co., Ltd.**  
2F, A Building, Yuean Industrial Park, Huangcun, Dongpu Town,  
TianHe District, Guangzhou, Guangdong, P.R. China  
**3. SuZhou Mean Well Technology Co., Ltd.**  
No. 77, Jian-min Road, Dong-qiao, Pan-yang Ind. Park, Huang-dai Town,  
Xiang-cheng District, Suzhou, Jiangsu 215152, P.R. China
- Product Information** : Input: 12Vdc / 1.4A; 48Vdc / 0.4A  
Output: The detailed specification, please see “Specifications” as below.
- Date of Test** : Aug. 06, 2015 (For 7A012601E-03)
- Additional Description** : **(For 7A012601E)**
- 1.) The Model Number “**NSD10-12D5; NSD10-12D12; NSD10-12D15; NSD10-48D5; NSD10-48D12; NSD10-48D15; NSD10-12S3; NSD10-12S5; NSD10-12S9; NSD10-12S12; NSD10-12S15; NSD10-48S3; NSD10-48S5; NSD10-48S9; NSD10-48S12; NSD10-48S15**” are representative selected in the test and included in this report.
  - 2.) All models are identical except for model name and O/P rating.
- (For 7A012601E-01)**
- 1.) 7A012601E-01 is a multiple report of 7A012601E, the difference is upgraded the measurement of IEC 61000-4-4 and IEC 61000-4-5, the rest parts are identical.
  - 2.) The test model is “**NSD10-12S5**” and included in this report.
- (For 7A012601E-02)**
- 1.) 7A012601E-02 is a multiple report of 7A012601E-01, the differences are updated the standard, added two manufacturers and changed the address of Applicant and Manufacturer (because of municipality change by government), therefore re-measured EN 61000-4-3 test, the rest parts are identical.
  - 2.) The Model Number “**NSD10-12D5; NSD10-12S5**” are representative selected in the test and included in this report.

**Additional Description : (For 7A012601E-03)**

- 1.) 7A012601E-03 is a multiple report of 7A012601E-02, the difference is updated the standard, therefore re-measured EN 61000-4-4 test, the rest parts are identical.
- 2.) The Model Number “**NSD10-12D5; NSD10-12S5**” are representative selected in the test and included in this report.

## 1.2 Specifications

Model No.		Output	
		Voltage (Vdc)	Current (A)
NSD10-12D5	NSD10-48D5	5	1
		-5	1
NSD10-12D12	NSD10-48D12	12	0.42
		-12	0.42
NSD10-12D15	NSD10-48D15	15	0.33
		-15	0.33
NSD10-12S3	NSD10-48S3	3.3	2.5
NSD10-12S5	NSD10-48S5	5	2
NSD10-12S9	NSD10-48S9	9	1.1
NSD10-12S12	NSD10-48S12	12	0.83
NSD10-12S15	NSD10-48S15	15	0.67

**1.3 Details of Tested Supporting System**

## 1.3.1 Load (NSD10-12D5) (Total 10W)

Full Load Watt : Load 1: 5W (5Vdc, 1A)  
Load 2: 5W (-5Vdc, 1A)

## 1.3.2 Load (NSD10-12S5)

Full Load Watt : 10W (5Vdc, 2A)



## 1.4 Test Facility

- Site Description** : ☒EMS Room
- Name of Firm** : Interocean EMC Technology Corp.
- Company web** : <http://www.ietc.com.tw>
- Location** : No. 5-2, Lin 1, Tin-Fu, Lin-Kou Dist., New Taipei City, Taiwan 244, R.O.C.
- Site Filing** :
- Federal Communication Commissions – USA  
Registration No.: 96399 (OATS 1, 2, 3 & Chamber 3)  
Designation No.: TW1020
  - Industry Canada (IC)  
OUR FILE: 46405-4437  
Registration No. (OATS 1): Site# 4437A-1  
Registration No. (OATS 3): Site# 4437A-3  
Registration No. (Chamber 3): Site# 4437A-5  
Registration No. (OATS 5): Site# 4437A-6
  - Voluntary Control Council for Interference by Information Technology Equipment (VCCI) – Japan  
Member No.: 1349  
Registration No. (Conducted Room): C-1094  
Registration No. (Conducted Room): T-1562  
Registration No. (OATS 1): R-1040; G-274
- Site Accreditation** :
- Bureau of Standards and Metrology and Inspection (BSMI) – Taiwan, R.O.C.  
Accreditation No.:  
SL2-IN-E-0026 for CNS13438 / CISPR 22  
SL2-IN-E-0026 for CNS14757-2 / IEC 62040-2  
SL2-R1-E-0026 for CNS13439 / CISPR 13  
SL2-R2-E-0026 for CNS13439 / CISPR 13  
SL2-A1-E-0026 for CNS13783-1 / CISPR 14-1  
SL2-L1-E-0026 for CNS 14115 / CISPR 15
  - Taiwan Accreditation Foundation (TAF)  
Accreditation No.: 1113
  - Vehicle Safety Certification Center (VSCC)  
Approval No.: TW16-11-0
  - TÜV NORD  
Certificate No: TNTW0801R-04

## 1.5 Configuration of EUT Setup

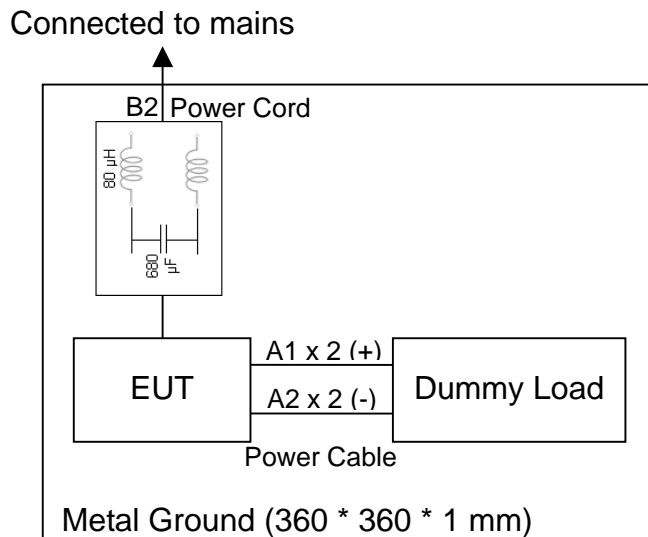

Remark: 1. The length of power cable is 0.1 m long.

### Connecting Cables:

No.	Cable	Length	Shielded	Shielded Backshell	Supported by lab.	Note
A1	Power Cable (+)	0.1 m				
A2	Power Cable (-)	0.1 m				
B2	Power Cord	0.15 m			✓	

## 2 Performance Criterion of Immunity Test

### 2.1 EN 55024

<b>General performance criteria</b>	
<b>Criterion</b>	<b>Description</b>
A	During and after the test the EUT shall continue to operate as intended without operator intervention. No degradation of performance or loss of function is allowed below a minimum performance level specified by the manufacturer when the EUT is used as intended. The performance level may be replaced by a permissible loss of performance. If the minimum performance level or the permissible performance loss is not specified by the manufacturer, then either of these may be derived from the product description and documentation, and by what the user may reasonably expect from the EUT if used as intended.
B	After the test, the EUT shall continue to operate as intended without operator intervention. No degradation of performance or loss of function is allowed, after the application of the phenomena below a performance level specified by the manufacturer, when the EUT is used as intended. The performance level may be replaced by a permissible loss of performance. During the test, degradation of performance is allowed. However, no change of operating state or stored data is allowed to persist after the test. If the minimum performance level (or the permissible performance loss) is not specified by the manufacturer, then either of these may be derived from the product description and documentation, and by what the user may reasonably expect from the EUT if used as intended.
C	During and after testing, a temporary loss of function is allowed, provided the function is self-recoverable, or can be restored by the operation of the controls or cycling of the power to the EUT by the user in accordance with the manufacturer's instructions.
<b>Particular performance criteria</b>	
<p>The particular performance criteria which are specified in the normative annexes B~H take precedence over the corresponding parts of the general performance criteria. Where particular performance criteria for specific functions are not given, then the general performance criteria shall apply.</p> <p>Annex B Data processing equipment: (Read, write and storage of data; Data display; Data input; Data printing; Data processing)</p> <p>Annex C Local area networks (LAN)</p> <p>Annex D Printers and plotters</p> <p>Annex E Copying machines</p> <p>Annex F Automatic teller machines (ATM)</p> <p>Annex G Point of sale terminals (POST)</p> <p>Annex H xDSL Terminal equipment</p>	

**2.2 EN 61204-3**

<b>Criterion</b>	<b>Basic Specifications</b>	<b>Remarks</b>
A	No loss of function or performance during the test	Operating as intended within specified tolerance
B	Temporary loss of function or performance during the test Self-recoverable	Degradation of performance shall be specified by the manufacturer PSU shall continue to operate as intended after the test
C	Loss of function or performance Not self-recoverable Not damaged	Any resettable condition allowed including shut-down

**2.3 EN 61000-6-1**

<b>Criterion</b>	<b>Description</b>
A	The apparatus shall continue to operate as intended during and after the test. No degradation of performance or loss of function is allowed below a performance level specified by the manufacturer, when the apparatus is used as intended. The performance level may be replaced by a permissible loss of performance. If the minimum performance level or the permissible performance loss is not specified by the manufacturer, either of these may be derived from the product description and documentation and what the user may reasonably expect from the apparatus if used as intended.
B	The apparatus shall continue to operate as intended after the test. No degradation of performance or loss of function is allowed below a performance level specified by the manufacturer, when the apparatus is used as intended. The performance level may be replaced by a permissible loss of performance. During the test, degradation of performance is however allowed. No change of actual operating state or stored data is allowed. If the minimum performance level or the permissible performance loss is not specified by the manufacturer, either of these may be derived from the product description and documentation and what the user may reasonably expect from the apparatus if used as intended.
C	Temporary loss of function is allowed, provided the function is self-recoverable or can be restored by the operation of the controls.

### 3 Electrical Fast Transient/Burst Immunity Test (EN 61000-4-4)

#### 3.1 Instrument

Instrument	Manufacturer	Model	Serial No.	Next Cal. Date
EMC Test System	EMC PARTNER	TRANSIENT-2000	812	2015/09/16

Note: The above equipments are within the valid calibration period.

#### 3.2 Block Diagram of Test Configuration

For Power Ports.

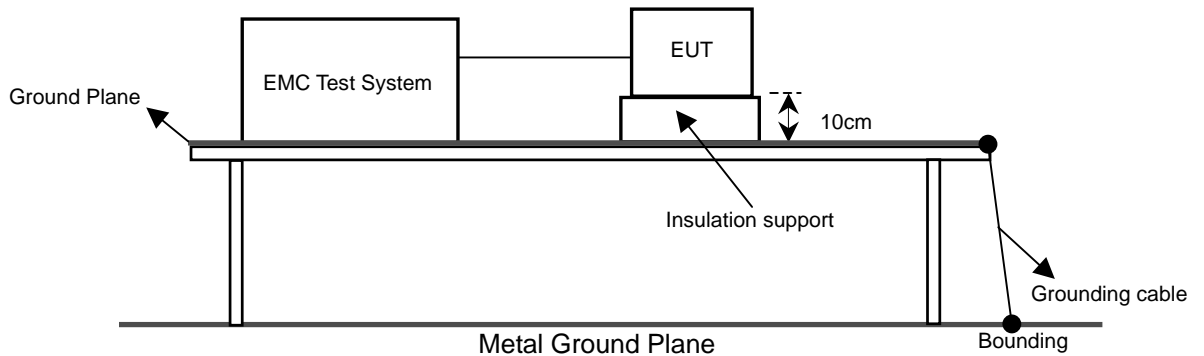

#### 3.3 Test Levels

Open circuit output test voltage and repetition rate of the impulses				
Level	On power port, PE		On I/O (input/output) signal, data and control ports	
	Voltage peak kV	Repetition rate kHz	Voltage peak kV	Repetition rate kHz
1	0,5	5 or 100	0,25	5 or 100
2	1	5 or 100	0,5	5 or 100
3	2	5 or 100	1	5 or 100
4	4	5 or 100	2	5 or 100
X <sup>a</sup>	Special	Special	Special	Special

NOTE 1: Use of 5 kHz repetition rates is traditional; however, 100 kHz is closer to reality. Product committees should determine which frequencies are relevant for specific products or product types.

NOTE 2: With some products, there may be no clear distinction between power ports and I/O ports, in which case it is up to product committees to make this determination for test purposes.

<sup>a</sup> "X" is an open level. The level has to be specified in the dedicated equipment specification.

### 3.4 Test Requirement

5 kHz Repetition frequency

3.4.1 EN 61000-4-4 (EN 55024) require:

- $\pm 1.0$  kV input AC power ports.
- $\pm 0.5$  kV input DC power ports.

Performance criterion: B

3.4.2 EN 61000-4-4 (EN 61204-3) require: (For Low Severity Levels)

- $\pm 1.0$  kV input AC power ports.
- $\pm 0.5$  kV Input DC power ports.

Performance criterion: B

3.4.3 EN 61000-4-4 (EN 61000-6-1) require:

- $\pm 1.0$  kV input AC power ports.
- $\pm 0.5$  kV input DC power ports.

Performance criterion: B

### 3.5 Configuration of Measurement

3.5.1 The EUT and the auxiliary equipment were placed on a wooden table of 0.8 meters height. The size of ground plane is greater than 1m×1m and project beyond the EUT by at least 0.1m on all sides. The ground plane is connected to the protective earth.

3.5.2 The EUT was connected to the power mains through a coupling device that directly couples the EFT interference signal. Each of the Line, Neutral and Protective Earth (PE) conductors was impressed with burst noise for 1 minute. Both the voltage polarities were applied for each test level. The length of the signal and power lines between the coupling device and the EUT shall be  $0,5\text{m} \pm 0,05\text{m}$ .

**3.6 Test Result**

Temperature: 25.1 °C ; Humidity: 41 % ; Atm pres: 986 hPa ; Test Engineer: Evans

**PASS.**

**(For all of the standard) Test Mode: Full Load (NSD10-12D5) (Input: DC 30V)**

3.6.1 The performance criterion after tested EN 61000-4-4 (EN 55024):

- ±1.0 kV input DC power port: Line  
Performance criterion:       **A**       **B**       **C**
- ±1.0 kV input DC power port: Neutral  
Performance criterion:       **A**       **B**       **C**
- ±1.0 kV input DC power port: Line + Neutral  
Performance criterion:       **A**       **B**       **C**

3.6.2 The performance criterion after tested EN 61000-4-4 (EN 61204-3):

- ±1.0 kV input DC power port: Line  
Performance criterion:       **A**       **B**       **C**
- ±1.0 kV input DC power port: Neutral  
Performance criterion:       **A**       **B**       **C**
- ±1.0 kV input DC power port: Line + Neutral  
Performance criterion:       **A**       **B**       **C**

3.6.3 The performance criterion after tested EN 61000-4-4 (EN 61000-6-1):

- ±1.0 kV input DC power port: Line  
Performance criterion:       **A**       **B**       **C**
- ±1.0 kV input DC power port: Neutral  
Performance criterion:       **A**       **B**       **C**
- ±1.0 kV input DC power port: Line + Neutral  
Performance criterion:       **A**       **B**       **C**

**(For all of the standard) Test Mode: Full Load (NSD10-12S5) (Input: DC 30V)**

3.6.4 The performance criterion after tested EN 61000-4-4 (EN 55024):

- ±1.0 kV input DC power port: Line  
Performance criterion:       **A**       **B**       **C**
- ±1.0 kV input DC power port: Neutral  
Performance criterion:       **A**       **B**       **C**
- ±1.0 kV input DC power port: Line + Neutral  
Performance criterion:       **A**       **B**       **C**

3.6.5 The performance criterion after tested EN 61000-4-4 (EN 61204-3):

- ±1.0 kV input DC power port: Line  
Performance criterion:       **A**       **B**       **C**
- ±1.0 kV input DC power port: Neutral  
Performance criterion:       **A**       **B**       **C**
- ±1.0 kV input DC power port: Line + Neutral  
Performance criterion:       **A**       **B**       **C**

3.6.6 The performance criterion after tested EN 61000-4-4 (EN 61000-6-1):

- ±1.0 kV input DC power port: Line  
Performance criterion:       **A**       **B**       **C**
- ±1.0 kV input DC power port: Neutral  
Performance criterion:       **A**       **B**       **C**
- ±1.0 kV input DC power port: Line + Neutral  
Performance criterion:       **A**       **B**       **C**



# Test Report



(Declaration of Conformity)

for

Electromagnetic Compatibility

of

Product : **Switching Power Supply**

Trade Name : MEAN WELL

Model Number : NSD10-xyz  
(x=12 or 48, y=S or D, z=3, 5, 9, 12, 15)

Prepared for

**MEAN WELL ENTERPRISES CO., LTD.**

No.28, Wuquan 3rd Rd., Wugu Dist., New Taipei City 248,  
Taiwan (R.O.C.)

TEL: +886 2 2299 6100

FAX: +886 2 2299 6200

Prepared by

**Interocean EMC Technology Corp.**

No.5-2, Lin 1, Tin-Fu Tsun, Lin-Kou Hsiang,  
Taipei County 244, Taiwan, R.O.C.

TEL.: +886 2 2600 6861

FAX.: +886 2 2600 6859

**Remark:**

The test report consists of **11** pages in total. It shall not be reproduced except in full, without the written approval of IETC. This document may be altered or revised by IETC only, and shall be noted in the revision section of the document.

The test result in this report is only subjected to the test sample.

# Table of Contents

<b>1</b>	<b>General Information</b>	<b>4</b>
1.1	Description of Equipment Under Test	4
1.2	Specifications	5
1.3	Details of Tested Supporting System	6
1.4	Test Facility	7
1.5	Measurement Uncertainty	8
<b>2</b>	<b>Performance Criterion of Immunity Test</b>	<b>9</b>
2.1	EN 61000-6-1	9
<b>3</b>	<b>Radio-Frequency, Electromagnetic Field Immunity Test (EN 61000-4-3)</b>	<b>10</b>
3.1	Instrument	10
3.2	Block Diagram of Test Configuration	10
3.3	Test Levels	10
3.4	Test Requirement	11
3.5	Configuration of Measurement	11
3.6	Test Result	11

# Statement of Compliance

**Applicant:** MEAN WELL ENTERPRISES CO., LTD.

**Manufacturer:** 1. Mean Well Enterprises Co., Ltd.  
2. MEAN WELL (GUANGZHOU) ELECTRONICS CO., LTD.  
3. SuZhou Mean Well Technology Co., Ltd.

**Product:** Switching Power Supply

**Model No.:** NSD10-xyz  
(x=12 or 48, y=S or D, z=3, 5, 9, 12, 15)

**Tested Power Supply:** 12Vdc / 1.4A; 48Vdc / 0.4A

**Date of Final Test:** Aug. 21, 2012

**Revision of Report:** Rev. 00

## Measurement Procedures and Standards Used :

### Emission:

- EN 55011: 2009+A1: 2010
- EN 55022: 2010
- EN 61000-6-3: 2007+A1: 2011
- EN 61000-3-2: 2006+A1: 2009+A2: 2009
- EN 61000-3-3: 2008

### Immunity:

- EN 55024: 2010
- EN 61204-3: 2000
- EN 61000-6-1: 2007
- EN 61000-4-2: 2009
- EN 61000-4-3: 2006+A1: 2008+A2: 2010
- EN 61000-4-4: 2004+A1: 2010
- EN 61000-4-5: 2006
- EN 61000-4-6: 2009
- EN 61000-4-8: 2010
- EN 61000-4-11: 2004

The measurement results in this test report were performed at Interocean EMC Technology Corp. the responsibility of measurement result is only subjected to the tested sample. This report shows the EUT is technically compliance with the above official standards. This report shall not be partial reproduced without written approval by Interocean EMC Technology Corporation.

Report Issued: 2012/08/27

Project Engineer: Jason Huang  
Jason Huang

Approved: Benson Tsai  
Benson Tsai

## 1 General Information

### 1.1 Description of Equipment Under Test

- Product** : Switching Power Supply
- Model Number** : NSD10-xyz  
(x=12 or 48, y=S or D, z=3, 5, 9, 12, 15)
- Applicant** : **MEAN WELL ENTERPRISES CO., LTD.**  
No.28, Wuquan 3rd Rd., Wugu Dist., New Taipei City 248,  
Taiwan (R.O.C.)
- Manufacturer** : **1. Mean Well Enterprises Co., Ltd.**  
No.28, Wuquan 3rd Rd., Wugu Dist., New Taipei City 248,  
Taiwan (R.O.C.)  
**2. MEAN WELL (GUANGZHOU) ELECTRONICS CO., LTD.**  
2nd Floor, No.A Building, Yuean Ind. Park, Dongpu Town,  
TianHe District, Guangzhou City, P.R. China  
**3. SuZhou Mean Well Technology Co., Ltd.**  
No. 77, Jian-min Road, Dong-qiao, Pan-yang Ind. Park, Huang-dai Town,  
Xiang-cheng District, Suzhou, Jiangsu 215152, P.R. China
- Product Information** : Input: 12Vdc / 1.4A; 48Vdc / 0.4A  
Output: The detailed specification, please see "Specifications" as below.
- Date of Test** : Aug. 21, 2012 (For 7A012601E-02)
- Additional Description** : **(For 7A012601E)**
- 1.) The Model Number "**NSD10-12D5; NSD10-12D12; NSD10-12D15; NSD10-48D5; NSD10-48D12; NSD10-48D15; NSD10-12S3; NSD10-12S5; NSD10-12S9; NSD10-12S12; NSD10-12S15; NSD10-48S3; NSD10-48S5; NSD10-48S9; NSD10-48S12; NSD10-48S15**" are representative selected in the test and included in this report.
  - 2.) All models are identical except for model name and O/P rating.
- (For 7A012601E-01)**
- 1.) 7A012601E-01 is a multiple report of 7A012601E, the difference is upgraded the measurement of IEC 61000-4-4 and IEC 61000-4-5, the rest parts are identical.
  - 2.) The test model is "**NSD10-12S5**" and included in this report.
- (For 7A012601E-02)**
- 1.) 7A012601E-02 is a multiple report of 7A012601E-01, the differences are updated the standard, added two manufacturers and changed the address of Applicant and Manufacturer (because of municipality change by government), therefore re-measured EN 61000-4-3 test, the rest parts are identical.
  - 2.) The Model Number "**NSD10-12D5; NSD10-12S5**" are representative selected in the test and included in this report.

## 1.2 Specifications

Model No.		Output	
		Voltage (Vdc)	Current (A)
NSD10-12D5	NSD10-48D5	5	1
		-5	1
NSD10-12D12	NSD10-48D12	12	0.42
		-12	0.42
NSD10-12D15	NSD10-48D15	15	0.33
		-15	0.33
NSD10-12S3	NSD10-48S3	3.3	2.5
NSD10-12S5	NSD10-48S5	5	2
NSD10-12S9	NSD10-48S9	9	1.1
NSD10-12S12	NSD10-48S12	12	0.83
NSD10-12S15	NSD10-48S15	15	0.67

### 1.3 Details of Tested Supporting System

#### 1.3.1 LOAD (NSD10-12D5)

FULL LOAD WATT : 5W (5Vdc, 1A), 5W (-5Vdc, 1A)

#### 1.3.2 LOAD (NSD10-12S5)

FULL LOAD WATT : 10W (5Vdc, 2A)

## 1.4 Test Facility

- Site Description** : ☑EMS Site
- Name of Firm** : Interocean EMC Technology Corp.
- Company web** : <http://www.ietc.com.tw>
- Site 1, 2, 3 Location** : No.5-2, Lin 1, Tin-Fu Tsun, Lin-Kou Hsiang, Taipei County, Taiwan, R.O.C.
- Site Filing** :
- Federal Communication Commissions – USA  
Registration No.: 96399 (OATS 1 & 2)  
Registration No.: 518958 (OATS 3)  
Designation No.: TW1020
  - Voluntary Control Council for Interference by Information Technology Equipment (VCCI) – Japan  
Member No.: 1349  
Registration No. (Conducted Room): C-1094  
Registration No. (Conducted Room): T-1562  
Registration No. (OATS 1): R-1040; G-274  
Registration No. (OATS 2): R-1041
  - Industry Canada (IC)  
OUR FILE: 46405-4437 Submission: 145171  
Registration No. (OATS 1): Site# 4437A-1  
Registration No. (OATS 2): Site# 4437A-2  
Registration No. (OATS 3): Site# 4437A-3
- Site Accreditation** :
- Bureau of Standards and Metrology and Inspection (BSMI) – Taiwan, R.O.C.  
Accreditation No.:  
SL2-IN-E-0026 for CNS13438 / CISPR22  
SL2-R1-E-0026 for CNS13439 / CISPR13  
SL2-R2-E-0026 for CNS13439 / CISPR13  
SL2-A1-E-0026 for CNS13783-1 / CISPR14-1  
SL2-L1-E-0026 for CNS 14115 / CISPR 15
  - Taiwan Accreditation Foundation (TAF)  
Accreditation No.: 1113
  - TÜV NORD  
Certificate No: TNTW0801R-04



## 1.5 Measurement Uncertainty

Item	Value
Conduction 1:	
Power Line Conducted Emission (9kHz~30MHz)	2.4 dB
Telecom. Port Conducted Emission / ISN-T4 (150kHz~30MHz)	2.6 dB
Telecom. Port Conducted Emission / ISN-T8 (150kHz~30MHz)	2.6 dB
Telecom. Port Conducted Emission / Current Probe (150kHz~30MHz)	2.8 dB
Radiated Electromagnetic disturbance / Loop Antenna (9kHz~30MHz)	4.8 dB
Conduction 2:	
Power Line Conducted Emission (9kHz~30MHz)	2.4 dB
Telecom. Port Conducted Emission / ISN-T4 (150kHz~30MHz)	2.6 dB
Telecom. Port Conducted Emission / ISN-T8 (150kHz~30MHz)	2.6 dB
Telecom. Port Conducted Emission / Current Probe (150kHz~30MHz)	2.8 dB
Disturbance Power Emission (30MHz~300MHz)	3.1 dB
Click disturbances Emission (150kHz~30MHz)	2.4 dB
OATS 1:	
Radiated Emission Test (30MHz~1GHz)	4.2 dB
Radiated Emission Test (1GHz~6GHz)	3.2 dB
OATS 2:	
Radiated Emission Test (30MHz~1GHz)	4.2 dB
Radiated Emission Test (1GHz~6GHz)	3.2 dB
OATS 3:	
Radiated Emission Test (30MHz~1GHz)	4.2 dB
Radiated Emission Test (1GHz~6GHz)	3.2 dB
Conducted Immunity Room:	
Conducted Immunity Test / CDN-M2	1.3 dB
Conducted Immunity Test / CDN-M3	1.3 dB
Conducted Immunity Test / EM Clamp	3.2 dB



## 2 Performance Criterion of Immunity Test

### 2.1 EN 61000-6-1

Criterion	Description
A	<p>The apparatus shall continue to operate as intended during and after the test. No degradation of performance or loss of function is allowed below a performance level specified by the manufacturer, when the apparatus is used as intended.</p> <p>The performance level may be replaced by a permissible loss of performance. If the minimum performance level or the permissible performance loss is not specified by the manufacturer, either of these may be derived from the product description and documentation and what the user may reasonably expect from the apparatus if used as intended.</p>
B	<p>The apparatus shall continue to operate as intended after the test. No degradation of performance or loss of function is allowed below a performance level specified by the manufacturer, when the apparatus is used as intended.</p> <p>The performance level may be replaced by a permissible loss of performance. During the test, degradation of performance is however allowed. No change of actual operating state or stored data is allowed. If the minimum performance level or the permissible performance loss is not specified by the manufacturer, either of these may be derived from the product description and documentation and what the user may reasonably expect from the apparatus if used as intended.</p>
C	<p>Temporary loss of function is allowed, provided the function is self-recoverable or can be restored by the operation of the controls.</p>

### 3 Radio-Frequency, Electromagnetic Field Immunity Test (EN 61000-4-3)

#### 3.1 Instrument

Instrument	Manufacturer	Model	Serial No.	Next Cal. Date
Signal Generator	R&S	SM300	101279	2012/10/18
RF Power Amplifier	Frankonia	FLG-200B	1038	2013/02/19
RF Power Amplifier	Frankonia	FLG-50C	1013	2013/02/19
Bilog Antenna	Frankonia	BTA-M	06012M	2013/02/19

Note: The above equipments are within the valid calibration period.

#### 3.2 Block Diagram of Test Configuration

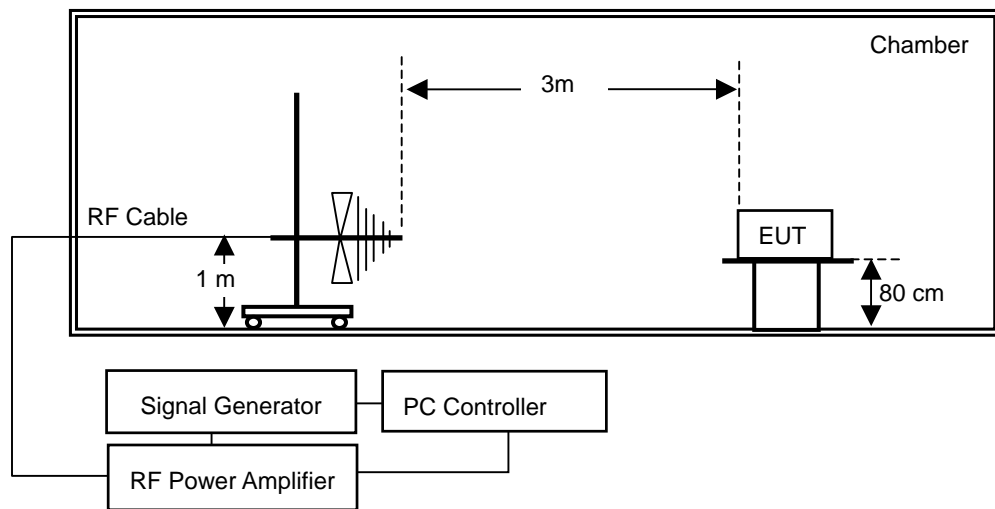

#### 3.3 Test Levels

Level	Test field strength (V/m)
1	1
2	3
3	10
4	30
X	Special

### 3.4 Test Requirement

The frequency steps: 1%, Log sweep, Dwell time: 3.0 sec.

3.4.1 EN 61000-4-3 (EN 61000-6-1) require:

- Frequency range: 80 to 1000 MHz, Field strength: **3** V/m, 80% AM (1kHz),
  - Frequency range: 1400 to 2000 MHz, Field strength: **3** V/m, 80% AM (1kHz),
  - Frequency range: 2000 to 2700 MHz, Field strength: **1** V/m, 80% AM (1kHz),
- Performance criterion: A

### 3.5 Configuration of Measurement

- 3.5.1 Before testing, the intensity of the established field strength was checked by placing the field sensor at a calibration grid point, and with the field generating antenna and cables in the same positions as used for the calibration, the forward and reverse power were measured. The forward power needed to give the calibrated field was evaluated.
- 3.5.2 The EUT was placed on a non-metallic table 0.8m above the reference ground plane (RGP) and was operated according to its specified operating mode.
- 3.5.3 Ferrite tiles/ absorbers were placed on the RGP between the EUT and the antenna to reduce the reflections from the RGP.
- 3.5.4 The distance between antenna and EUT is 3 meters.
- 3.5.5 During the test EUT performance has been monitoring by CCD camera.

### 3.6 Test Result

Temperature: 23.9 °C ; Humidity: 42 % ; Atm pres: 101 Kpa ; Test Engineer: Jason

**PASS.**

3.6.1 The performance criterion after tested EN 61000-4-3 (EN 61000-6-1):

**(For Model No.: NSD10-12D5 and NSD10-12S5)**

- Frequency range: **1400** to **2000** MHz, Field strength: **3** V/m, 80% AM (1kHz),  
Performance criterion:  **A**     **B**     **C**
- Frequency range: **2000** to **2700** MHz, Field strength: **1** V/m, 80% AM (1kHz),  
Performance criterion:  **A**     **B**     **C**

# Test Report



(Declaration of Conformity)

for

Electromagnetic Compatibility

of

**E.U.T.: Switching Power Supply**

Trade Name: MEAN WELL

Model Number: NSD10-xyz

(x=12 or 48, y=S or D, z=3, 5, 9, 12, 15)

Prepared for

**MEAN WELL ENTERPRISES CO., LTD.**

No. 28, Wu-Chuan 3<sup>rd</sup> Road, Wu Ku Ind. Park,

Taipei Hsien, Taiwan

TEL: +886 2 2299 6100

FAX: +886 2 2299 6200

Prepared by

**Interocean EMC Technology Corp.**

244 No.5-2, Lin 1, Tin-Fu Tsun, Lin-Kou Hsiang,

Taipei County, Taiwan 244, R.O.C.

TEL.: +886 2 2600 6861

FAX.: +886 2 2600 6859

**Remark:**

1. The test report consists of 12 pages in total. It shall not be reproduced except in full, without the written approval of IETC. This document may be altered or revised by IETC only, and shall be noted in the revision section of the document. The test results in the report only to the tested sample.
2. The report must not be used by the client to claim product certification, approval, or endorsement by NVLAP, NIST, or any agency of the Federal Government.

# Table of Contents

<b>1</b>	<b>General Information</b>	<b>4</b>
1.1	Description of Equipment Under Test	4
1.2	Measured Mode	4
<b>2</b>	<b>Performance Criterion of Immunity Test</b>	<b>5</b>
2.1	EN 55024 & ENV 50204	5
2.2	EN 61204-3	5
2.3	EN 61000-6-1	6
<b>3</b>	<b>Electrical Fast Transient/Burst Immunity Test (IEC 61000-4-4)</b>	<b>7</b>
3.1	Instrument	7
3.2	Block Diagram of Test Configuration	7
3.3	Test Levels	7
3.4	Test Requirement	8
3.5	Configuration of Measurement	8
3.6	Test Result	9
<b>4</b>	<b>Surge Immunity Test (IEC 61000-4-5)</b>	<b>10</b>
4.1	Instrument	10
4.2	Block Diagram of Test Configuration	10
4.3	Test Levels	10
4.4	Test Requirement	11
4.5	Configuration of Measurement	11
4.6	Test Result	12

## Statement of Compliance

**Applicant:** MEAN WELL ENTERPRISES CO., LTD.  
**Manufacturer:** MEAN WELL ENTERPRISES CO., LTD.  
**EUT Description:** Switching Power Supply  
**Model No.:** NSD10-xyz  
(x=12 or 48, y=S or D, z=3, 5, 9, 12, 15)  
**Tested Power Supply:** 12Vdc / 1.4A; 48Vdc / 0.4A  
**Date of Final Test:** Sep. 26, 2007

### Measurement Procedures and Standards Used :

#### Emission:

- EN 55011: 1998+A1: 1999+A2: 2002  
 EN 55022: 1998+A1: 2000+A2: 2003  
 EN 61000-6-3: 2001+A11: 2004  
 EN 61000-3-2: 2000+A2: 2005  
 EN 61000-3-3: 1995+A1: 2001

#### Immunity:

- EN 55024: 1998+A1: 2001+A2: 2003  
 IEC 61000-4-2: 1995+A1: 1998+A2: 2000  
 IEC 61000-4-3: 2006  
 IEC 61000-4-4: 2004  
 IEC 61000-4-5: 2005  
 IEC 61000-4-6: 2003+A1: 2004+A2: 2006  
 IEC 61000-4-8: 1993+A1: 2000  
 IEC 61000-4-11: 2004  
 ENV 50204: 1995
- EN 61000-6-1: 2001  
 IEC 61000-4-2: 1995+A1: 1998+A2: 2000  
 IEC 61000-4-3: 2006  
 IEC 61000-4-4: 2004  
 IEC 61000-4-5: 2005  
 IEC 61000-4-6: 2003+A1: 2004+A2: 2006  
 IEC 61000-4-8: 1993+A1: 2000  
 IEC 61000-4-11: 2004
- EN 61204-3: 2000  
 IEC 61000-4-2: 1995+A1: 1998+A2: 2000  
 IEC 61000-4-3: 2006  
 IEC 61000-4-4: 2004  
 IEC 61000-4-5: 2005  
 IEC 61000-4-6: 2003+A1: 2004+A2: 2006  
 IEC 61000-4-11: 2004

The device described above was tested by Interocean EMC Technology Corporation to determine the maximum emission levels emanated from the device and severity levels of the device endure and its performance criterion. The measurement results are contained in this test report and Interocean EMC Technology Corp assumes full responsibility for the accuracy and completeness of these measurements. This report shows the EUT is technically compliance with the above official standards. This report applies to the above sample only and shall not be reproduced in part without written approval of Interocean EMC Technology Corporation.

Report Issued: 2007/10/31

Test Engineer: Sunny Chen <sup>2007</sup> 1031  
Sunny Chen

Checked: Benson Tsai <sup>2007</sup> 1031  
Benson Tsai

Approved: Mike Huang <sup>2007</sup> 1031  
Mike Huang

## 1 General Information

### 1.1 Description of Equipment Under Test

- Equipment Under Test** : Switching Power Supply
- Model Number** : NSD10-xyz  
(x=12 or 48, y=S or D, z=3, 5, 9, 12, 15)
- Serial Number** : N/A
- Type of Sample Tested** : Proto-type    Pre-Production    Mass Production
- Applicant** : **MEAN WELL ENTERPRISES CO., LTD.**  
No. 28, Wu-Chuan 3<sup>rd</sup> Road, Wu Ku Ind. Park, Taipei Hsien, Taiwan
- Manufacturer** : **MEAN WELL ENTERPRISES CO., LTD.**  
No. 28, Wu-Chuan 3<sup>rd</sup> Road, Wu Ku Ind. Park, Taipei Hsien, Taiwan
- Product information** : Input: 12Vdc / 1.4A; 48Vdc / 0.4A  
Power cord: Non-shielded Detachable, 0.2m w/o core  
Output: The detail specification, please refer to "Specifications Description of Output Voltage / Current" of original test report 7A012601E.
- Date of Receipt of Sample** : Sep. 21, 2007
- Date of Test** : Sep. 26, 2007
- Description of E.U.T.** : (For 7A012601E)  
1.) The EUT is Switching Power Supply.  
2.) The Model Number "NSD10-12D5; NSD10-12D12; NSD10-12D15; NSD10-48D5; NSD10-48D12; NSD10-48D15; NSD10-12S3; NSD10-12S5; NSD10-12S9; NSD10-12S12; NSD10-12S15; NSD10-48S3; NSD10-48S5; NSD10-48S9; NSD10-48S12; NSD10-48S15" are representative selected in the test and included in this report.  
3.) The difference for all models include in this report are only Model No., Output Voltage and Output Current, the rest parts are identical.
- (For 7A012601E-01)  
1.) 7A012601E-01 is a multiple report of 7A012601E, the difference is upgraded the measurement of IEC 61000-4-4 and IEC 61000-4-5, the rest parts are identical.

### 1.2 Measured Mode

- 1.2.1 The test mode for preliminary test is as following:
- Mode 1: FULL LOAD (NSD10-12S5)
- 1.2.2 For IEC 61000-4-4 and IEC 61000-4-5 tests, selected the **mode 1** for final test.

## 2 Performance Criterion of Immunity Test

### 2.1 EN 55024 & ENV 50204

Criterion	Description
A	<p>The equipment shall continue to operate as intended without operator intervention. No degradation of performance or loss of function is allowed below a performance level specified by the manufacturer when the equipment is used as intended. The performance level may be replaced by a permissible loss of performance. If the minimum performance level or the permissible performance loss is not specified by the manufacturer, then either of these may be derived from the product description and documentation, and by what the use may reasonably expect from the equipment if used as intended.</p>
B	<p>After the test, the equipment shall continue to operate as intended without operator intervention. No degradation of performance or loss of function is allowed, after the application of the phenomena below a performance level specified by the manufacturer, when the equipment is used as intended. The performance level may be replaced by a permissible loss of performance.</p> <p>During the test, degradation of performance is allowed. However, no change of operating state or stored data is allowed to persist after the test.</p> <p>If the minimum performance level (or the permissible performance loss) is not specified by the manufacturer, then either of these may be derived from the product description and documentation, and by what the user may reasonable expect from the equipment if used as intended.</p>
C	<p>Loss of function is allowed, provided the function is self-recoverable, or can be restored by the operation of the controls by the user in accordance with the manufacturer’s instructions.</p> <p>Functions, and/or information stored in non-volatile memory, or protected by a battery backup, shall not be lost.</p>

### 2.2 EN 61204-3

Criterion	Basic Specifications	Remarks
A	No loss of function or performance during the test	Operating as intended within specified tolerance
B	Temporary loss of function or performance during the test Self-recoverable	Degradation of performance shall be specified by the manufacturer PSU shall continue to operate as intended after the test
C	Loss of function or performance Not self-recoverable Not damaged	Any resettable condition allowed including shut-down



**2.3 EN 61000-6-1**

<b>Criterion</b>	<b>Description</b>
A	<p>The apparatus shall continue to operate as intended during and after the test. No degradation of performance or loss of function is allowed below a performance level specified by the manufacturer, when the apparatus is used as intended.</p> <p>The performance level may be replaced by a permissible loss of performance. If the minimum performance level or the permissible performance loss is not specified by the manufacturer, either of these may be derived from the product description and documentation and what the user may reasonably expect from the apparatus if used as intended.</p>
B	<p>The apparatus shall continue to operate as intended after the test. No degradation of performance or loss of function is allowed below a performance level specified by the manufacturer, when the apparatus is used as intended.</p> <p>The performance level may be replaced by a permissible loss of performance. During the test, degradation of performance is however allowed. No change of actual operating state or stored data is allowed. If the minimum performance level or the permissible performance loss is not specified by the manufacturer, either of these may be derived from the product description and documentation and what the user may reasonably expect from the apparatus if used as intended.</p>
C	<p>Temporary loss of function is allowed, provided the function is self-recoverable or can be restored by the operation of the controls.</p>

### 3 Electrical Fast Transient/Burst Immunity Test (IEC 61000-4-4)

#### 3.1 Instrument

Instrument	Manufacturer	Model	Serial No.	Last Calibration
EMC Pro System	KeyTek	EMC Pro	0003231	2007/03/16
EFT Clamp	KeyTek	PRO-CCL-C	0003198	N. C. R.

Note: All instrument upon which need to be calibrated are within calibration period of 1 year.

#### 3.2 Block Diagram of Test Configuration

Configuration of Instrument Setup.

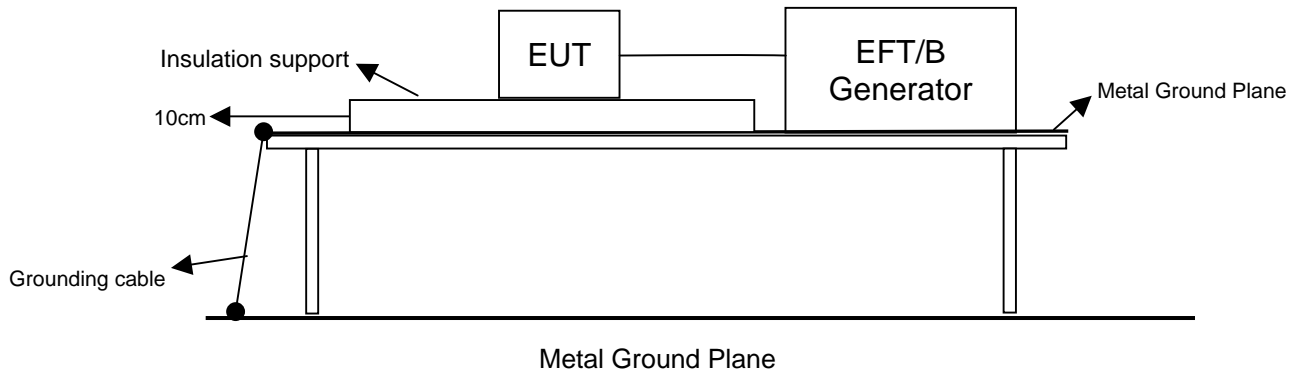

#### 3.3 Test Levels

##### 3.3.1 Test Levels

Open circuit output test voltage and repetition rate of the impulses				
Level	On power port, PE		On I/O (input/output) signal, data and control ports	
	Voltage peak kV	Repetition rate kHz	Voltage peak kV	Repetition rate kHz
1	0,5	5 or 100	0,25	5 or 100
2	1	5 or 100	0,5	5 or 100
3	2	5 or 100	1	5 or 100
4	4	5 or 100	2	5 or 100
X <sup>a</sup>	Special	Special	Special	Special

NOTE 1: Use of 5 kHz repetition rates is traditional; however, 100 kHz is closer to reality. Product committees should determine which frequencies are relevant for specific products or product types.

NOTE 2: With some products, there may be no clear distinction between power ports and I/O ports, in which case it is up to product committees to make this determination for test purposes.

<sup>a</sup> "X" is an open level. The level has to be specified in the dedicated equipment specification.

### 3.4 Test Requirement

- 3.4.1 IEC 61000-4-4 (EN 55024) require:  
5 kHz Repetition frequency  
  $\pm 0.5$  kV input DC power ports.  
Performance criterion: B
- 3.4.2 IEC 61000-4-4 (EN 61204-3) require:  
5 kHz Repetition frequency  
  $\pm 0.5$  kV input DC power ports.  
Performance criterion: B
- 3.4.3 IEC 61000-4-4 (EN 61000-6-1) require:  
5 kHz Repetition frequency  
  $\pm 0.5$  kV input DC power ports.  
Performance criterion: B

### 3.5 Configuration of Measurement

- 3.5.1 The EUT and the auxiliary equipment were placed on a wooden table of 0.8 meters height. The size of ground plane is greater than 1m $\times$ 1m and project beyond the EUT by at least 0.1m on all sides. The ground plane is connected to the protective earth.
- 3.5.2 The EUT was connected to the power mains through a coupling device that directly couples the EFT interference signal. Each of the Line, Neutral and Protective Earth (PE) conductors was impressed with burst noise for 1 minute. Both the voltage polarities were applied for each test level. The length of power cord between the coupling device and the EUT was less than 1 meter.

### 3.6 Test Result

**PASS.**

3.6.1 The performance criterion after tested IEC 61000-4-4 (EN 55024):

- ±1.0 kV input DC power ports: Line  
Performance criterion:       **A**       **B**       **C**
- ±1.0 kV input DC power ports: Neutral  
Performance criterion:       **A**       **B**       **C**
- ±1.0 kV input DC power ports: L+N  
Performance criterion:       **A**       **B**       **C**

3.6.2 The performance criterion after tested IEC 61000-4-4 (EN 61204-3):

- ±1.0 kV input DC power ports: Line  
Performance criterion:       **A**       **B**       **C**
- ±1.0 kV input DC power ports: Neutral  
Performance criterion:       **A**       **B**       **C**
- ±1.0 kV input DC power ports: L+N  
Performance criterion:       **A**       **B**       **C**

3.6.3 The performance criterion after tested IEC 61000-4-4 (EN 61000-6-1):

- ±1.0 kV input DC power ports: Line  
Performance criterion:       **A**       **B**       **C**
- ±1.0 kV input DC power ports: Neutral  
Performance criterion:       **A**       **B**       **C**
- ±1.0 kV input DC power ports: L+N  
Performance criterion:       **A**       **B**       **C**

## 4 Surge Immunity Test (IEC 61000-4-5)

### 4.1 Instrument

Instrument	Manufacturer	Model	Serial No.	Last Calibration
EMC Pro Systems	KeyTek	EMC Pro	0003234	2007/03/22
Surge Telecom Box	KeyTek	CM-TELCD	0202316	N. C. R.

Note: All instrument upon which need to be calibrated are within calibration period of 1 year.

### 4.2 Block Diagram of Test Configuration

Configuration of Instrument Setup.

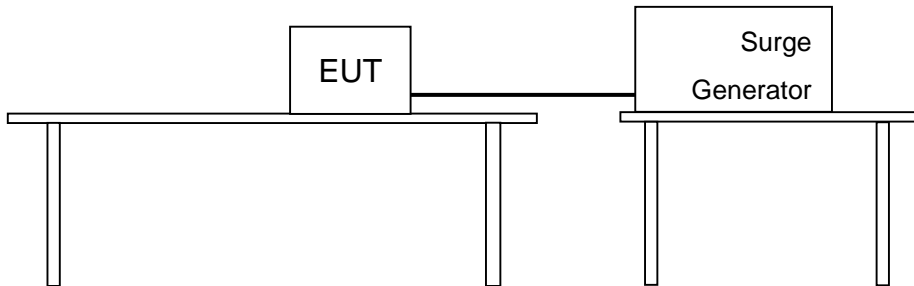

### 4.3 Test Levels

#### 4.3.1 Test Levels

Level	Open-circuit test voltage (kV) Line to earth	Open-circuit test voltage (kV) Line to line
1	0.5	--
2	1.0	0.5
3	2.0	1.0
4	4.0	2.0
X	Special	--

NOTE: x is an open class. This level can be specified in the product specification.

#### 4.4 Test Requirement

4.4.1 IEC 61000-4-5 (EN 55024) require:

Input DC power ports:  $\pm 0.5\text{kV}$ (peak): line to line, 1.2/50 (8/20) Tr/Th us

Performance criterion: **B**

4.4.2 IEC 61000-4-5 (EN 61204-3) require:

Input DC power ports:  $\pm 0.5\text{kV}$ (peak): line to line, 1.2/50 (8/20) Tr/Th us

Performance criterion: **B**

4.4.3 IEC 61000-4-5 (EN 61000-6-1) require:

Input DC power ports:  $\pm 0.5\text{kV}$ (peak): line to line, 1.2/50 (8/20) Tr/Th us

Performance criterion: **B**

#### 4.5 Configuration of Measurement

4.5.1 The EUT and the auxiliary equipment were placed on a table of 0.8m heights above a metal ground reference plane. The size of ground plane is greater than 1m×1m and project beyond the EUT by at least 0.1m on all sides. The ground plane is connected to the protective earth. The length of power cord between the coupling device and the EUT was less than 2 meters (provided by the manufacturer).

4.5.2 The EUT was connected to the power mains through a coupling device that directly couples the Surge interference signal. The surge noise was applied synchronized to the voltage phase at the zero crossing and the peak value of the AC voltage wave (positive and negative).

4.5.3 The surges were applied line to line and line(s) to earth. When testing line to earth the test voltage was applied successively between each of the lines and earth. Steps up to the test level specified increased the test voltage. All lower levels including the selected test level were tested. The polarity of each surge level included positive and negative test pulses.

## 4.6 Test Result

### PASS.

4.6.1 The performance criterion after tested IEC 61000-4-5 (EN 55024):

- Input DC power ports:  $\pm 0.5\text{kV}$ (peak): Line to line  
Performance criterion:  **A**     **B**     **C**
- Input DC power ports:  $\pm 1.0\text{kV}$ (peak): Line to line  
Performance criterion:  **A**     **B**     **C**

4.6.2 The performance criterion after tested IEC 61000-4-5 (EN 61204-3):

- Input DC power ports:  $\pm 0.5\text{kV}$ (peak): Line to line  
Performance criterion:  **A**     **B**     **C**
- Input DC power ports:  $\pm 1.0\text{kV}$ (peak): Line to line  
Performance criterion:  **A**     **B**     **C**

4.6.3 The performance criterion after tested IEC 61000-4-5 (EN 61000-6-1):

- Input DC power ports:  $\pm 0.5\text{kV}$ (peak): Line to line  
Performance criterion:  **A**     **B**     **C**
- Input DC power ports:  $\pm 1.0\text{kV}$ (peak): Line to line  
Performance criterion:  **A**     **B**     **C**

# Test Report



(Declaration of Conformity)

for

Electromagnetic Compatibility

of

**E.U.T.: Switching Power Supply**

Trade Name: MEAN WELL

Model Number: NSD10-xyz

(x=12 or 48, y=S or D, z=3, 5, 9, 12, 15)

Prepared for

**MEAN WELL ENTERPRISES CO., LTD.**

No. 28, Wu-Chuan 3<sup>rd</sup> Road, Wu Ku Ind. Park,

Taipei Hsien, Taiwan

TEL: +886 2 2299-6100

FAX: +886 2 2299-6200

Prepared by

**Interocean EMC Technology Corp.**

244 No.5-2, Lin 1, Tin-Fu Tsun, Lin-Kou Hsiang,

Taipei County, Taiwan 244, R.O.C.

TEL.: +886 2 2600 6861

FAX.: +886 2 2600 6859

**Remark:**

The test report consists of **127** pages in total. It shall not be reproduced except in full, without the written approval of IETC. This document may be altered or revised by IETC only, and shall be noted in the revision section of the document. The test results in the report only to the tested sample.



# Table of Contents

<b>1</b>	<b>General Information</b>	<b>6</b>
1.1	Description of Equipment Under Test	6
1.2	Specifications Description of Output Voltage / Current:	7
1.3	Details of tested supporting System	8
1.4	Test Facility	9
1.5	Measurement Uncertainty	10
1.6	Measured Mode	11
1.7	Configuration of EUT Setup	12
1.8	Test Step of EUT	12
<b>2</b>	<b>Power Line Conducted Emission Measurement</b>	<b>13</b>
<b>3</b>	<b>Radiated Emission Measurement</b>	<b>14</b>
3.1	Instrument	14
3.2	Block Diagram of Test Configuration	14
3.3	Radiated Limit	15
3.4	Instrument configuration	15
3.5	Configuration of Measurement	15
3.6	Test Result	15
<b>4</b>	<b>Harmonic Current Emission Measurement (EN 61000-3-2)</b>	<b>80</b>
<b>5</b>	<b>Voltage Fluctuations and Flicker Measurement (EN 61000-3-3)</b>	<b>81</b>
<b>6</b>	<b>Electrostatic Discharge Immunity Test (IEC 61000-4-2)</b>	<b>82</b>
6.1	Instrument	82
6.2	Block Diagram of Test Configuration	82
6.3	Test Levels & Performance Criterion	83
6.4	Test Requirement	84
6.5	Configuration of Measurement	85
6.6	Test Result	86
<b>7</b>	<b>Radio-Frequency, Electromagnetic Field Immunity Test (IEC 61000-4-3)</b>	<b>87</b>
7.1	Instrument	87
7.2	Block Diagram of Test Configuration	87
7.3	Test Levels & Performance Criterion	88
7.4	Test Requirement	88
7.5	Configuration of Measurement	89
7.6	Test Result	89

<b>8</b>	<b>Electrical Fast Transient/Burst Immunity Test (IEC 61000-4-4)</b>	<b>90</b>
8.1	Instrument	90
8.2	Block Diagram of Test Configuration	90
8.3	Test Levels & Performance Criterion	90
8.4	Test Requirement	91
8.5	Configuration of Measurement	91
8.6	Test Result	91
<b>9</b>	<b>Surge Immunity Test (IEC 61000-4-5)</b>	<b>92</b>
9.1	Instrument	92
9.2	Block Diagram of Test Configuration	92
9.3	Test Levels & Performance Criterion	93
9.4	Test Requirement	94
9.5	Configuration of Measurement	94
9.6	Test Result	95
<b>10</b>	<b>Radio-Frequency, Conducted Disturbances Immunity Test (IEC 61000-4-6)</b>	<b>96</b>
10.1	Instrument	96
10.2	Block Diagram of Test Configuration	96
10.3	Test Levels & Performance Criterion	97
10.4	Test Requirement	97
10.5	Configuration of Measurement	98
10.6	Test Result	99
<b>11</b>	<b>Power Frequency Magnetic Field Immunity Test (IEC 61000-4-8)</b>	<b>100</b>
11.1	Instrument	100
11.2	Block Diagram of Test Configuration	100
11.3	Test Levels & Performance Criterion	101
11.4	Test Requirement	101
11.5	Configuration of Measurement	101
11.6	Test Result	102
<b>12</b>	<b>Voltage Dips, Short Interruptions Immunity Test (IEC 61000-4-11)</b>	<b>103</b>
<b>13</b>	<b>Photographs of Test</b>	<b>104</b>
13.1	Radiated Emission Measurement	104
13.2	Electrostatic Discharge Immunity Test (IEC 61000-4-2)	106
13.3	Radio-Frequency, Electromagnetic Field Immunity Test (IEC 61000-4-3)	107
13.4	Electrical Fast Transient/Burst Immunity Test (IEC 61000-4-4)	108
13.5	Surge Immunity Test (IEC 61000-4-5)	108
13.6	Radio-Frequency, Conducted Disturbances Immunity Test (IEC 61000-4-6)	109
13.7	Power Frequency Magnetic Field Immunity Test (IEC 61000-4-8)	109

<b>14</b>	<b>Photographs of EUT</b>	<b>110</b>
14.1	(Model No.: NSD10-12D5)	110
14.2	(Model No.: NSD10-12D12)	111
14.3	(Model No.: NSD10-12D15)	112
14.4	(Model No.: NSD10-48D5)	113
14.5	(Model No.: NSD10-48D12)	114
14.6	(Model No.: NSD10-48D15)	115
14.7	(Model No.: NSD10-12S3)	116
14.8	(Model No.: NSD10-12S5)	117
14.9	(Model No.: NSD10-12S9)	118
14.10	(Model No.: NSD10-12S12)	119
14.11	(Model No.: NSD10-12S15)	120
14.12	(Model No.: NSD10-48S3)	121
14.13	(Model No.: NSD10-48S5)	122
14.14	(Model No.: NSD10-48S9)	123
14.15	(Model No.: NSD10-48S12)	124
14.16	(Model No.: NSD10-48S15)	125
<b>15</b>	<b>Photographs of PCB (For NSD10-xDz Series)</b>	<b>126</b>
<b>16</b>	<b>Photographs of PCB (For NSD10-xSz Series)</b>	<b>127</b>

## Verification of Compliance

**Applicant:** MEAN WELL ENTERPRISES CO., LTD.  
**Manufacturer:** MEAN WELL ENTERPRISES CO., LTD.  
**EUT Description:** Switching Power Supply  
**Model No.:** NSD10-xyz  
 (x=12 or 48, y=S or D, z=3, 5, 9, 12, 15)  
**Tested Power Supply:** 12Vdc / 1.4A; 48Vdc / 0.4A  
**Date of Final Test:** Jan. 31, 2007

### Measurement Procedures and Standards Used :

#### Emission:

- EN 55011: 1998+A1: 1999+A2: 2002  
 EN 55022: 1998+A1: 2000+A2: 2003  
 EN 61000-6-3: 2001+A11: 2004  
 EN 61000-3-2: 2000+A2: 2005  
 EN 61000-3-3: 1995+A1: 2001

#### Immunity:

- EN 55024: 1998+A1: 2001+A2: 2003  
 IEC 61000-4-2: 1995+A1: 1998+A2: 2000  
 IEC 61000-4-3: 2006  
 IEC 61000-4-4: 2004  
 IEC 61000-4-5: 2005  
 IEC 61000-4-6: 2003+A1: 2004+A2: 2006  
 IEC 61000-4-8: 1993+A1: 2000  
 IEC 61000-4-11: 2004  
 ENV 50204: 1995
- EN 61000-6-1: 2001  
 IEC 61000-4-2: 1995+A1: 1998+A2: 2000  
 IEC 61000-4-3: 2006  
 IEC 61000-4-4: 2004  
 IEC 61000-4-5: 2005  
 IEC 61000-4-6: 2003+A1: 2004+A2: 2006  
 IEC 61000-4-8: 1993+A1: 2000  
 IEC 61000-4-11: 2004
- EN 61204-3: 2000  
 IEC 61000-4-2: 1995+A1: 1998+A2: 2000  
 IEC 61000-4-3: 2006  
 IEC 61000-4-4: 2004  
 IEC 61000-4-5: 2005  
 IEC 61000-4-6: 2003+A1: 2004+A2: 2006  
 IEC 61000-4-11: 2004

The device described above was tested by Interocean EMC Technology Corporation to determine the maximum emission levels emanated from the device and severity levels of the device endure and its performance criterion. The measurement results are contained in this test report and Interocean EMC Technology Corp assumes full responsibility for the accuracy and completeness of these measurements. This report shows the EUT is technically compliance with the above official standards. This report applies to the above sample only and shall not be reproduced in part without written approval of Interocean EMC Technology Corporation.

Report Issued: 2007/02/13

Test Engineer: Sunny Chen  
Sunny Chen

Checked: Benson Tsai  
Benson Tsai

Approved: Mike Huang  
Mike Huang

# 1 General Information

## 1.1 Description of Equipment Under Test

- Equipment Under Test** : Switching Power Supply
- Model Number** : NSD10-xyz  
(x=12 or 48, y=S or D, z=3, 5, 9, 12, 15)
- Serial Number** : N/A
- Type of Sample Tested** : Proto-type    Pre-Production    Mass Production
- Applicant** : **MEAN WELL ENTERPRISES CO., LTD.**  
No. 28, Wu-Chuan 3<sup>rd</sup> Road, Wu Ku Ind. Park, Taipei Hsien, Taiwan
- Manufacturer** : **MEAN WELL ENTERPRISES CO., LTD.**  
No. 28, Wu-Chuan 3<sup>rd</sup> Road, Wu Ku Ind. Park, Taipei Hsien, Taiwan
- Product information** : Input: 12Vdc / 1.4A; 48Vdc / 0.4A  
Power cord: Non-shielded Detachable, 0.2m w/o core  
Output: The detail specification, please see "Specifications Description of Output Voltage / Current" as below page.
- Date of Receipt of Sample** : Jan. 23, 2007
- Date of Test** : Jan. 23~31, 2007
- Description of E.U.T.** : 1.) The EUT is Switching Power Supply.  
2.) The Model Number "NSD10-12D5; NSD10-12D12; NSD10-12D15; NSD10-48D5; NSD10-48D12; NSD10-48D15; NSD10-12S3; NSD10-12S5; NSD10-12S9; NSD10-12S12; NSD10-12S15; NSD10-48S3; NSD10-48S5; NSD10-48S9; NSD10-48S12; NSD10-48S15" are representative selected in the test and included in this report.  
3.) The difference for all models include in this report are only Model No., Output Voltage and Output Current, the rest parts are identical.

**1.2 Specifications Description of Output Voltage / Current:**

Model No.		Output	
		Voltage (Vdc)	Current (A)
NSD10-12D5	NSD10-48D5	5.00	1.00
		-5.00	1.00
NSD10-12D12	NSD10-48D12	12.00	0.42
		-12.00	0.42
NSD10-12D15	NSD10-48D15	15.00	0.33
		-15.00	0.33
NSD10-12S3	NSD10-48S3	3.30	2.50
NSD10-12S5	NSD10-48S5	5.00	2.00
NSD10-12S9	NSD10-48S9	9.00	1.10
NSD10-12S12	NSD10-48S12	12.00	0.83
NSD10-12S15	NSD10-48S15	15.00	0.67

### 1.3 Details of tested supporting System

- 1.3.1 LOAD (NSD10-12D5; NSD10-48D5)  
FULL LOAD WATT : 5W (5Vdc, 1A), 5W (-5Vdc, 1A)  
HALF LOAD WATT : 2.5W (5Vdc, 0.5A), 2.5W (-5Vdc, 0.5A)
- 1.3.2 LOAD (NSD10-12D12; NSD10-48D12)  
FULL LOAD WATT : 5.04W (12Vdc, 0.42A), 5.04W (-12Vdc, 0.42A)  
HALF LOAD WATT : 2.52W (12Vdc, 0.21A), 2.52W (-12Vdc, 0.21A)
- 1.3.3 LOAD (NSD10-12D15; NSD10-48D15)  
FULL LOAD WATT : 4.95W (15Vdc, 0.33A), 4.95W (-15Vdc, 0.33A)  
HALF LOAD WATT : 2.475W (15Vdc, 0.165A), 2.475W (-15Vdc, 0.165A)
- 1.3.4 LOAD (NSD10-12S3; NSD10-48S3)  
FULL LOAD WATT : 8.25W (3.3Vdc, 2.5A)  
HALF LOAD WATT : 4.125W (3.3Vdc, 1.25A)
- 1.3.5 LOAD (NSD10-12S5; NSD10-48S5)  
FULL LOAD WATT : 10W (5Vdc, 2A)  
HALF LOAD WATT : 5W (5Vdc, 1A)
- 1.3.6 LOAD (NSD10-12S9; NSD10-48S9)  
FULL LOAD WATT : 9.9W (9Vdc, 1.1A)  
HALF LOAD WATT : 4.95W(9Vdc, 0.55A)
- 1.3.7 LOAD (NSD10-12S12; NSD10-48S12)  
FULL LOAD WATT : 9.96W (12Vdc, 0.83A)  
HALF LOAD WATT : 4.98W (12Vdc, 0.415A)
- 1.3.8 LOAD (NSD10-12S15; NSD10-48S15)  
FULL LOAD WATT : 10.05W (15Vdc, 0.67A)  
HALF LOAD WATT : 5.025W (15Vdc, 0.335A)

**1.4 Test Facility**

- Site Description** : OATS 1    OATS 2    OATS 3    OATS 4
- Name of Firm** : Interocean EMC Technology Corp.
- Company web** : <http://www.ietc.com.tw>
- Site 1, 2 Location** : No.5-2, Lin 1, Tin-Fu Tsun, Lin-Kou Hsiang, Taipei County, Taiwan, R.O.C.
- Site 3, 4 Location** : No. 12, Ruei-Shu Valley, Ruei-Ping Tsun, Lin-Kou Hsiang, Taipei County, Taiwan, R.O.C.
- Site Filing** :
  - Federal Communication Commissions – USA  
Registration No.: 96399 (OATS 1 & 2)  
Registration No.: 518958 (OATS 3 & 4)
  - Voluntary Control Council for Interference by Information Technology Equipment (VCCI) – Japan  
Registration No. (Conducted Room): C-1094  
Registration No. (Conducted Room): T-271  
Registration No. (OATS 1): R-1040  
Registration No. (OATS 2): R-1041  
Registration No. (OATS 3): R-1812  
Registration No. (OATS 4): R-1813
  - Industry Canada (IC)  
Submission: 113543
  - Japan Electrical Safety & Environment Technology Laboratories (JET)  
Registration No.:04S03-01
- Site Accreditation** :
  - Bureau of Standards and Metrology and Inspection (BSMI) – Taiwan, R.O.C.  
Accreditation No.:  
SL2-IN-E-0026 for CNS13438 / CISPR22  
SL2-R1-E-0026 for CNS13439 / CISPR13  
SL2-R2-E-0026 for CNS13439 / CISPR13  
SL2-A1-E-0026 for CNS13783-1 / CISPR14-1
  - National Voluntary Laboratory Accreditation Program (NVLAP) - USA  
Lab Code: 200458-0
  - Nemko AS  
Authorization No.: ELA 181A  
Authorization No.: ELA 181B
  - Taiwan Accreditation Foundation (TAF)  
Accrditation No.: 1113
  - TÜV Rheinland  
Certificate No: 10006453

**1.4.1 Test Methodology**

Both conducted and Radiated Emission Measurement were performed according to the procedures in EN 55011:1998+A1: 1999 +A2: 2002, EN 55022: 1998 +A1:2000+A2: 2003, EN 61000-6-3: 2001+A11: 2004. Radiated Emission Measurement was performed at 10 meters distance from antenna to EUT. All immunity tests were performed according to the procedures in EN 55024:1998+A1: 2001+A2: 2003, EN 61204-3: 2000 and EN 61000-6-1: 2001.





## 1.5 Measurement Uncertainty

No.	Item	Value
1	Power Line Conducted Emission (Conduction 1)	2.52dB
2	Power Line Conducted Emission (Conduction 2)	2.52dB
3	Power Line Conducted Emission (Conduction 3)	2.52dB
4	Power Line Conducted Emission (Conduction 4)	2.52dB
5	Radiated Emission Test (OATS 1)	3.14 dB
6	Radiated Emission Test (OATS 2)	3.14 dB
7	Radiated Emission Test (OATS 3)	3.14 dB
8	Radiated Emission Test (OATS 4)	3.14 dB
9	Radio-frequency, Electromagnetic field Immunity Test (RS)	1.47 dB
10	Radio-frequency, Conducted Disturbances Immunity Test (CS)	2.35 dB

## 1.6 Measured Mode

1.6.1 The test modes for preliminary test are as following:

- **Mode 1: FULL LOAD (NSD10-12D5)**
- Mode 2: HALF LOAD (NSD10-12D5)
- Mode 3: FULL LOAD (NSD10-12D12)
- Mode 4: HALF LOAD (NSD10-12D12)
- Mode 5: FULL LOAD (NSD10-12D15)
- Mode 6: HALF LOAD (NSD10-12D15)
  
- Mode 7: FULL LOAD (NSD10-48D5)
- Mode 8: HALF LOAD (NSD10-48D5)
- Mode 9: FULL LOAD (NSD10-48D12)
- Mode 10: HALF LOAD (NSD10-48D12)
- Mode 11: FULL LOAD (NSD10-48D15)
- Mode 12: HALF LOAD (NSD10-48D15)
  
- Mode 13: FULL LOAD (NSD10-12S3)
- Mode 14: HALF LOAD (NSD10-12S3)
- **Mode 15: FULL LOAD (NSD10-12S5)**
- Mode 16: HALF LOAD (NSD10-12S5)
- Mode 17: FULL LOAD (NSD10-12S9)
- Mode 18: HALF LOAD (NSD10-12S9)
- Mode 19: FULL LOAD (NSD10-12S12)
- Mode 20: HALF LOAD (NSD10-12S12)
- Mode 21: FULL LOAD (NSD10-12S15)
- Mode 22: HALF LOAD (NSD10-12S15)
  
- Mode 23: FULL LOAD (NSD10-48S3)
- Mode 24: HALF LOAD (NSD10-48S3)
- Mode 25: FULL LOAD (NSD10-48S5)
- Mode 26: HALF LOAD (NSD10-48S5)
- Mode 27: FULL LOAD (NSD10-48S9)
- Mode 28: HALF LOAD (NSD10-48S9)
- Mode 29: FULL LOAD (NSD10-48S12)
- Mode 30: HALF LOAD (NSD10-48S12)
- Mode 31: FULL LOAD (NSD10-48S15)
- Mode 32: HALF LOAD (NSD10-48S15)

1.6.2 For conduction and radiation tests, selected the worst-case **modes 1~32** after preliminary test for final test.

1.6.3 For EN 61000-3-2, EN 61000-3-3 and immunity tests, selected the **modes 1, 15** for final test.

## 1.7 Configuration of EUT Setup

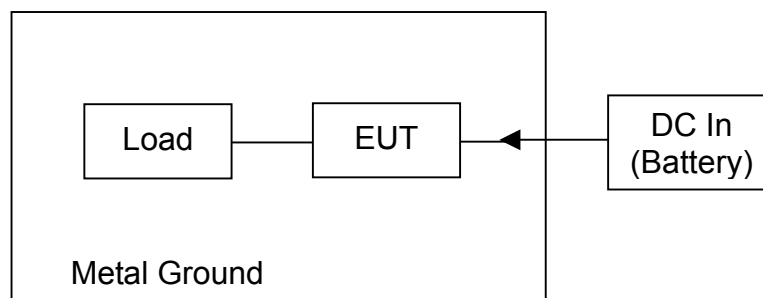

## 1.8 Test Step of EUT

- 1.8.1 Setup the EUT and peripheral as above.
- 1.8.2 Connected the EUT with load at full load mode.
- 1.8.3 Executed the test.
- 1.8.4 Changed the EUT load to half load and executed the test.

## **2 Power Line Conducted Emission Measurement**

This EUT is powered by DC to DC type, therefore it is not specified in this section.

### 3 Radiated Emission Measurement

#### 3.1 Instrument

☒ OATS 1

Instrument	Manufacturer	Model	Serial No.	Last Calibration
EMI Test Receiver	Rohde & Schwarz	ES17	830154/002	2006/08/09
Bilog Antenna	Schaffner	CBL6111c	2804	2006/03/03
Pre-Amplifier	Schaffner	CPA9231A	3351	2006/12/14
RF Cable	Ultra Link	CBL17	CBL17	2006/02/24

Note: All instrument upon which need to be calibrated are within calibration period of 1 year.

#### 3.2 Block Diagram of Test Configuration

Configuration of Instrument Setup.

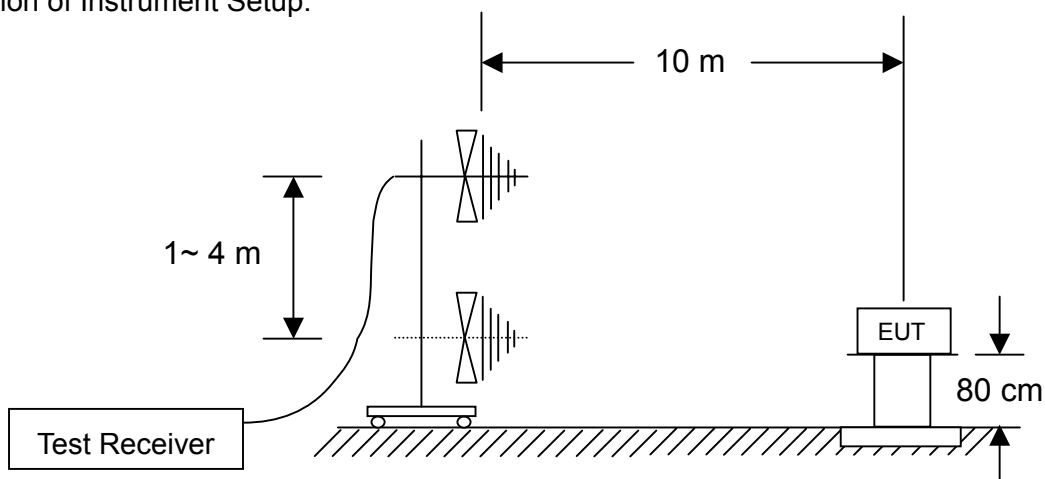

### 3.3 Radiated Limit

EN 55011 / EN 55022 / EN 61000-6-3

Frequency (MHz)	<input type="checkbox"/> Class A	<input checked="" type="checkbox"/> Class B
	Quasi-Peak dB( $\mu$ V/m)	Quasi-Peak dB( $\mu$ V/m)
30 ~ 230	40.0	30.0
230 ~ 1000	47.0	37.0

### 3.4 Instrument configuration

- 3.4.1 Set the EMI test receiver frequency range from 30 MHz to 1000 MHz.
- 3.4.2 Set the EMI test receiver bandwidth at 120 kHz.
- 3.4.3 Set the EMI test receiver detector as Quasi-Peak (Q.P.).

### 3.5 Configuration of Measurement

- 3.5.1 The EUT was placed on a non-conductive table whose total height equaled 80cm. The turntable can rotate 360 degree to determine the position of the maximum emission level.
- 3.5.2 The EUT was set 10 meters away from the receiving antenna that was mounted on a non-conductive mast. The antenna can move up and down between 1 to 4 meters to find out the maximum emission level.
- 3.5.3 The initial testing identified the frequency that has the highest disturbance relative to the limit while operating the EUT in typical modes of operation and cable positions in a test setup representative of typical system configuration.
- 3.5.4 The identification of the frequency of highest emission with respect to the limit was found by investigating emissions at a number of significant frequencies. The probable frequency of maximum emission had been found and that the associated cable and EUT configuration and mode of operation had been identified.

### 3.6 Test Result

**PASS.**

The final test data is shown on as following pages.

### Radiated Emission Measurement Data

EUT: Switching Power Supply CLIENT: MEAN WELL MODEL: NSD10-12D5 RATING: DC 12V Temperature: 14.0 °C Humidity: 57 %	POLARITY: Horizontal DISTANCE: 10 m Serial No.: FILE/DATA#: MEAN WELL.emi/86 OPERATOR: VICTOR TEST SITE: OATS1
---	---

Frequency	Factor	Meter Reading	Emission Level	Limits	Margin
(MHz)	(dB)	(dBμV)	(dBμV/m)	(dBμV/m)	(dB)
60.727 **	-19.94	37.01	17.07	30.00	-12.93
73.292 **	-21.48	39.76	18.28	30.00	-11.72
85.629 **	-19.49	40.88	21.39	30.00	-8.61
109.659 **	-15.81	36.98	21.17	30.00	-8.83
121.090 **	-14.80	33.81	19.01	30.00	-10.99
206.613 **	-10.40	31.36	20.96	30.00	-9.04

Remark:

1. “\*” Mark means readings are Peak Values.
2. “\*\*” Mark means readings are Quasi-Peak values.
3. Factor = Antenna Factor + Cable Loss – Pre-amplifier.

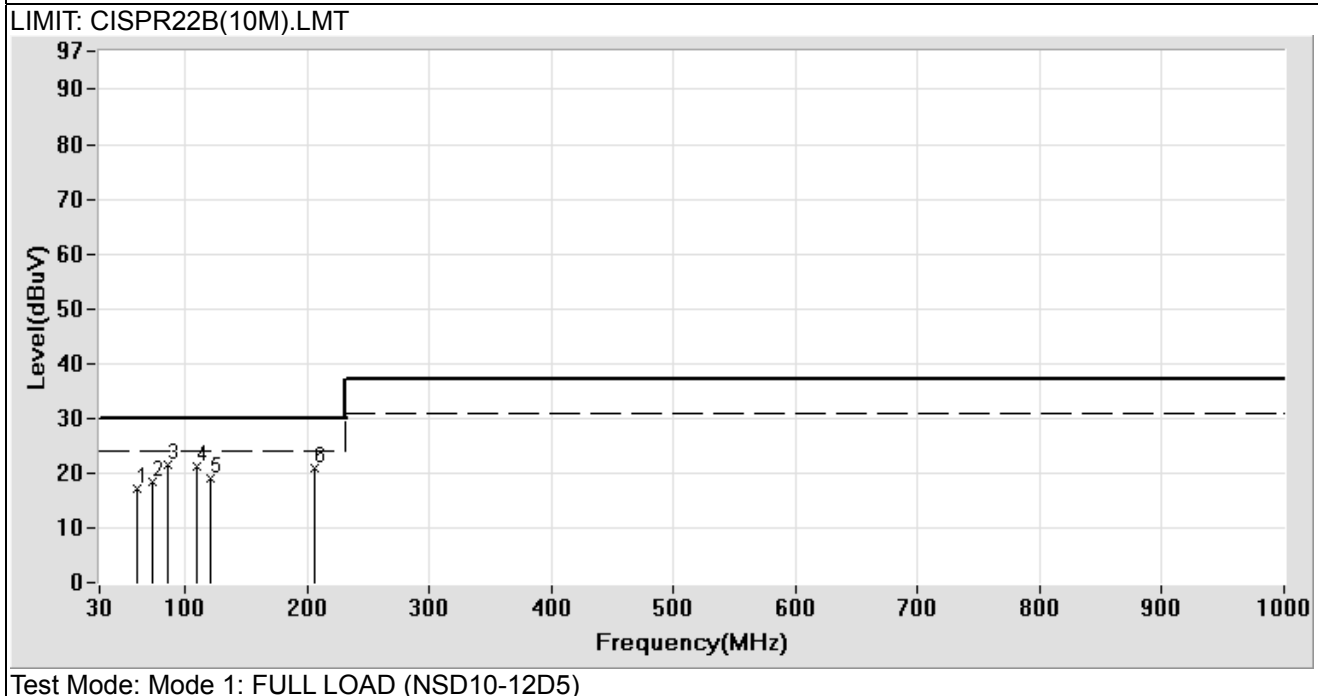

### Radiated Emission Measurement Data

EUT: Switching Power Supply CLIENT: MEAN WELL MODEL: NSD10-12D5 RATING: DC 12V Temperature: 14.0 °C Humidity: 57 %	POLARITY: Vertical DISTANCE: 10 m Serial No.: FILE/DATA#: MEAN WELL.emi/84 OPERATOR: VICTOR TEST SITE: OATS1
---	---

Frequency	Factor	Meter Reading	Emission Level	Limits	Margin
(MHz)	(dB)	(dBμV)	(dBμV/m)	(dBμV/m)	(dB)
60.384 **	-19.84	42.45	22.61	30.00	-7.39
67.010 **	-21.53	43.95	22.42	30.00	-7.58
85.857 **	-19.46	38.96	19.50	30.00	-10.50
110.028 **	-15.76	36.61	20.85	30.00	-9.15
123.118 **	-14.50	32.51	18.01	30.00	-11.99
206.813 **	-10.39	31.66	21.27	30.00	-8.73

**Remark:**

1. “ \* ” Mark means readings are Peak Values.
2. “ \*\* ” Mark means readings are Quasi-Peak values.
3. Factor = Antenna Factor + Cable Loss – Pre-amplifier.

LIMIT: CISPR22B(10M).LMT

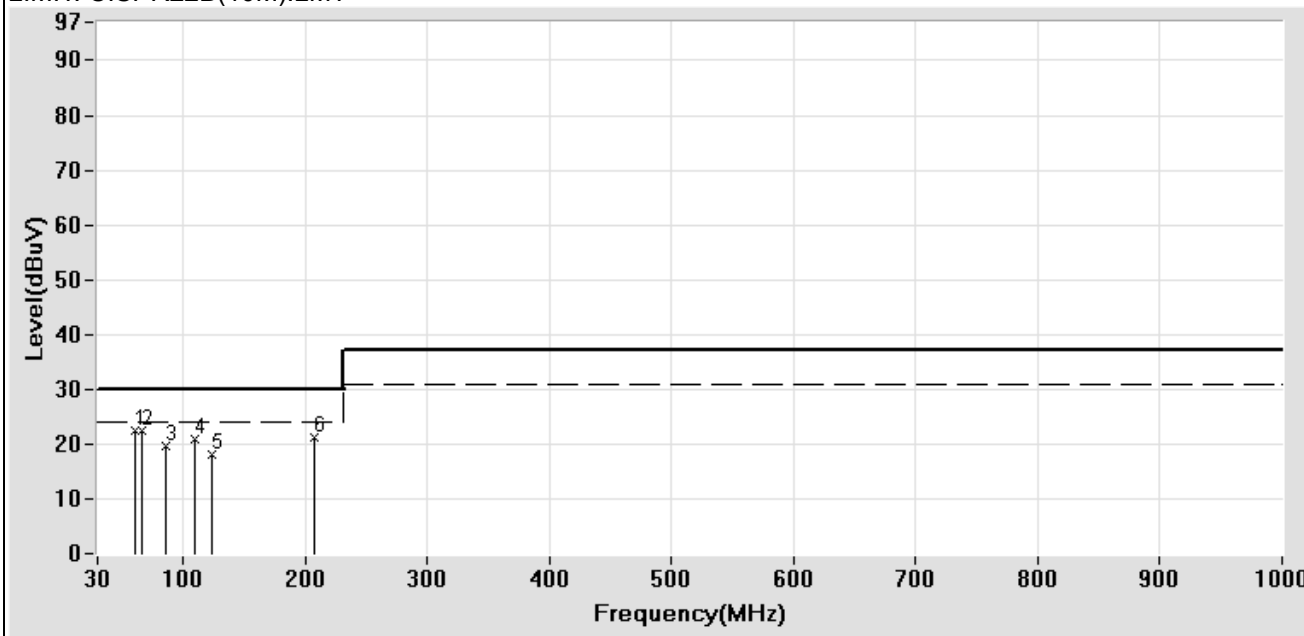

Test Mode: Mode 1: FULL LOAD (NSD10-12D5)



## Radiated Emission Measurement Data

EUT: Switching Power Supply CLIENT: MEAN WELL MODEL: NSD10-12D5 RATING: DC 12V Temperature: 18.0 °C Humidity: 79 %	POLARITY: Horizontal DISTANCE: 10 m Serial No.: FILE/DATA#: MEAN WELL.emi/283 OPERATOR: Nigel TEST SITE: OATS1
---	---

Frequency	Factor	Meter Reading	Emission Level	Limits	Margin
(MHz)	(dB)	(dBμV)	(dBμV/m)	(dBμV/m)	(dB)
57.757 **	-19.42	39.05	19.63	30.00	-10.37
70.551 **	-22.18	40.56	18.38	30.00	-11.62
85.172 **	-19.93	38.28	18.35	30.00	-11.65
114.541 **	-15.78	34.82	19.04	30.00	-10.96
170.717 **	-11.77	30.66	18.89	30.00	-11.11
205.346 **	-10.88	30.74	19.86	30.00	-10.14

**Remark:**

1. “\*” Mark means readings are Peak Values.
2. “\*\*” Mark means readings are Quasi-Peak values.
3. Factor = Antenna Factor + Cable Loss – Pre-amplifier.

LIMIT: CISPR22B(10M).LMT

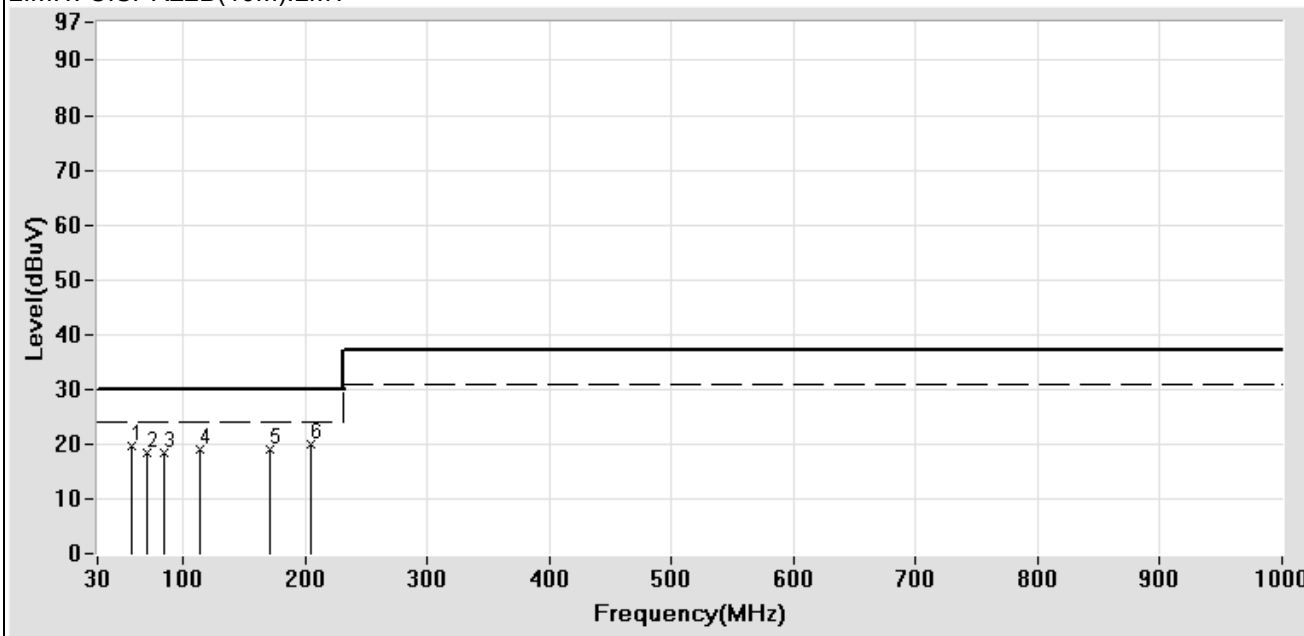

Test Mode: Mode 2: HALF LOAD (NSD10-12D5)

### Radiated Emission Measurement Data

EUT: Switching Power Supply CLIENT: MEAN WELL MODEL: NSD10-12D5 RATING: DC 12V Temperature: 18.0 °C Humidity: 79 %	POLARITY: Vertical DISTANCE: 10 m Serial No.: FILE/DATA#: MEAN WELL.emi/282 OPERATOR: Nigel TEST SITE: OATS1
---	---

Frequency	Factor	Meter Reading	Emission Level	Limits	Margin
(MHz)	(dB)	(dBμV)	(dBμV/m)	(dBμV/m)	(dB)
45.028 **	-15.91	40.59	24.68	30.00	-5.32
60.841 **	-20.33	40.47	20.14	30.00	-9.86
83.915 **	-20.06	38.53	18.47	30.00	-11.53
110.693 **	-16.09	35.19	19.10	30.00	-10.90
195.727 **	-11.02	31.55	20.53	30.00	-9.47
215.735 **	-10.57	30.58	20.01	30.00	-9.99

**Remark:**

1. “\*” Mark means readings are Peak Values.
2. “\*\*” Mark means readings are Quasi-Peak values.
3. Factor = Antenna Factor + Cable Loss – Pre-amplifier.

LIMIT: CISPR22B(10M).LMT

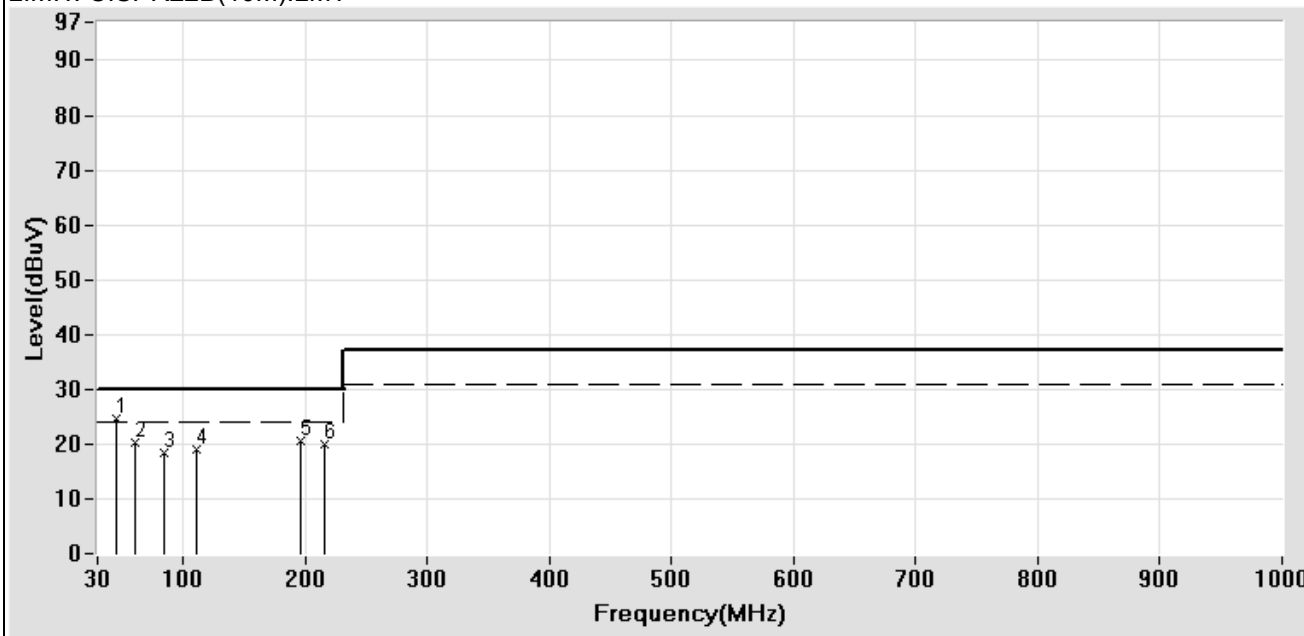

Test Mode: Mode 2: HALF LOAD (NSD10-12D5)

### Radiated Emission Measurement Data

EUT: Switching Power Supply CLIENT: MEAN WELL MODEL: NSD10-12D12 RATING: DC 12V Temperature: 14.0 °C Humidity: 57 %	POLARITY: Horizontal DISTANCE: 10 m Serial No.: FILE/DATA#: MEAN WELL.emi/103 OPERATOR: Nigel TEST SITE: OATS1
--	---

Frequency	Factor	Meter Reading	Emission Level	Limits	Margin
(MHz)	(dB)	(dBμV)	(dBμV/m)	(dBμV/m)	(dB)
58.328 **	-19.25	37.89	18.64	30.00	-11.36
72.150 **	-21.61	41.25	19.64	30.00	-10.36
84.601 **	-19.60	40.25	20.65	30.00	-9.35
114.268 **	-15.42	34.58	19.16	30.00	-10.84
160.729 **	-11.64	30.65	19.01	30.00	-10.99
206.813 **	-10.39	30.91	20.52	30.00	-9.48

**Remark:**

1. “\*” Mark means readings are Peak Values.
2. “\*\*” Mark means readings are Quasi-Peak values.
3. Factor = Antenna Factor + Cable Loss – Pre-amplifier.

LIMIT: CISPR22B(10M).LMT

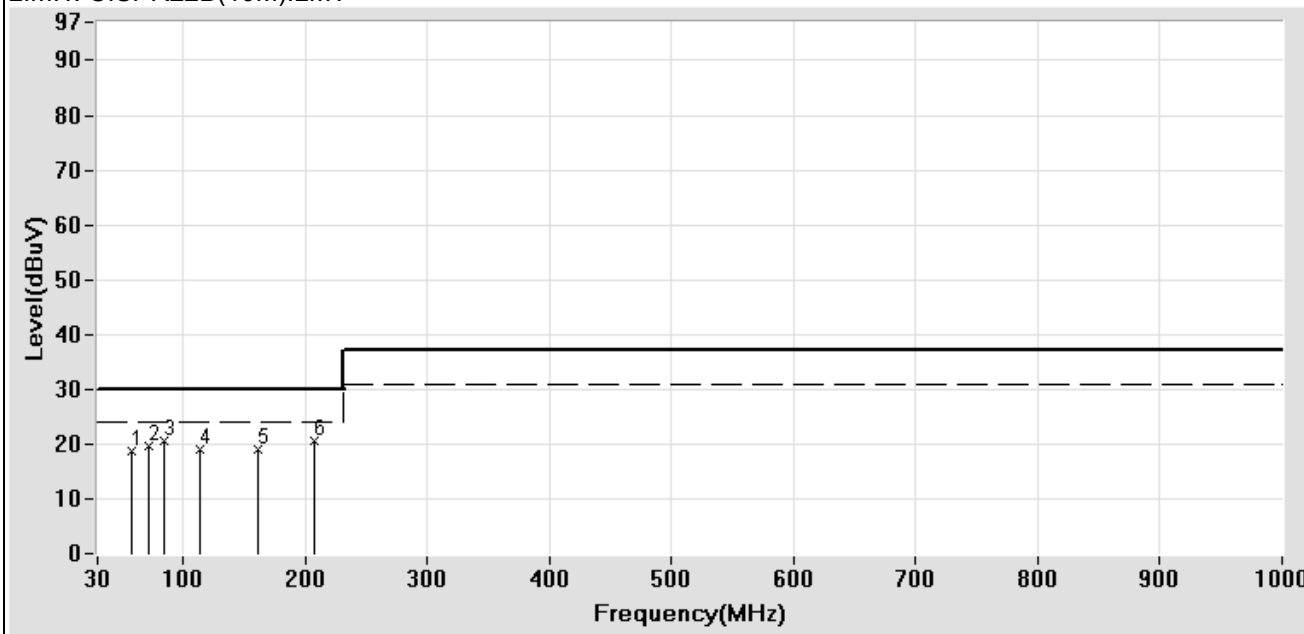

Test Mode: Mode 3: FULL LOAD (NSD10-12D12)

### Radiated Emission Measurement Data

EUT: Switching Power Supply CLIENT: MEAN WELL MODEL: NSD10-12D12 RATING: DC 12V Temperature: 14.0 °C Humidity: 57 %	POLARITY: Vertical DISTANCE: 10 m Serial No.: FILE/DATA#: MEAN WELL.emi/104 OPERATOR: Nigel TEST SITE: OATS1
--	---

Frequency	Factor	Meter Reading	Emission Level	Limits	Margin
(MHz)	(dB)	(dBμV)	(dBμV/m)	(dBμV/m)	(dB)
50.332 **	-17.05	39.87	22.82	30.00	-7.18
61.641 **	-20.24	41.25	21.01	30.00	-8.99
84.258 **	-19.64	41.25	21.61	30.00	-8.39
112.609 **	-15.55	35.08	19.53	30.00	-10.47
161.651 **	-11.61	30.83	19.22	30.00	-10.78
206.412 **	-10.40	31.37	20.97	30.00	-9.03

**Remark:**

1. “\*” Mark means readings are Peak Values.
2. “\*\*” Mark means readings are Quasi-Peak values.
3. Factor = Antenna Factor + Cable Loss – Pre-amplifier.

LIMIT: CISPR22B(10M).LMT

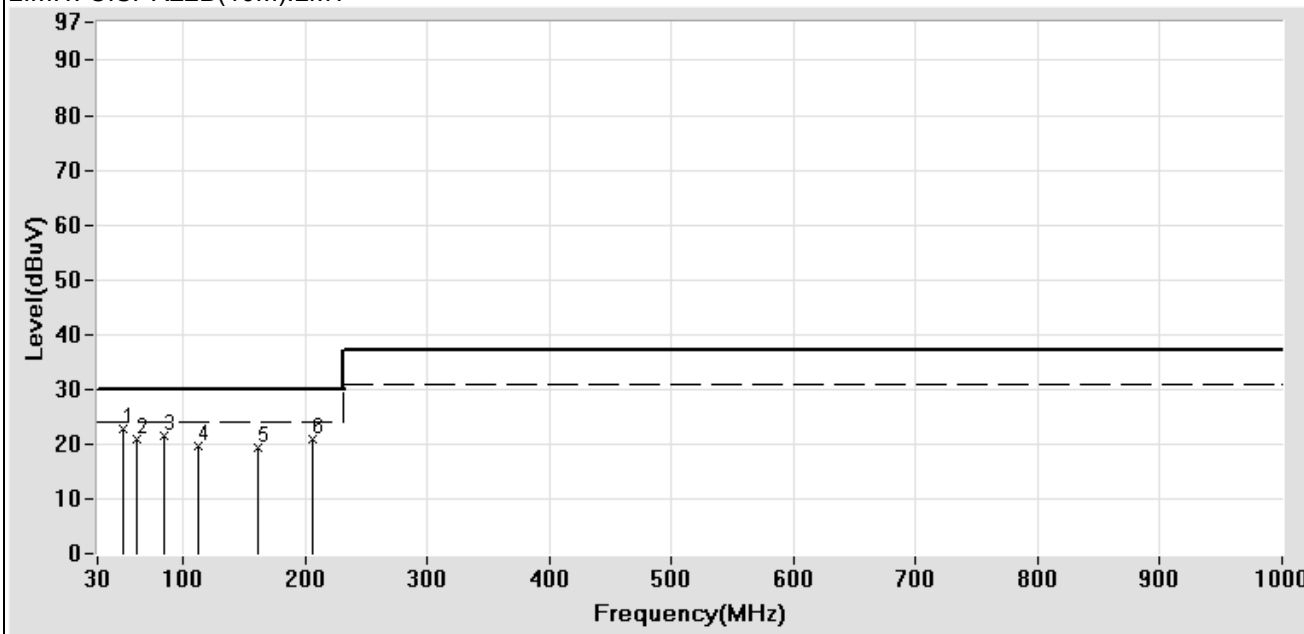

Test Mode: Mode 3: FULL LOAD (NSD10-12D12)

### Radiated Emission Measurement Data

EUT: Switching Power Supply CLIENT: MEAN WELL MODEL: NSD10-12D12 RATING: DC 12V Temperature: 18.0 °C Humidity: 79 %	POLARITY: Horizontal DISTANCE: 10 m Serial No.: FILE/DATA#: MEAN WELL.emi/290 OPERATOR: Nigel TEST SITE: OATS1
--	---

Frequency	Factor	Meter Reading	Emission Level	Limits	Margin
(MHz)	(dB)	(dBμV)	(dBμV/m)	(dBμV/m)	(dB)
57.757 **	-19.42	40.86	21.44	30.00	-8.56
70.551 **	-22.18	42.47	20.29	30.00	-9.71
85.400 **	-19.91	39.45	19.54	30.00	-10.46
114.925 **	-15.75	33.59	17.84	30.00	-12.16
161.867 **	-12.03	32.56	20.53	30.00	-9.47
207.270 **	-10.83	30.66	19.83	30.00	-10.17

Remark:

1. “\*” Mark means readings are Peak Values.
2. “\*\*” Mark means readings are Quasi-Peak values.
3. Factor = Antenna Factor + Cable Loss – Pre-amplifier.

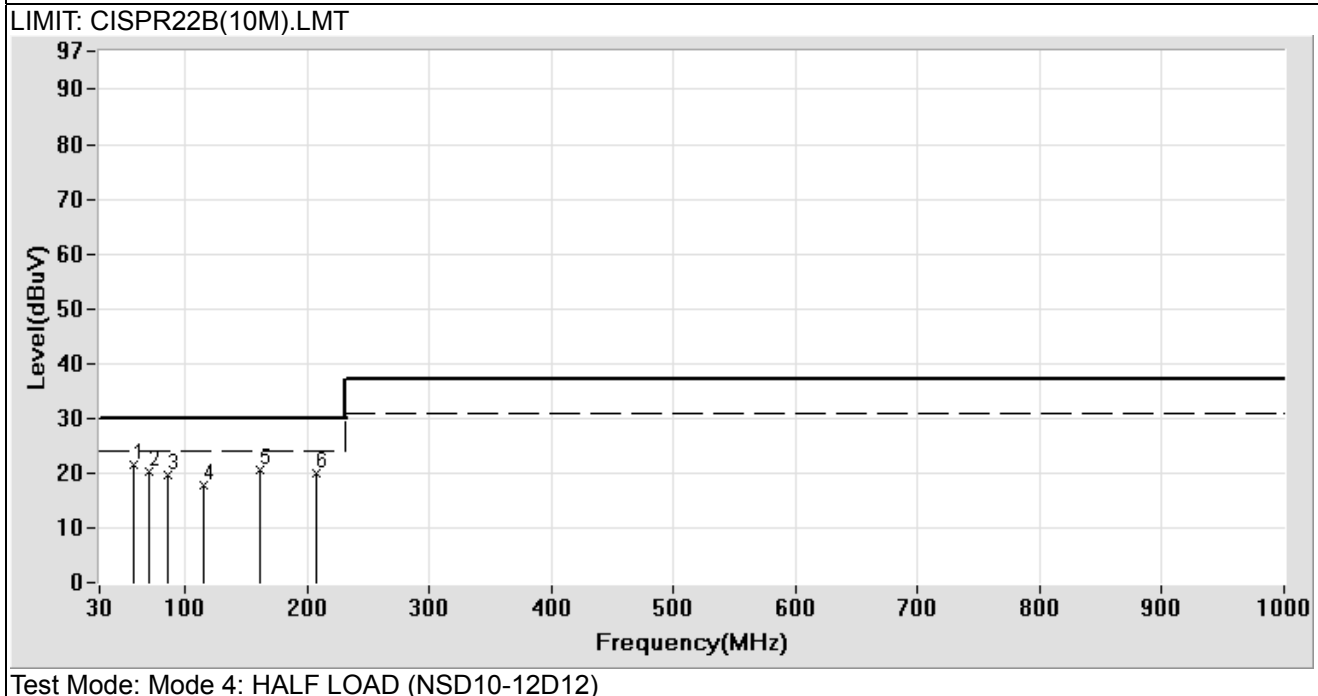

### Radiated Emission Measurement Data

EUT: Switching Power Supply	POLARITY: Vertical
CLIENT: MEAN WELL	DISTANCE: 10 m
MODEL: NSD10-12D12	Serial No.:
RATING: DC 12V	FILE/DATA#: MEAN WELL.emi/291
Temperature: 18.0 °C	OPERATOR: Nigel
Humidity: 79 %	TEST SITE: OATS1

Frequency (MHz)	Factor (dB)	Meter Reading (dBµV)	Emission Level (dBµV/m)	Limits (dBµV/m)	Margin (dB)
47.134 **	-16.49	39.56	23.07	30.00	-6.93
67.238 **	-21.93	42.95	21.02	30.00	-8.98
76.262 **	-21.34	42.56	21.22	30.00	-8.78
114.925 **	-15.75	34.35	18.60	30.00	-11.40
183.799 **	-11.17	30.56	19.39	30.00	-10.61
207.270 **	-10.83	31.41	20.58	30.00	-9.42

**Remark:**

1. “\*” Mark means readings are Peak Values.
2. “\*\*” Mark means readings are Quasi-Peak values.
3. Factor = Antenna Factor + Cable Loss – Pre-amplifier.

LIMIT: CISPR22B(10M).LMT

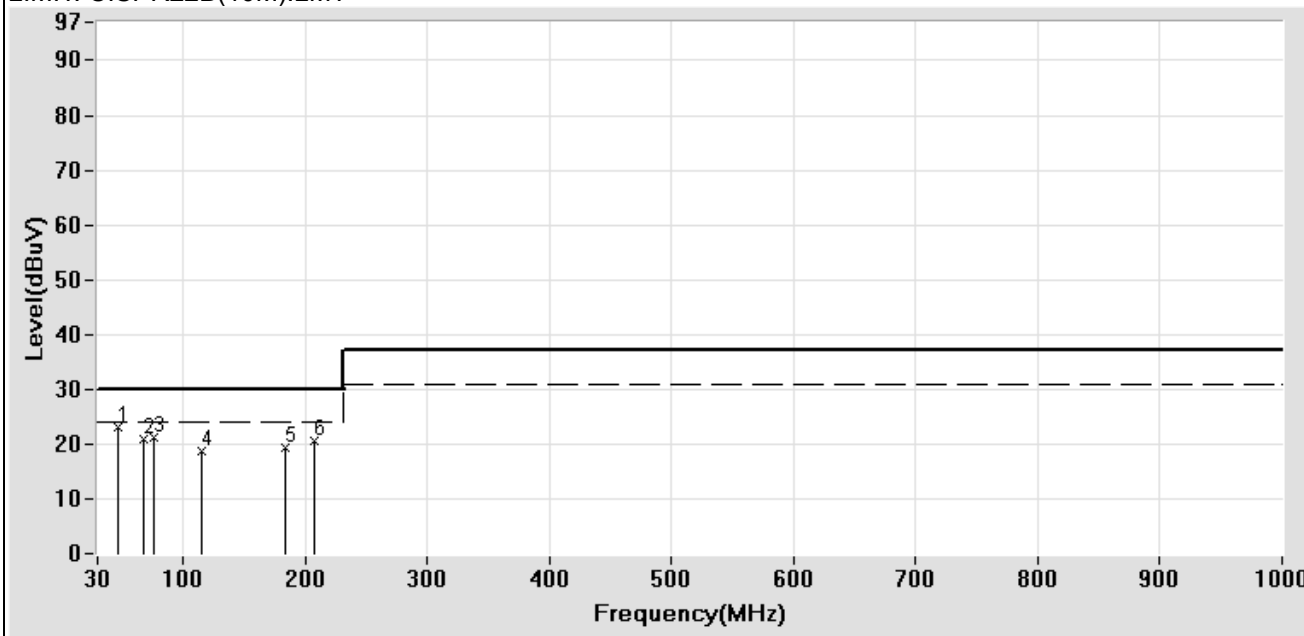

Test Mode: Mode 4: HALF LOAD (NSD10-12D12)

### Radiated Emission Measurement Data

EUT: Switching Power Supply CLIENT: MEAN WELL MODEL: NSD10-12D15 RATING: DC 12V Temperature: 14.0 °C Humidity: 57 %	POLARITY: Horizontal DISTANCE: 10 m Serial No.: FILE/DATA#: MEAN WELL.emi/106 OPERATOR: Nigel TEST SITE: OATS1
--	---

Frequency	Factor	Meter Reading	Emission Level	Limits	Margin
(MHz)	(dB)	(dBμV)	(dBμV/m)	(dBμV/m)	(dB)
56.743 **	-18.80	39.69	20.89	30.00	-9.11
66.667 **	-21.51	41.25	19.74	30.00	-10.26
84.601 **	-19.60	40.26	20.66	30.00	-9.34
110.396 **	-15.73	35.79	20.06	30.00	-9.94
120.537 **	-14.88	34.43	19.55	30.00	-10.45
207.615 **	-10.36	30.36	20.00	30.00	-10.00

**Remark:**

1. “\*” Mark means readings are Peak Values.
2. “\*\*” Mark means readings are Quasi-Peak values.
3. Factor = Antenna Factor + Cable Loss – Pre-amplifier.

LIMIT: CISPR22B(10M).LMT

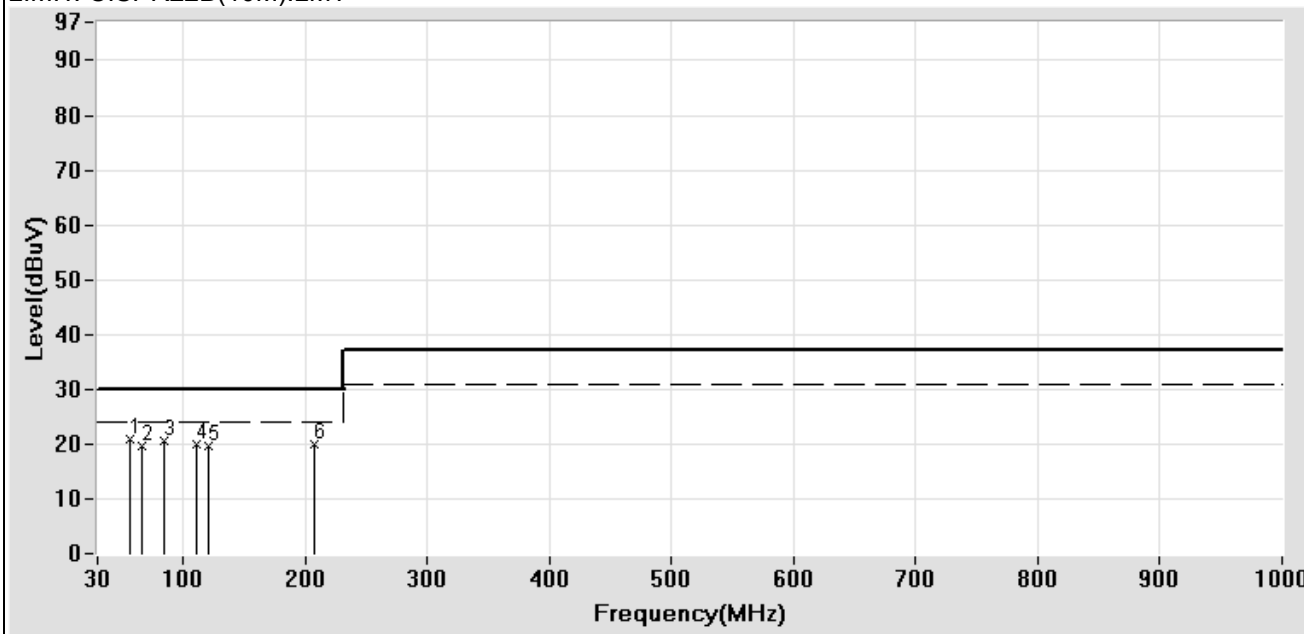

Test Mode: Mode 5: FULL LOAD (NSD10-12D15)

### Radiated Emission Measurement Data

EUT: Switching Power Supply CLIENT: MEAN WELL MODEL: NSD10-12D15 RATING: DC 12V Temperature: 14.0 °C Humidity: 57 %	POLARITY: Vertical DISTANCE: 10 m Serial No.: FILE/DATA#: MEAN WELL.emi/105 OPERATOR: Nigel TEST SITE: OATS1
--	---

Frequency	Factor	Meter Reading	Emission Level	Limits	Margin
(MHz)	(dB)	(dBμV)	(dBμV/m)	(dBμV/m)	(dB)
56.843 **	-18.83	40.87	22.04	30.00	-7.96
64.268 **	-21.08	43.12	22.04	30.00	-7.96
84.144 **	-19.66	40.58	20.92	30.00	-9.08
112.793 **	-15.54	34.78	19.24	30.00	-10.76
177.138 **	-10.98	31.26	20.28	30.00	-9.72
206.813 **	-10.39	30.63	20.24	30.00	-9.76

**Remark:**

1. “\*” Mark means readings are Peak Values.
2. “\*\*” Mark means readings are Quasi-Peak values.
3. Factor = Antenna Factor + Cable Loss – Pre-amplifier.

LIMIT: CISPR22B(10M).LMT

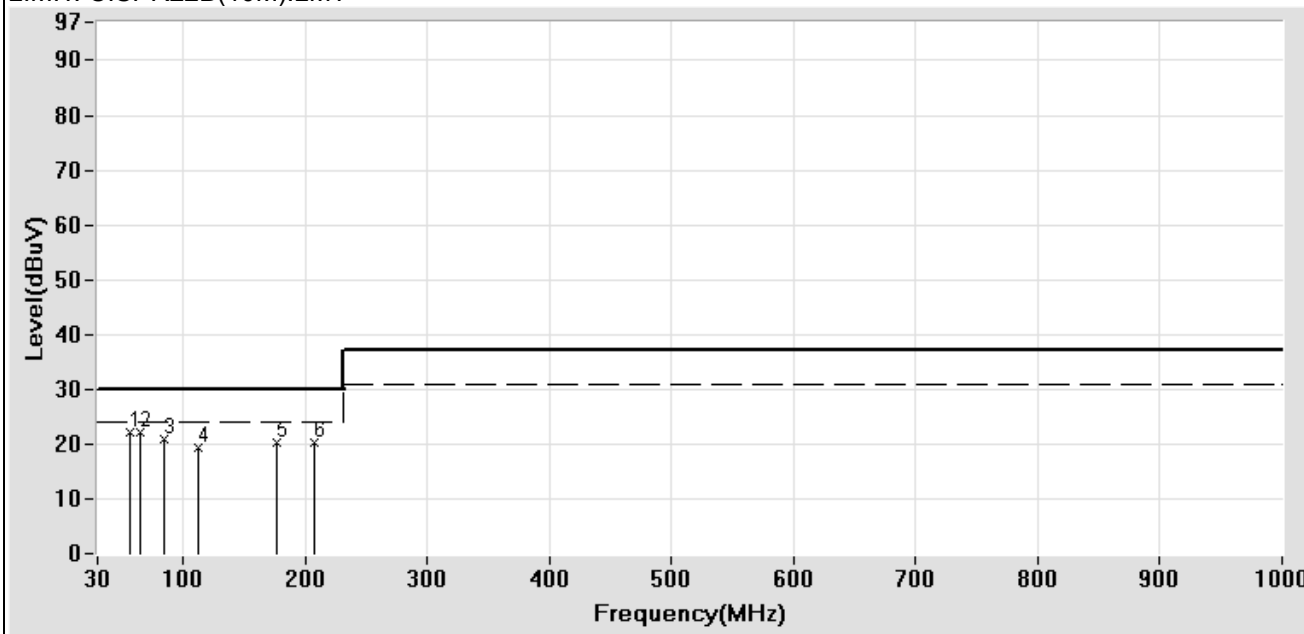

Test Mode: Mode 5: FULL LOAD (NSD10-12D15)



## Radiated Emission Measurement Data

EUT: Switching Power Supply CLIENT: MEAN WELL MODEL: NSD10-12D15 RATING: DC 12V Temperature: 18.0 °C Humidity: 79 %	POLARITY: Horizontal DISTANCE: 10 m Serial No.: FILE/DATA#: MEAN WELL.emi/285 OPERATOR: Nigel TEST SITE: OATS1
--	---

Frequency	Factor	Meter Reading	Emission Level	Limits	Margin
(MHz)	(dB)	(dBμV)	(dBμV/m)	(dBμV/m)	(dB)
58.100 **	-19.52	37.56	18.04	30.00	-11.96
70.551 **	-22.18	41.98	19.80	30.00	-10.20
84.943 **	-19.96	38.02	18.06	30.00	-11.94
119.543 **	-15.37	32.86	17.49	30.00	-12.51
171.102 **	-11.74	30.83	19.09	30.00	-10.91
206.501 **	-10.85	30.43	19.58	30.00	-10.42

**Remark:**

1. “\*” Mark means readings are Peak Values.
2. “\*\*” Mark means readings are Quasi-Peak values.
3. Factor = Antenna Factor + Cable Loss – Pre-amplifier.

LIMIT: CISPR22B(10M).LMT

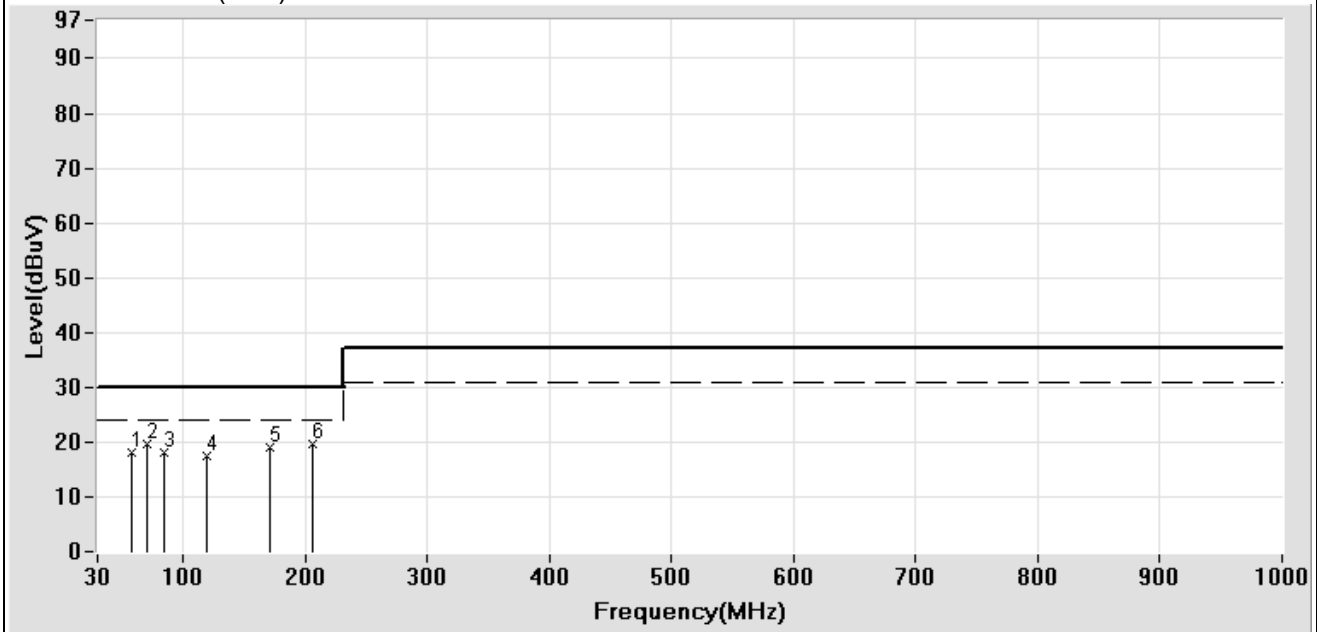

Test Mode: Mode 6: HALF LOAD (NSD10-12D15)

### Radiated Emission Measurement Data

EUT: Switching Power Supply	POLARITY: Vertical
CLIENT: MEAN WELL	DISTANCE: 10 m
MODEL: NSD10-12D15	Serial No.:
RATING: DC 12V	FILE/DATA#: MEAN WELL.emi/284
Temperature: 18.0 °C	OPERATOR: Nigel
Humidity: 79 %	TEST SITE: OATS1

Frequency (MHz)	Factor (dB)	Meter Reading (dBµV)	Emission Level (dBµV/m)	Limits (dBµV/m)	Margin (dB)
43.935 **	-15.54	39.07	23.53	30.00	-6.47
60.498 **	-20.21	40.99	20.78	30.00	-9.22
84.829 **	-19.97	39.56	19.59	30.00	-10.41
116.080 **	-15.65	35.18	19.53	30.00	-10.47
188.032 **	-11.07	32.36	21.29	30.00	-8.71
208.424 **	-10.80	30.69	19.89	30.00	-10.11

**Remark:**

1. “ \* ” Mark means readings are Peak Values.
2. “ \*\* ” Mark means readings are Quasi-Peak values.
3. Factor = Antenna Factor + Cable Loss – Pre-amplifier.

LIMIT: CISPR22B(10M).LMT

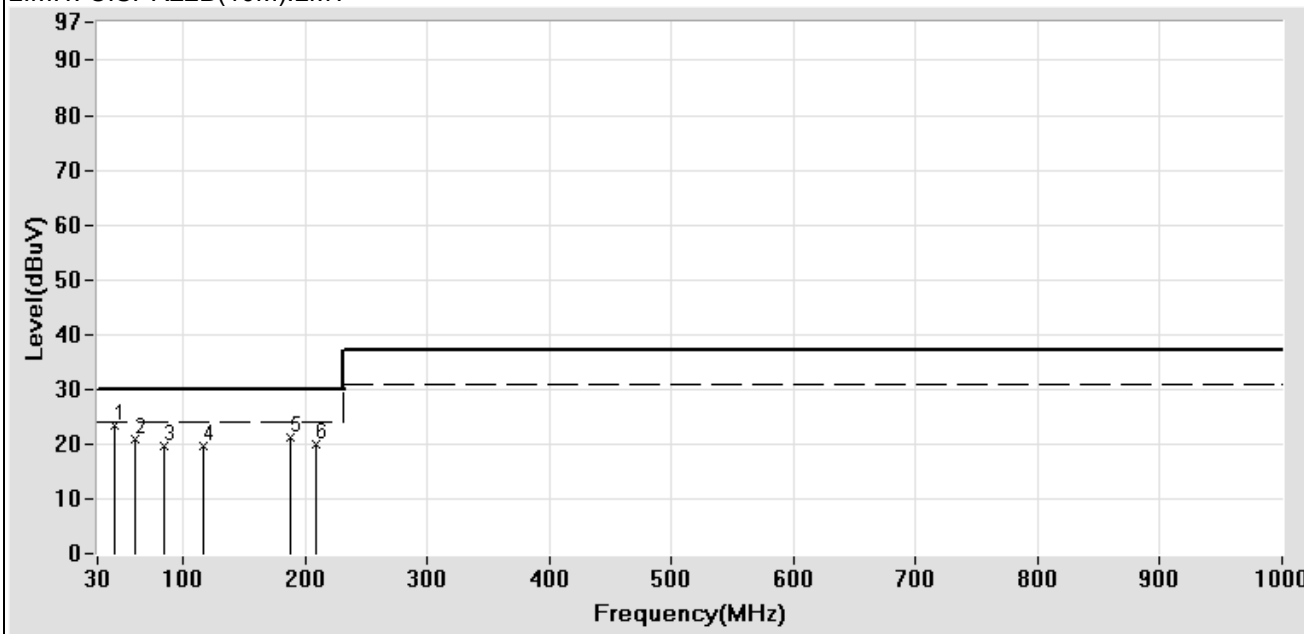

Test Mode: Mode 6: HALF LOAD (NSD10-12D15)

### Radiated Emission Measurement Data

EUT: Switching Power Supply CLIENT: MEAN WELL MODEL: NSD10-48D5 RATING: DC 48V Temperature: 14.0 °C Humidity: 57 %	POLARITY: Horizontal DISTANCE: 10 m Serial No.: FILE/DATA#: MEAN WELL.emi/124 OPERATOR: Nigel TEST SITE: OATS1
---	---

Frequency	Factor	Meter Reading	Emission Level	Limits	Margin
(MHz)	(dB)	(dBμV)	(dBμV/m)	(dBμV/m)	(dB)
56.050 **	-18.60	42.26	23.66	30.00	-6.34
63.697 **	-20.90	44.73	23.83	30.00	-6.17
119.246 **	-15.02	33.62	18.60	30.00	-11.40
156.120 **	-11.90	31.20	19.30	30.00	-10.70
207.214 **	-10.37	30.61	20.24	30.00	-9.76
225.450 **	-9.86	32.10	22.24	30.00	-7.76

**Remark:**

1. “ \* ” Mark means readings are Peak Values.
2. “ \*\* ” Mark means readings are Quasi-Peak values.
3. Factor = Antenna Factor + Cable Loss – Pre-amplifier.

LIMIT: CISPR22B(10M).LMT

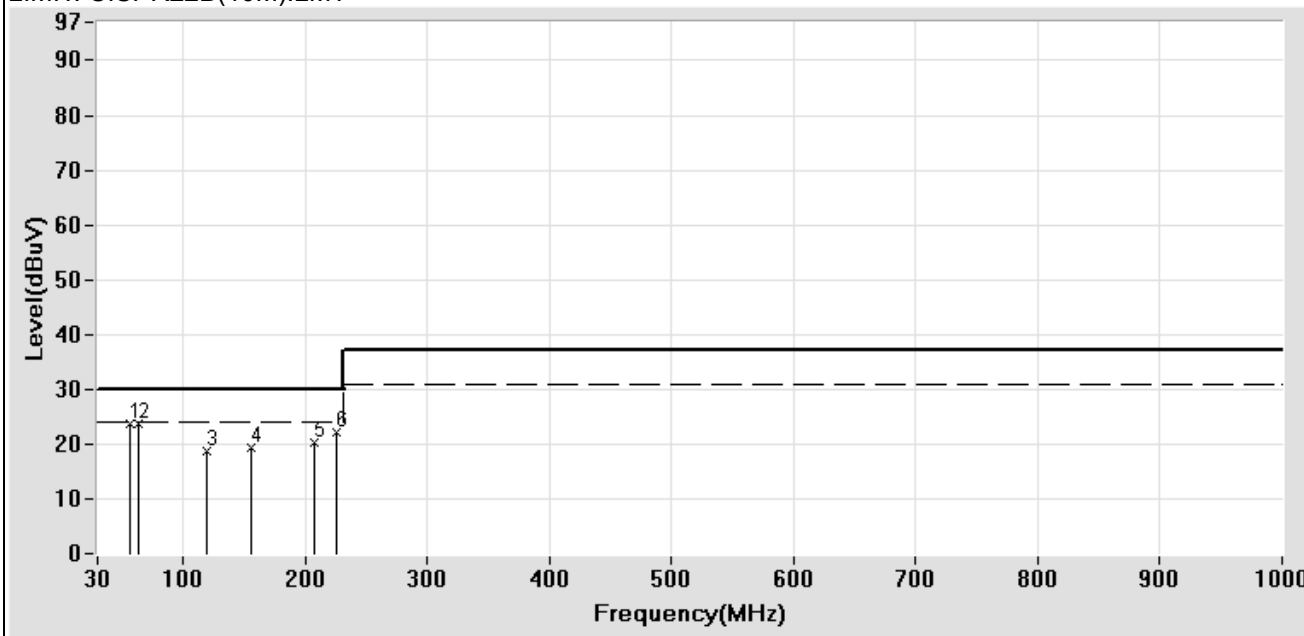

Test Mode: Mode 7: FULL LOAD (NSD10-48D5)

## Radiated Emission Measurement Data

EUT: Switching Power Supply CLIENT: MEAN WELL MODEL: NSD10-48D5 RATING: DC 48V Temperature: 14.0 °C Humidity: 57 %	POLARITY: Vertical DISTANCE: 10 m Serial No.: FILE/DATA#: MEAN WELL.emi/123 OPERATOR: Nigel TEST SITE: OATS1
---	---

Frequency	Factor	Meter Reading	Emission Level	Limits	Margin
(MHz)	(dB)	(dBμV)	(dBμV/m)	(dBμV/m)	(dB)
43.364 **	-15.03	38.56	23.53	30.00	-6.47
60.038 **	-19.72	42.56	22.84	30.00	-7.16
83.801 **	-19.69	42.59	22.90	30.00	-7.10
111.503 **	-15.64	35.55	19.91	30.00	-10.09
196.312 **	-10.57	33.49	22.92	30.00	-7.08
205.010 **	-10.43	30.82	20.39	30.00	-9.61

**Remark:**

1. “\*” Mark means readings are Peak Values.
2. “\*\*” Mark means readings are Quasi-Peak values.
3. Factor = Antenna Factor + Cable Loss – Pre-amplifier.

LIMIT: CISPR22B(10M).LMT

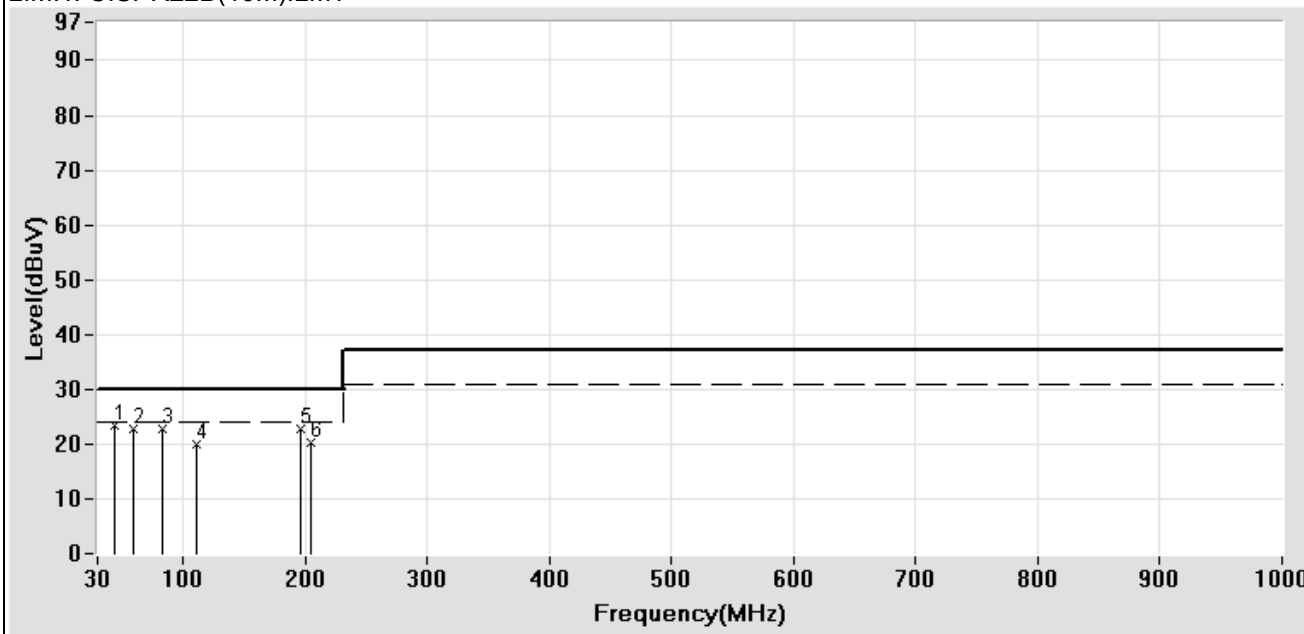

Test Mode: Mode 7: FULL LOAD (NSD10-48D5)

### Radiated Emission Measurement Data

EUT: Switching Power Supply CLIENT: MEAN WELL MODEL: NSD10-48D5 RATING: DC 48V Temperature: 18.0 °C Humidity: 79 %	POLARITY: Horizontal DISTANCE: 10 m Serial No.: FILE/DATA#: MEAN WELL.emi/281 OPERATOR: Nigel TEST SITE: OATS1
---	---

Frequency	Factor	Meter Reading	Emission Level	Limits	Margin
(MHz)	(dB)	(dBμV)	(dBμV/m)	(dBμV/m)	(dB)
58.214 **	-19.54	37.31	17.77	30.00	-12.23
70.893 **	-22.14	40.15	18.01	30.00	-11.99
84.486 **	-20.00	37.89	17.89	30.00	-12.11
115.310 **	-15.71	34.56	18.85	30.00	-11.15
192.649 **	-11.01	30.84	19.83	30.00	-10.17
229.971 **	-10.20	32.69	22.49	30.00	-7.51

**Remark:**

1. “\*” Mark means readings are Peak Values.
2. “\*\*” Mark means readings are Quasi-Peak values.
3. Factor = Antenna Factor + Cable Loss – Pre-amplifier.

LIMIT: CISPR22B(10M).LMT

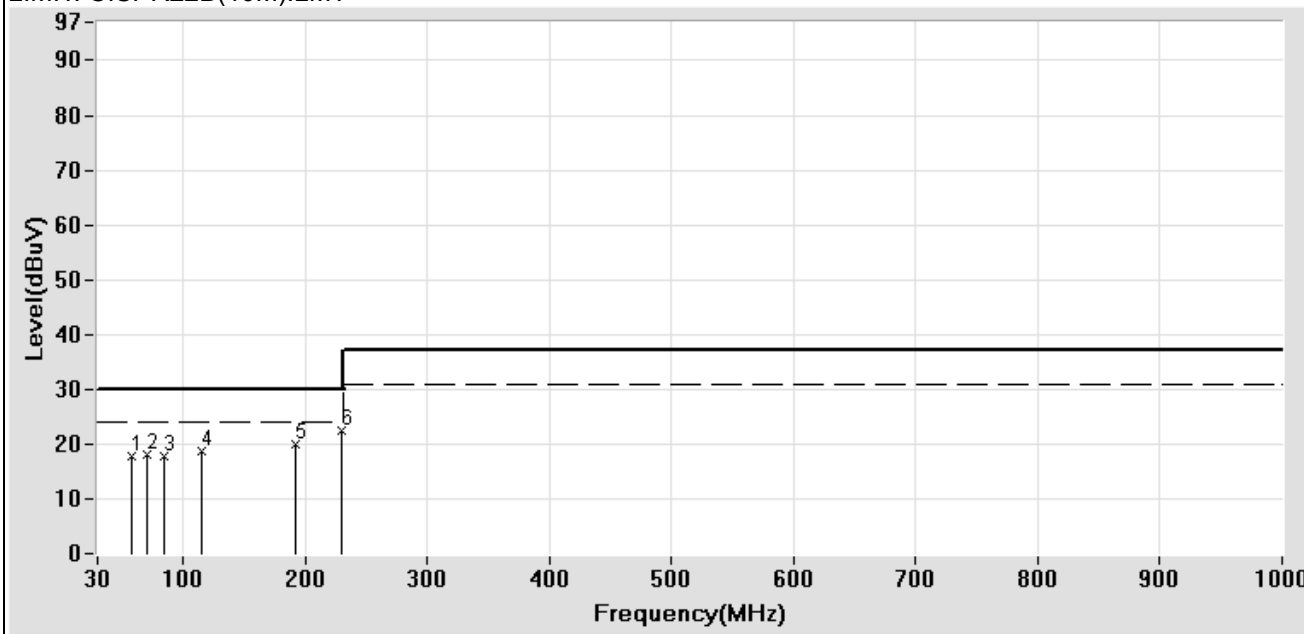

Test Mode: Mode 8: HALF LOAD (NSD10-48D5)

## Radiated Emission Measurement Data

EUT: Switching Power Supply CLIENT: MEAN WELL MODEL: NSD10-48D5 RATING: DC 48V Temperature: 18.0 °C Humidity: 79 %	POLARITY: Vertical DISTANCE: 10 m Serial No.: FILE/DATA#: MEAN WELL.emi/280 OPERATOR: Nigel TEST SITE: OATS1
---	---

Frequency	Factor	Meter Reading	Emission Level	Limits	Margin
(MHz)	(dB)	(dBμV)	(dBμV/m)	(dBμV/m)	(dB)
46.334 **	-16.27	39.25	22.98	30.00	-7.02
60.156 **	-20.10	40.97	20.87	30.00	-9.13
83.230 **	-20.13	40.26	20.13	30.00	-9.87
114.541 **	-15.78	34.85	19.07	30.00	-10.93
197.651 **	-11.02	33.22	22.20	30.00	-7.80
229.587 **	-10.21	32.73	22.52	30.00	-7.48

**Remark:**

1. “\*” Mark means readings are Peak Values.
2. “\*\*” Mark means readings are Quasi-Peak values.
3. Factor = Antenna Factor + Cable Loss – Pre-amplifier.

LIMIT: CISPR22B(10M).LMT

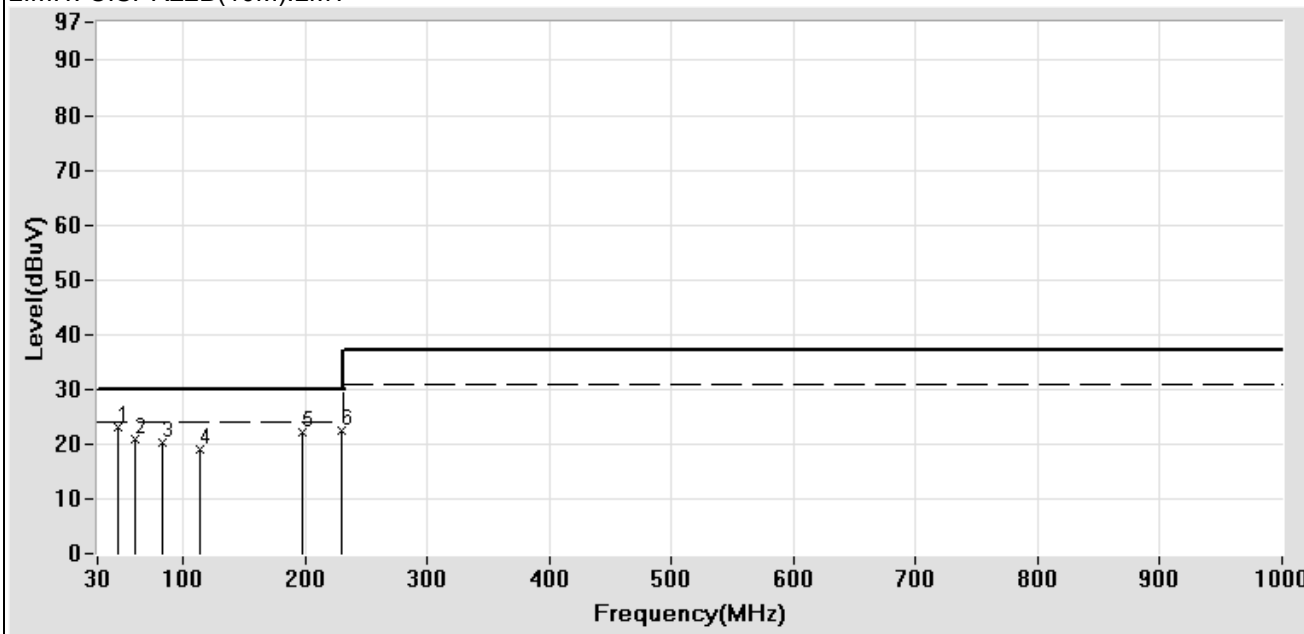

Test Mode: Mode 8: HALF LOAD (NSD10-48D5)

### Radiated Emission Measurement Data

EUT: Switching Power Supply CLIENT: MEAN WELL MODEL: NSD10-48D12 RATING: DC 48V Temperature: 14.0 °C Humidity: 57 %	POLARITY: Horizontal DISTANCE: 10 m Serial No.: FILE/DATA#: MEAN WELL.emi/119 OPERATOR: Nigel TEST SITE: OATS1
--	---

Frequency	Factor	Meter Reading	Emission Level	Limits	Margin
(MHz)	(dB)	(dBμV)	(dBμV/m)	(dBμV/m)	(dB)
57.757 **	-19.08	43.10	24.02	30.00	-5.98
66.096 **	-21.44	44.25	22.81	30.00	-7.19
84.943 **	-19.57	40.56	20.99	30.00	-9.01
113.531 **	-15.48	34.39	18.91	30.00	-11.09
196.681 **	-10.56	34.35	23.79	30.00	-6.21
206.813 **	-10.39	31.84	21.45	30.00	-8.55

**Remark:**

1. “\*” Mark means readings are Peak Values.
2. “\*\*” Mark means readings are Quasi-Peak values.
3. Factor = Antenna Factor + Cable Loss – Pre-amplifier.

LIMIT: CISPR22B(10M).LMT

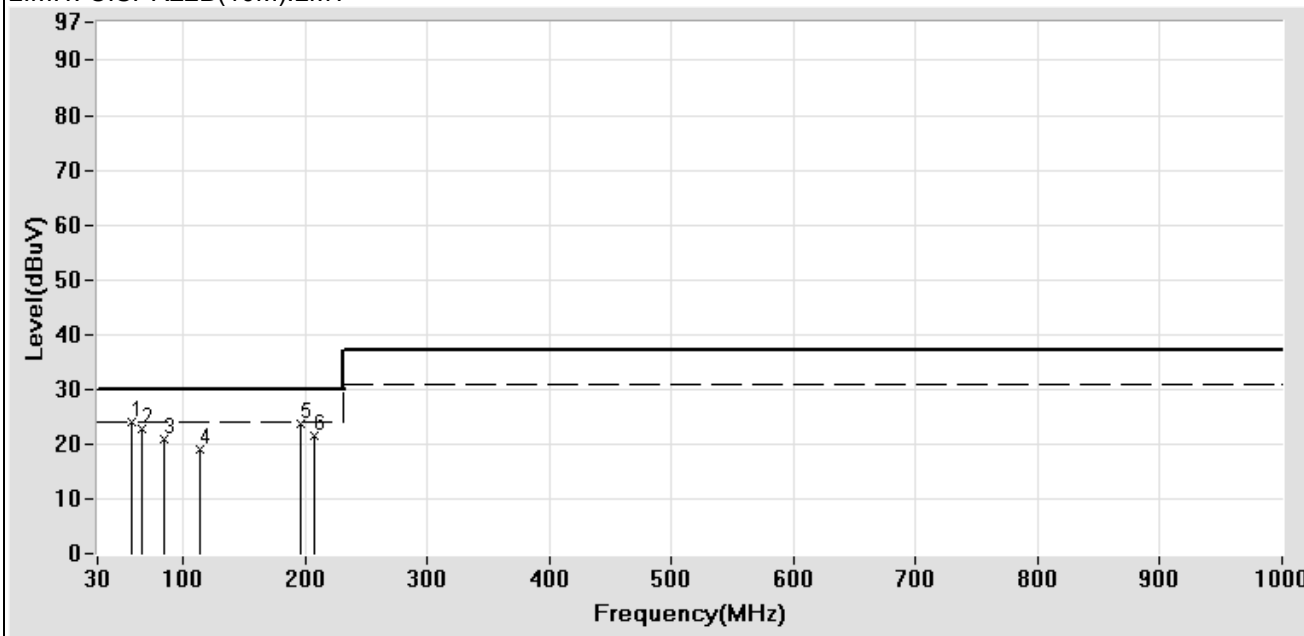

Test Mode: Mode 9: FULL LOAD (NSD10-48D12)

### Radiated Emission Measurement Data

EUT: Switching Power Supply	POLARITY: Vertical
CLIENT: MEAN WELL	DISTANCE: 10 m
MODEL: NSD10-48D12	Serial No.:
RATING: DC 48V	FILE/DATA#: MEAN WELL.emi/120
Temperature: 14.0 °C	OPERATOR: Nigel
Humidity: 57 %	TEST SITE: OATS1

Frequency (MHz)	Factor (dB)	Meter Reading (dBµV)	Emission Level (dBµV/m)	Limits (dBµV/m)	Margin (dB)
56.452 **	-18.71	42.45	23.74	30.00	-6.26
67.971 **	-21.65	40.48	18.83	30.00	-11.17
83.687 **	-19.70	40.59	20.89	30.00	-9.11
112.977 **	-15.53	37.56	22.03	30.00	-7.97
196.909 **	-10.57	32.74	22.17	30.00	-7.83
206.813 **	-10.39	31.17	20.78	30.00	-9.22

Remark:

1. “\*” Mark means readings are Peak Values.
2. “\*\*” Mark means readings are Quasi-Peak values.
3. Factor = Antenna Factor + Cable Loss – Pre-amplifier.

LIMIT: CISPR22B(10M).LMT

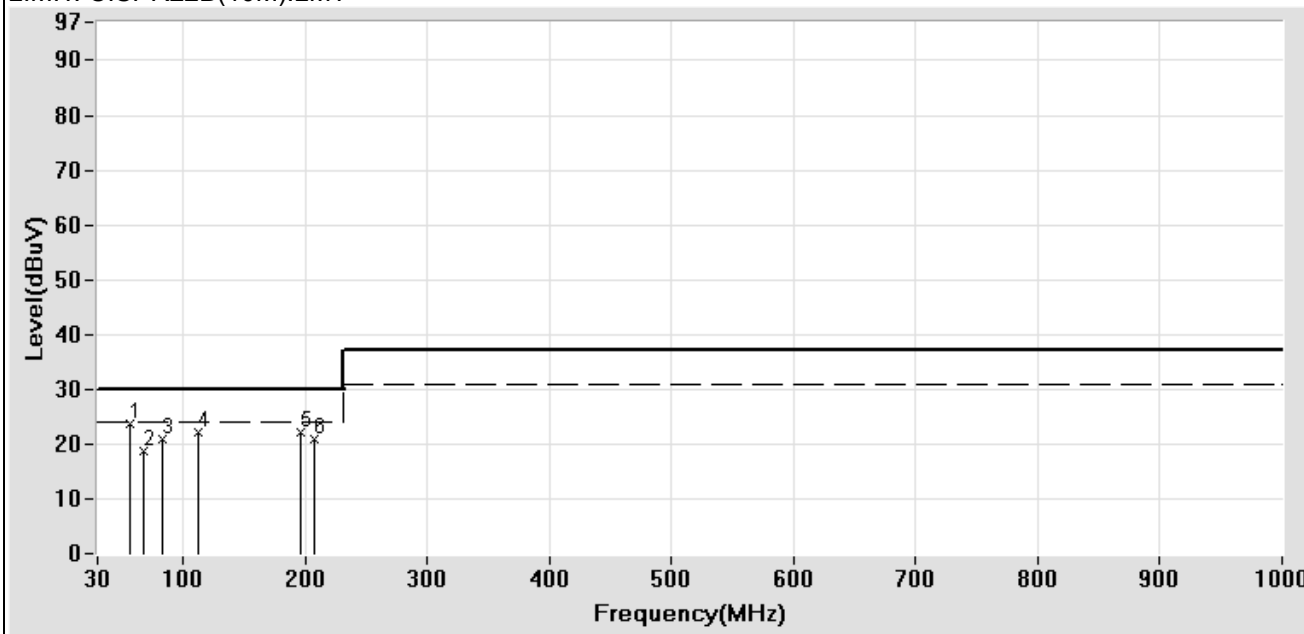

Test Mode: Mode 9: FULL LOAD (NSD10-48D12)



### Radiated Emission Measurement Data

EUT: Switching Power Supply CLIENT: MEAN WELL MODEL: NSD10-48D12 RATING: DC 48V Temperature: 18.0 °C Humidity: 79 %	POLARITY: Horizontal DISTANCE: 10 m Serial No.: FILE/DATA#: MEAN WELL.emi/289 OPERATOR: Nigel TEST SITE: OATS1
--	---

Frequency	Factor	Meter Reading	Emission Level	Limits	Margin
(MHz)	(dB)	(dBμV)	(dBμV/m)	(dBμV/m)	(dB)
57.414 **	-19.32	39.56	20.24	30.00	-9.76
70.775 **	-22.16	42.58	20.42	30.00	-9.58
85.515 **	-19.89	39.51	19.62	30.00	-10.38
115.698 **	-15.68	33.58	17.90	30.00	-12.10
161.482 **	-12.04	32.99	20.95	30.00	-9.05
228.048 **	-10.25	31.24	20.99	30.00	-9.01

**Remark:**

1. “\*” Mark means readings are Peak Values.
2. “\*\*” Mark means readings are Quasi-Peak values.
3. Factor = Antenna Factor + Cable Loss – Pre-amplifier.

LIMIT: CISPR22B(10M).LMT

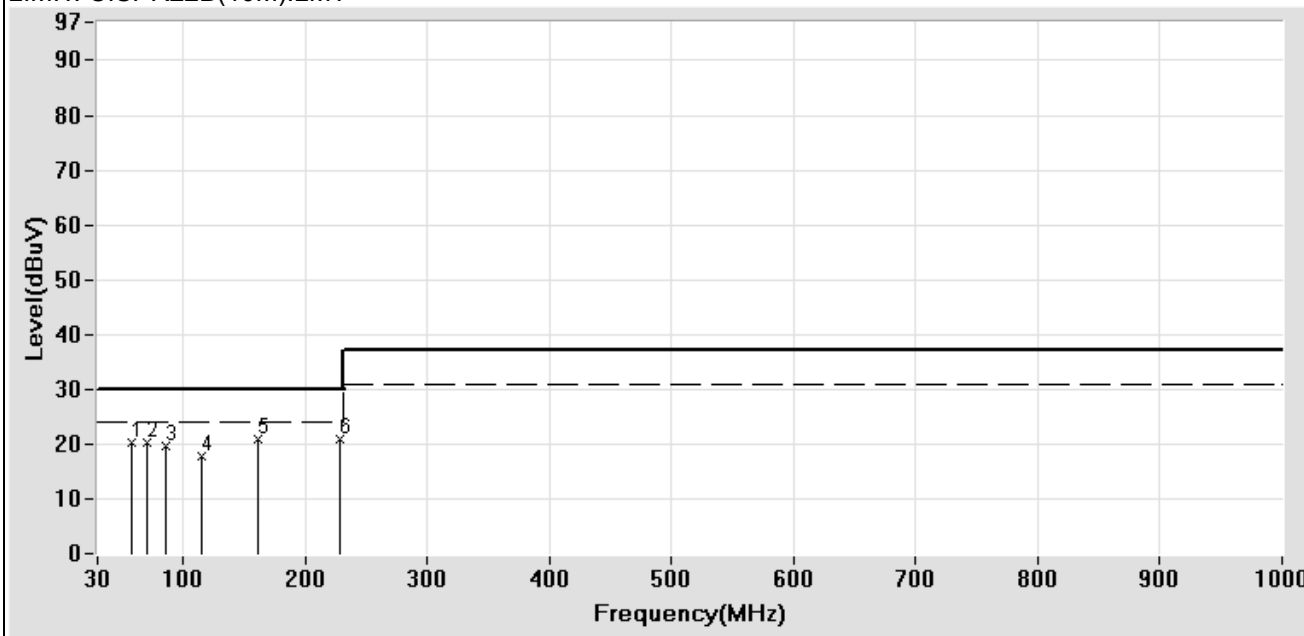

Test Mode: Mode 10: HALF LOAD (NSD10-48D12)

### Radiated Emission Measurement Data

EUT: Switching Power Supply CLIENT: MEAN WELL MODEL: NSD10-48D12 RATING: DC 48V Temperature: 18.0 °C Humidity: 79 %	POLARITY: Vertical DISTANCE: 10 m Serial No.: FILE/DATA#: MEAN WELL.emi/288 OPERATOR: Nigel TEST SITE: OATS1
--	---

Frequency	Factor	Meter Reading	Emission Level	Limits	Margin
(MHz)	(dB)	(dBμV)	(dBμV/m)	(dBμV/m)	(dB)
46.220 **	-16.24	39.72	23.48	30.00	-6.52
63.697 **	-21.25	42.44	21.19	30.00	-8.81
73.977 **	-21.77	43.72	21.95	30.00	-8.05
117.619 **	-15.53	36.25	20.72	30.00	-9.28
189.955 **	-11.01	33.95	22.94	30.00	-7.06
229.587 **	-10.21	31.45	21.24	30.00	-8.76

**Remark:**

1. “\*” Mark means readings are Peak Values.
2. “\*\*” Mark means readings are Quasi-Peak values.
3. Factor = Antenna Factor + Cable Loss – Pre-amplifier.

LIMIT: CISPR22B(10M).LMT

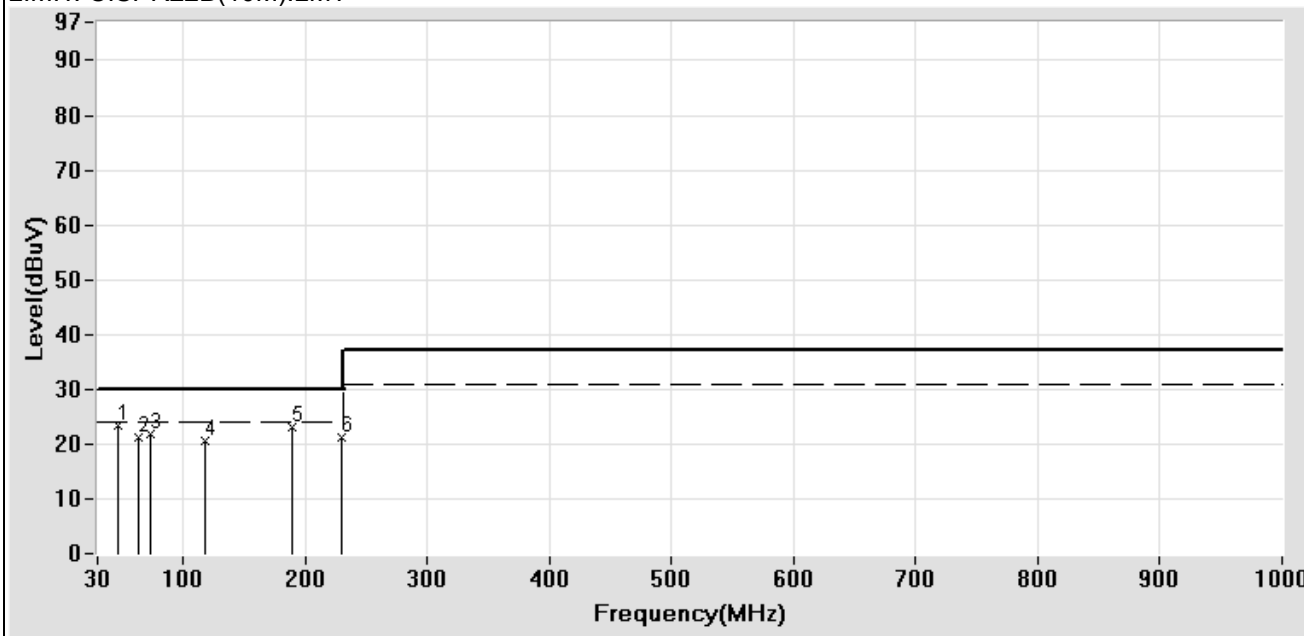

Test Mode: Mode 10: HALF LOAD (NSD10-48D12)

### Radiated Emission Measurement Data

EUT: Switching Power Supply CLIENT: MEAN WELL MODEL: NSD10-48D15 RATING: DC 48V Temperature: 14.0 °C Humidity: 57 %	POLARITY: Horizontal DISTANCE: 10 m Serial No.: FILE/DATA#: MEAN WELL.emi/111 OPERATOR: Nigel TEST SITE: OATS1
--	---

Frequency	Factor	Meter Reading	Emission Level	Limits	Margin
(MHz)	(dB)	(dBμV)	(dBμV/m)	(dBμV/m)	(dB)
59.699 **	-19.62	38.36	18.74	30.00	-11.26
69.751 **	-21.85	42.59	20.74	30.00	-9.26
85.400 **	-19.53	40.56	21.03	30.00	-8.97
110.212 **	-15.74	34.60	18.86	30.00	-11.14
121.458 **	-14.74	34.08	19.34	30.00	-10.66
206.813 **	-10.39	30.40	20.01	30.00	-9.99

**Remark:**

1. “ \* ” Mark means readings are Peak Values.
2. “ \*\* ” Mark means readings are Quasi-Peak values.
3. Factor = Antenna Factor + Cable Loss – Pre-amplifier.

LIMIT: CISPR22B(10M).LMT

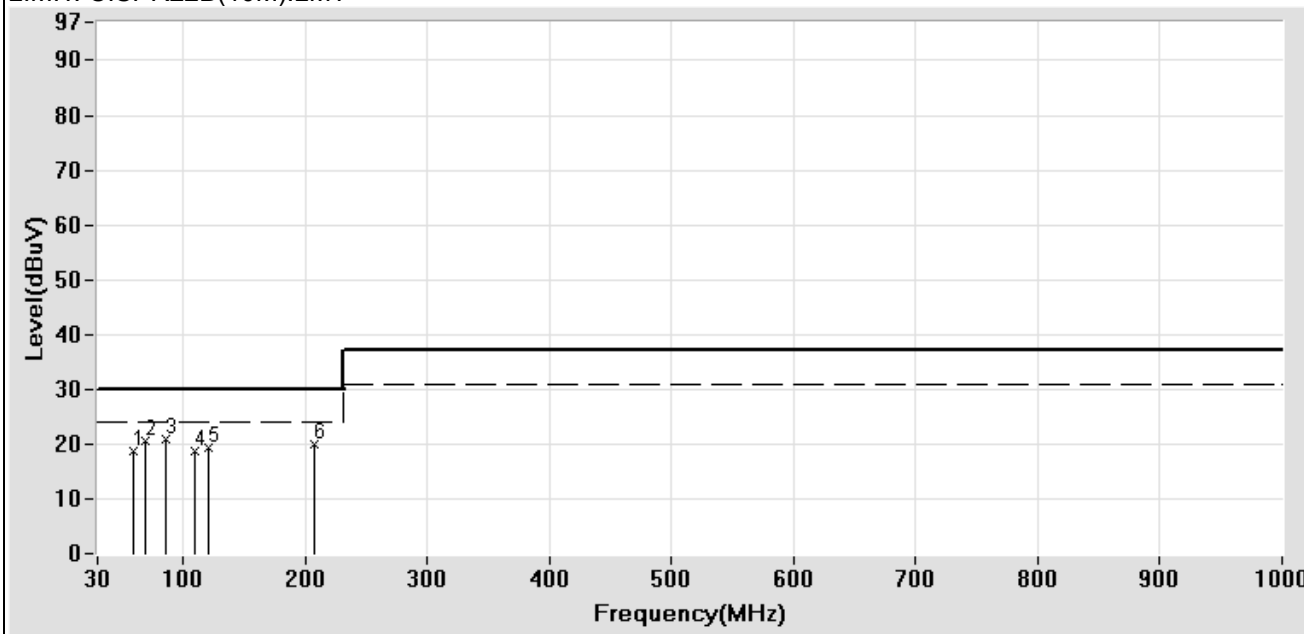

Test Mode: Mode 11: FULL LOAD (NSD10-48D15)

### Radiated Emission Measurement Data

EUT: Switching Power Supply CLIENT: MEAN WELL MODEL: NSD10-48D15 RATING: DC 48V Temperature: 14.0 °C Humidity: 57 %	POLARITY: Vertical DISTANCE: 10 m Serial No.: FILE/DATA#: MEAN WELL.emi/112 OPERATOR: Nigel TEST SITE: OATS1
--	---

Frequency	Factor	Meter Reading	Emission Level	Limits	Margin
(MHz)	(dB)	(dBμV)	(dBμV/m)	(dBμV/m)	(dB)
50.675 **	-17.14	40.58	23.44	30.00	-6.56
63.697 **	-20.90	41.58	20.68	30.00	-9.32
83.458 **	-19.72	40.12	20.40	30.00	-9.60
110.028 **	-15.76	35.51	19.75	30.00	-10.25
157.042 **	-11.85	30.80	18.95	30.00	-11.05
205.811 **	-10.41	30.21	19.80	30.00	-10.20

**Remark:**

1. “\*” Mark means readings are Peak Values.
2. “\*\*” Mark means readings are Quasi-Peak values.
3. Factor = Antenna Factor + Cable Loss – Pre-amplifier.

LIMIT: CISPR22B(10M).LMT

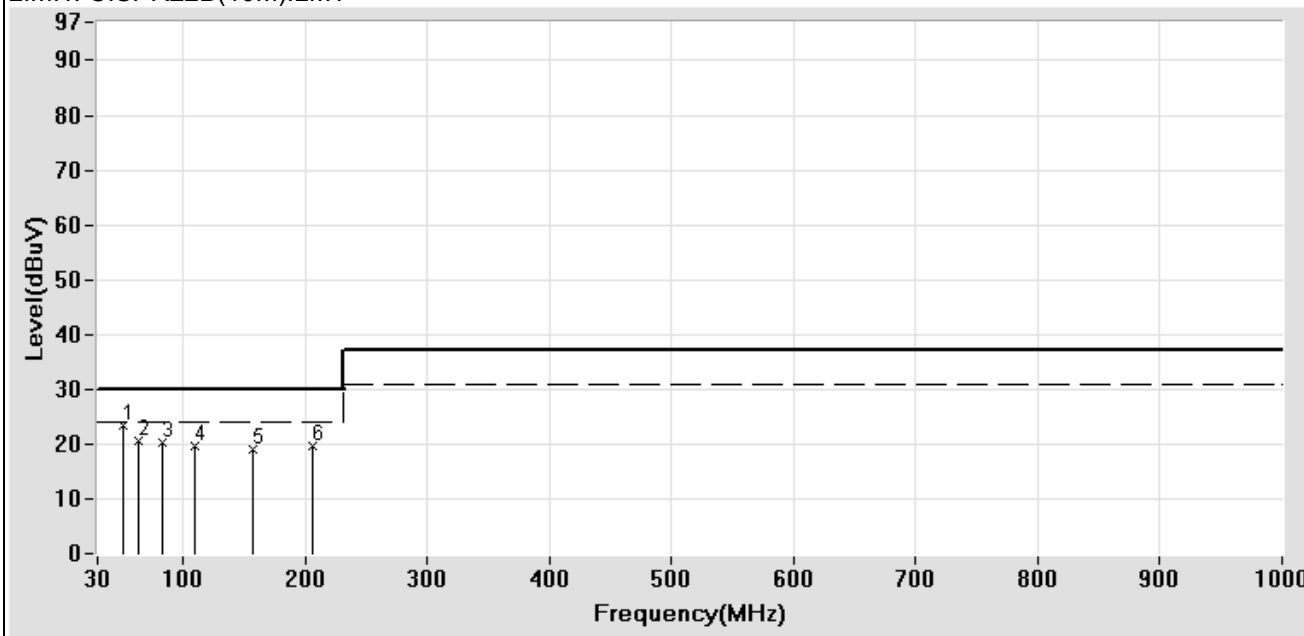

Test Mode: Mode 11: FULL LOAD (NSD10-48D15)

## Radiated Emission Measurement Data

EUT: Switching Power Supply CLIENT: MEAN WELL MODEL: NSD10-48D15 RATING: DC 48V Temperature: 18.0 °C Humidity: 79 %	POLARITY: Horizontal DISTANCE: 10 m Serial No.: FILE/DATA#: MEAN WELL.emi/286 OPERATOR: Nigel TEST SITE: OATS1
--	---

Frequency	Factor	Meter Reading	Emission Level	Limits	Margin
(MHz)	(dB)	(dBμV)	(dBμV/m)	(dBμV/m)	(dB)
39.138 **	-13.83	36.25	22.42	30.00	-7.58
57.643 **	-19.38	42.58	23.20	30.00	-6.80
70.436 **	-22.19	42.58	20.39	30.00	-9.61
110.581 **	-16.10	34.17	18.07	30.00	-11.93
197.651 **	-11.02	31.95	20.93	30.00	-9.07
229.971 **	-10.20	32.87	22.67	30.00	-7.33

**Remark:**

1. “\*” Mark means readings are Peak Values.
2. “\*\*” Mark means readings are Quasi-Peak values.
3. Factor = Antenna Factor + Cable Loss – Pre-amplifier.

LIMIT: CISPR22B(10M).LMT

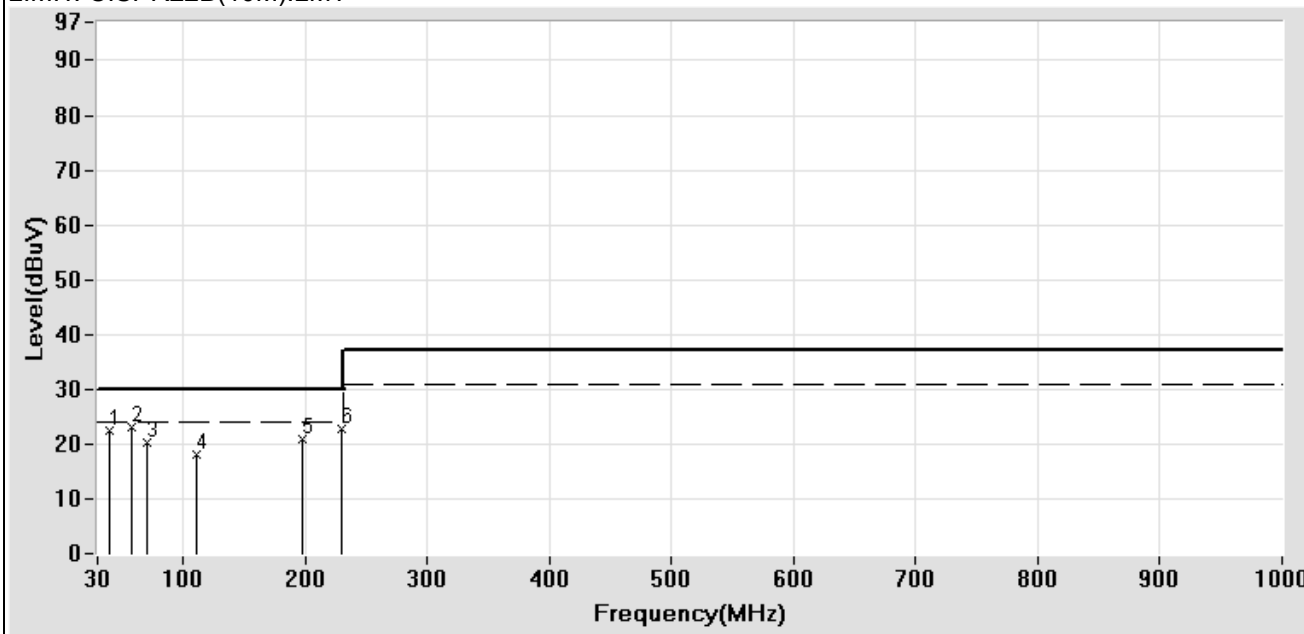

Test Mode: Mode 12: HALF LOAD (NSD10-48D15)

### Radiated Emission Measurement Data

EUT: Switching Power Supply CLIENT: MEAN WELL MODEL: NSD10-48D15 RATING: DC 48V Temperature: 18.0 °C Humidity: 79 %	POLARITY: Vertical DISTANCE: 10 m Serial No.: FILE/DATA#: MEAN WELL.emi/287 OPERATOR: Nigel TEST SITE: OATS1
--	---

Frequency	Factor	Meter Reading	Emission Level	Limits	Margin
(MHz)	(dB)	(dBμV)	(dBμV/m)	(dBμV/m)	(dB)
45.306 **	-15.99	37.99	22.00	30.00	-8.00
67.466 **	-21.95	43.66	21.71	30.00	-8.29
83.116 **	-20.14	40.72	20.58	30.00	-9.42
123.671 **	-14.80	36.04	21.24	30.00	-8.76
189.462 **	-11.02	32.89	21.87	30.00	-8.13
206.012 **	-10.86	33.26	22.40	30.00	-7.60

**Remark:**

1. “\*” Mark means readings are Peak Values.
2. “\*\*” Mark means readings are Quasi-Peak values.
3. Factor = Antenna Factor + Cable Loss – Pre-amplifier.

LIMIT: CISPR22B(10M).LMT

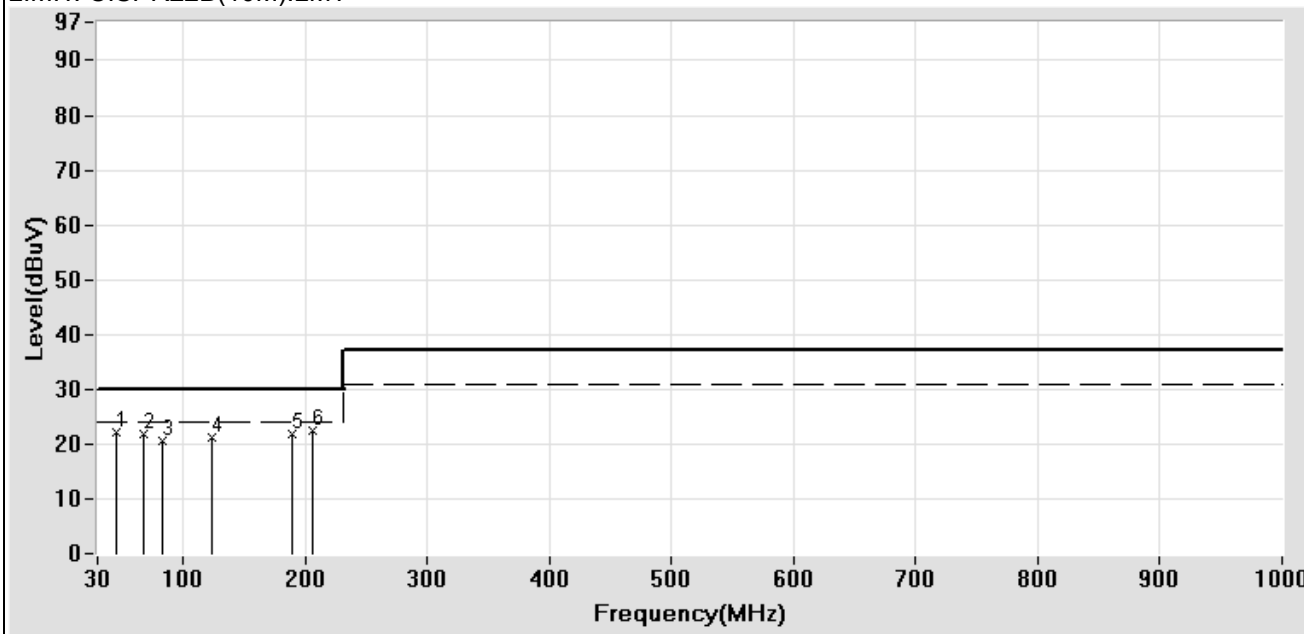

Test Mode: Mode 12: HALF LOAD (NSD10-48D15)

## Radiated Emission Measurement Data

EUT: Switching Power Supply CLIENT: MEAN WELL MODEL: NSD10-12S3 RATING: DC 12V Temperature: 14.0 °C Humidity: 57 %	POLARITY: Horizontal DISTANCE: 10 m Serial No.: FILE/DATA#: MEAN WELL.emi/71 OPERATOR: VICTOR TEST SITE: OATS1
---	---

Frequency	Factor	Meter Reading	Emission Level	Limits	Margin
(MHz)	(dB)	(dBμV)	(dBμV/m)	(dBμV/m)	(dB)
60.498 **	-19.87	37.92	18.05	30.00	-11.95
67.581 **	-21.60	40.83	19.23	30.00	-10.77
85.857 **	-19.46	39.18	19.72	30.00	-10.28
110.396 **	-15.73	33.86	18.13	30.00	-11.87
122.380 **	-14.60	32.60	18.00	30.00	-12.00
207.014 **	-10.38	30.33	19.95	30.00	-10.05

**Remark:**

1. “\*” Mark means readings are Peak Values.
2. “\*\*” Mark means readings are Quasi-Peak values.
3. Factor = Antenna Factor + Cable Loss – Pre-amplifier.

LIMIT: CISPR22B(10M).LMT

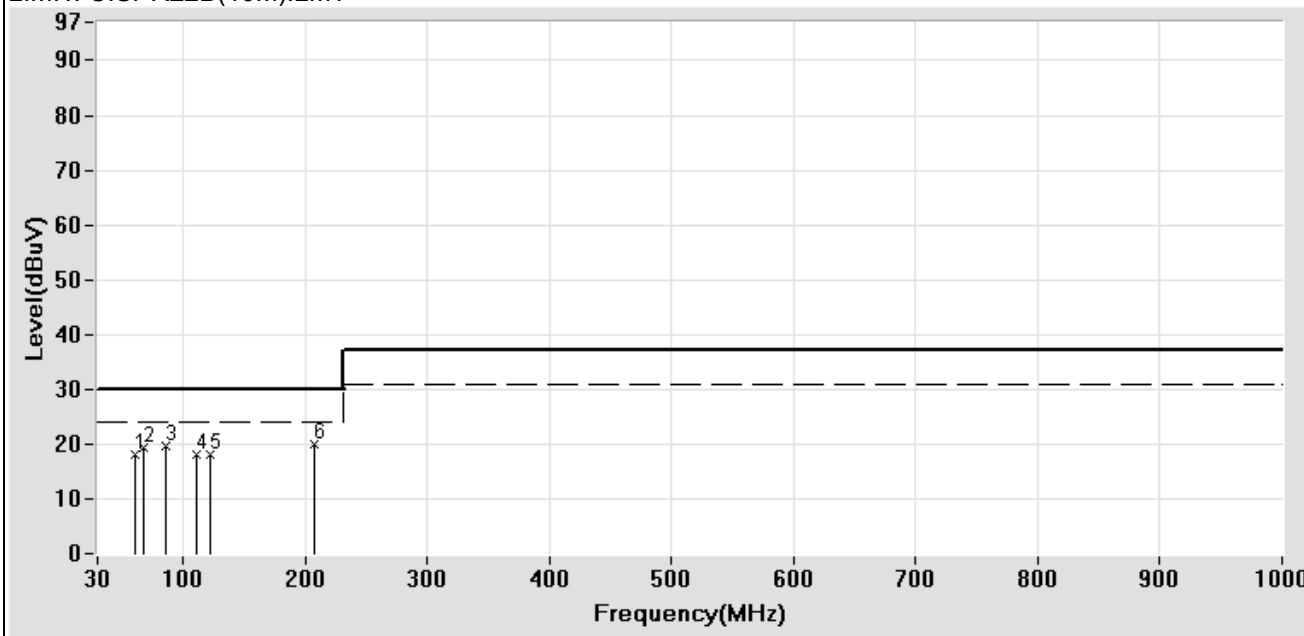

Test Mode: Mode 13: FULL LOAD (NSD10-12S3)

### Radiated Emission Measurement Data

EUT: Switching Power Supply CLIENT: MEAN WELL MODEL: NSD10-12S3 RATING: DC 12V Temperature: 14.0 °C Humidity: 57 %	POLARITY: Vertical DISTANCE: 10 m Serial No.: FILE/DATA#: MEAN WELL.emi/70 OPERATOR: VICTOR TEST SITE: OATS1
---	---

Frequency	Factor	Meter Reading	Emission Level	Limits	Margin
(MHz)	(dB)	(dBμV)	(dBμV/m)	(dBμV/m)	(dB)
43.935 **	-15.22	36.92	21.70	30.00	-8.30
57.072 **	-18.89	39.54	20.65	30.00	-9.35
85.743 **	-19.48	38.50	19.02	30.00	-10.98
110.581 **	-15.72	36.11	20.39	30.00	-9.61
122.749 **	-14.55	33.29	18.74	30.00	-11.26
206.613 **	-10.40	30.35	19.95	30.00	-10.05

Remark:

1. “\*” Mark means readings are Peak Values.
2. “\*\*” Mark means readings are Quasi-Peak values.
3. Factor = Antenna Factor + Cable Loss – Pre-amplifier.

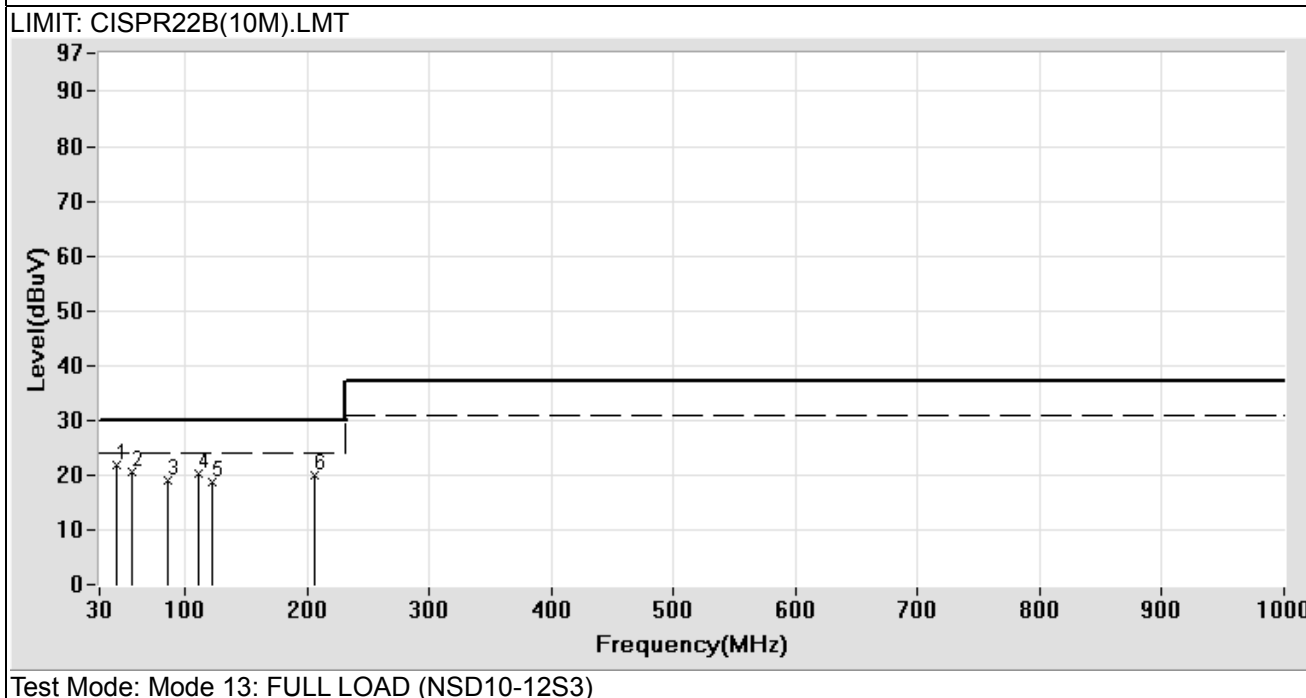



### Radiated Emission Measurement Data

EUT: Switching Power Supply	POLARITY: Horizontal
CLIENT: MEAN WELL	DISTANCE: 10 m
MODEL: NSD10-12S3	Serial No.:
RATING: DC 12V	FILE/DATA#: MEAN WELL.emi/256
Temperature: 18.0 °C	OPERATOR: Nigel
Humidity: 79 %	TEST SITE: OATS1

Frequency (MHz)	Factor (dB)	Meter Reading (dBµV)	Emission Level (dBµV/m)	Limits (dBµV/m)	Margin (dB)
57.643 **	-19.38	37.89	18.51	30.00	-11.49
74.092 **	-21.75	40.32	18.57	30.00	-11.43
84.372 **	-20.01	38.89	18.88	30.00	-11.12
114.541 **	-15.78	35.12	19.34	30.00	-10.66
158.789 **	-12.15	30.80	18.65	30.00	-11.35
207.270 **	-10.83	30.99	20.16	30.00	-9.84

**Remark:**

1. “\*” Mark means readings are Peak Values.
2. “\*\*” Mark means readings are Quasi-Peak values.
3. Factor = Antenna Factor + Cable Loss – Pre-amplifier.

LIMIT: CISPR22B(10M).LMT

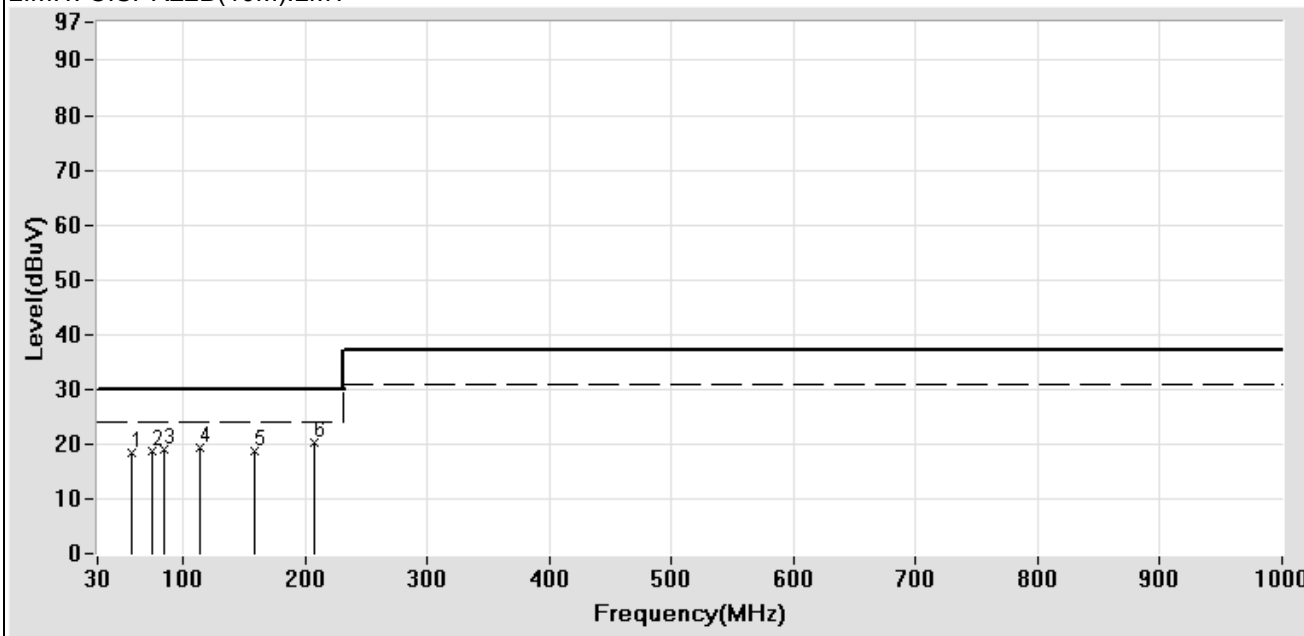

Test Mode: Mode 14: HALF LOAD (NSD10-12S3)

### Radiated Emission Measurement Data

EUT: Switching Power Supply CLIENT: MEAN WELL MODEL: NSD10-12S3 RATING: DC 12V Temperature: 18.0 °C Humidity: 79 %	POLARITY: Vertical DISTANCE: 10 m Serial No.: FILE/DATA#: MEAN WELL.emi/257 OPERATOR: Nigel TEST SITE: OATS1
---	---

Frequency	Factor	Meter Reading	Emission Level	Limits	Margin
(MHz)	(dB)	(dBμV)	(dBμV/m)	(dBμV/m)	(dB)
45.535 **	-16.06	38.56	22.50	30.00	-7.50
63.012 **	-21.01	41.23	20.22	30.00	-9.78
113.002 **	-15.89	36.45	20.56	30.00	-9.44
157.250 **	-12.25	30.96	18.71	30.00	-11.29
189.955 **	-11.01	32.05	21.04	30.00	-8.96
206.501 **	-10.85	31.25	20.40	30.00	-9.60

**Remark:**

1. " \* " Mark means readings are Peak Values.
2. " \*\* " Mark means readings are Quasi-Peak values.
3. Factor = Antenna Factor + Cable Loss – Pre-amplifier.

LIMIT: CISPR22B(10M).LMT

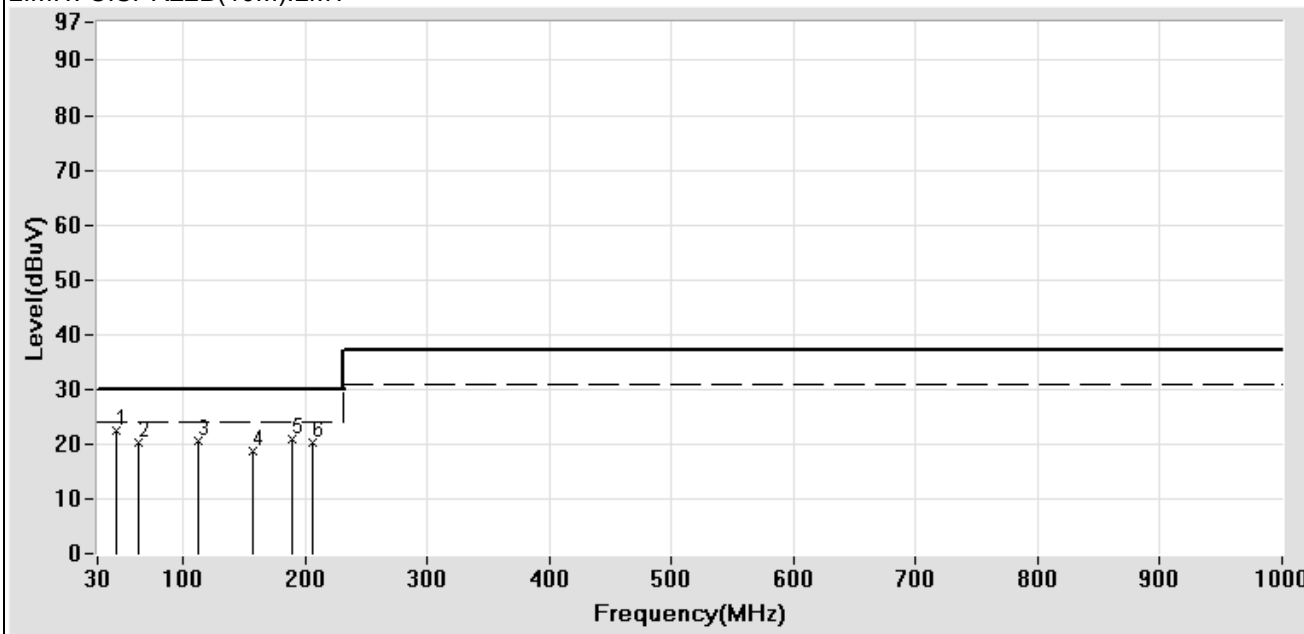

Test Mode: Mode 14: HALF LOAD (NSD10-12S3)

### Radiated Emission Measurement Data

EUT: Switching Power Supply CLIENT: MEAN WELL MODEL: NSD10-12S5 RATING: DC 12V Temperature: 14.0 °C Humidity: 57 %	POLARITY: Horizontal DISTANCE: 10 m Serial No.: FILE/DATA#: MEAN WELL.emi/81 OPERATOR: VICTOR TEST SITE: OATS1
---	---

Frequency	Factor	Meter Reading	Emission Level	Limits	Margin
(MHz)	(dB)	(dBμV)	(dBμV/m)	(dBμV/m)	(dB)
58.785 **	-19.37	38.15	18.78	30.00	-11.22
73.635 **	-21.43	40.58	19.15	30.00	-10.85
85.560 **	-19.51	39.47	19.96	30.00	-10.04
115.190 **	-15.34	34.60	19.26	30.00	-10.74
156.120 **	-11.90	30.61	18.71	30.00	-11.29
205.611 **	-10.42	30.28	19.86	30.00	-10.14

**Remark:**

1. “\*” Mark means readings are Peak Values.
2. “\*\*” Mark means readings are Quasi-Peak values.
3. Factor = Antenna Factor + Cable Loss – Pre-amplifier.

LIMIT: CISPR22B(10M).LMT

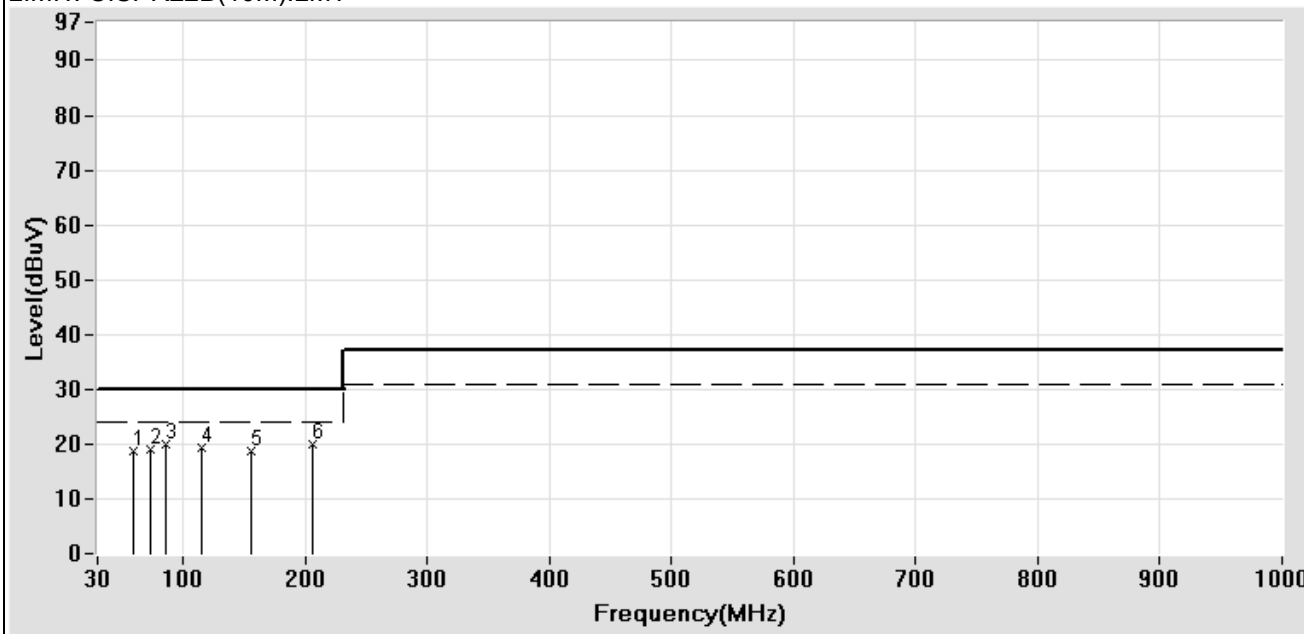

Test Mode: Mode 15: FULL LOAD (NSD10-12S5)

## Radiated Emission Measurement Data

EUT: Switching Power Supply CLIENT: MEAN WELL MODEL: NSD10-12S5 RATING: DC 12V Temperature: 14.0 °C Humidity: 57 %	POLARITY: Vertical DISTANCE: 10 m Serial No.: FILE/DATA#: MEAN WELL.emi/80 OPERATOR: VICTOR TEST SITE: OATS1
---	---

Frequency	Factor	Meter Reading	Emission Level	Limits	Margin
(MHz)	(dB)	(dBμV)	(dBμV/m)	(dBμV/m)	(dB)
50.446 **	-17.08	39.58	22.50	30.00	-7.50
60.955 **	-20.01	40.56	20.55	30.00	-9.45
85.857 **	-19.46	40.81	21.35	30.00	-8.65
110.028 **	-15.76	35.56	19.80	30.00	-10.20
195.759 **	-10.56	30.95	20.39	30.00	-9.61
206.212 **	-10.40	31.34	20.94	30.00	-9.06

Remark:

1. “\*” Mark means readings are Peak Values.
2. “\*\*” Mark means readings are Quasi-Peak values.
3. Factor = Antenna Factor + Cable Loss – Pre-amplifier.

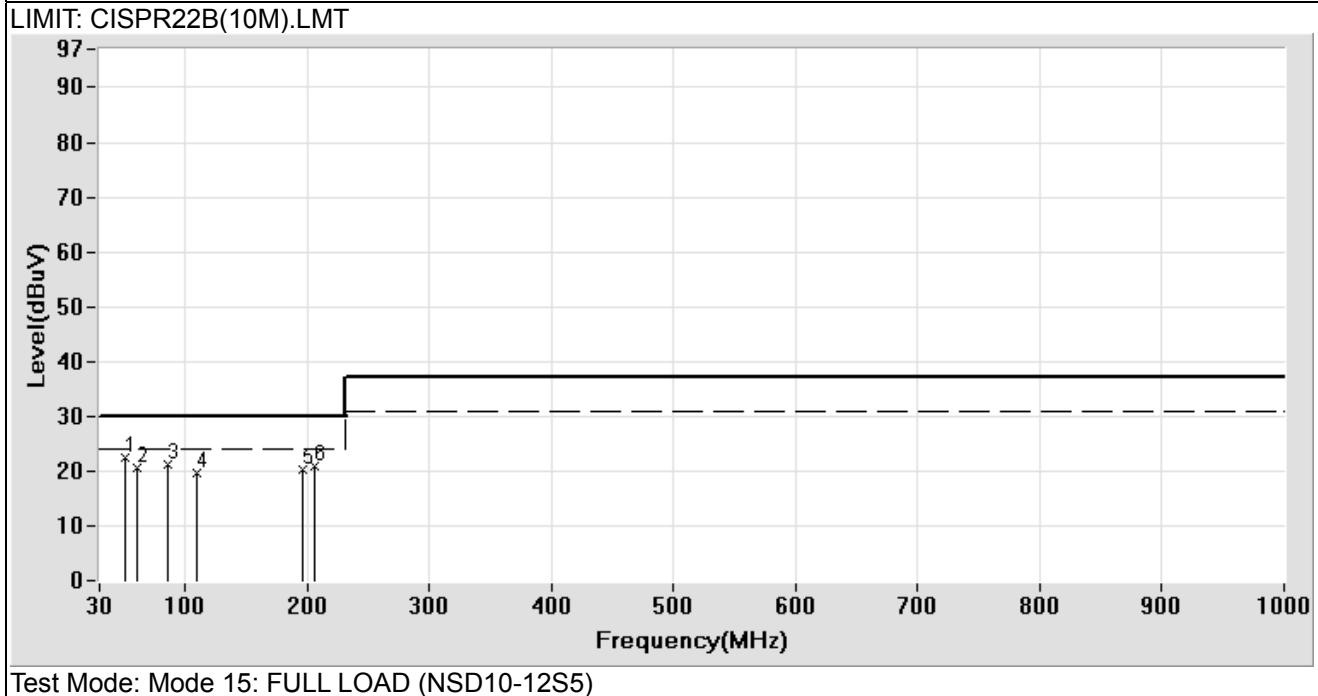

### Radiated Emission Measurement Data

EUT: Switching Power Supply CLIENT: MEAN WELL MODEL: NSD10-12S5 RATING: DC 12V Temperature: 18.0 °C Humidity: 79 %	POLARITY: Horizontal DISTANCE: 10 m Serial No.: FILE/DATA#: MEAN WELL.emi/267 OPERATOR: Nigel TEST SITE: OATS1
---	---

Frequency	Factor	Meter Reading	Emission Level	Limits	Margin
(MHz)	(dB)	(dBμV)	(dBμV/m)	(dBμV/m)	(dB)
50.218 **	-17.35	38.30	20.95	30.00	-9.05
66.895 **	-21.89	41.25	19.36	30.00	-10.64
84.829 **	-19.97	36.27	16.30	30.00	-13.70
133.386 **	-13.68	32.43	18.75	30.00	-11.25
162.637 **	-12.01	31.53	19.52	30.00	-10.48
206.501 **	-10.85	30.45	19.60	30.00	-10.40

**Remark:**

1. “\*” Mark means readings are Peak Values.
2. “\*\*” Mark means readings are Quasi-Peak values.
3. Factor = Antenna Factor + Cable Loss – Pre-amplifier.

LIMIT: CISPR22B(10M).LMT

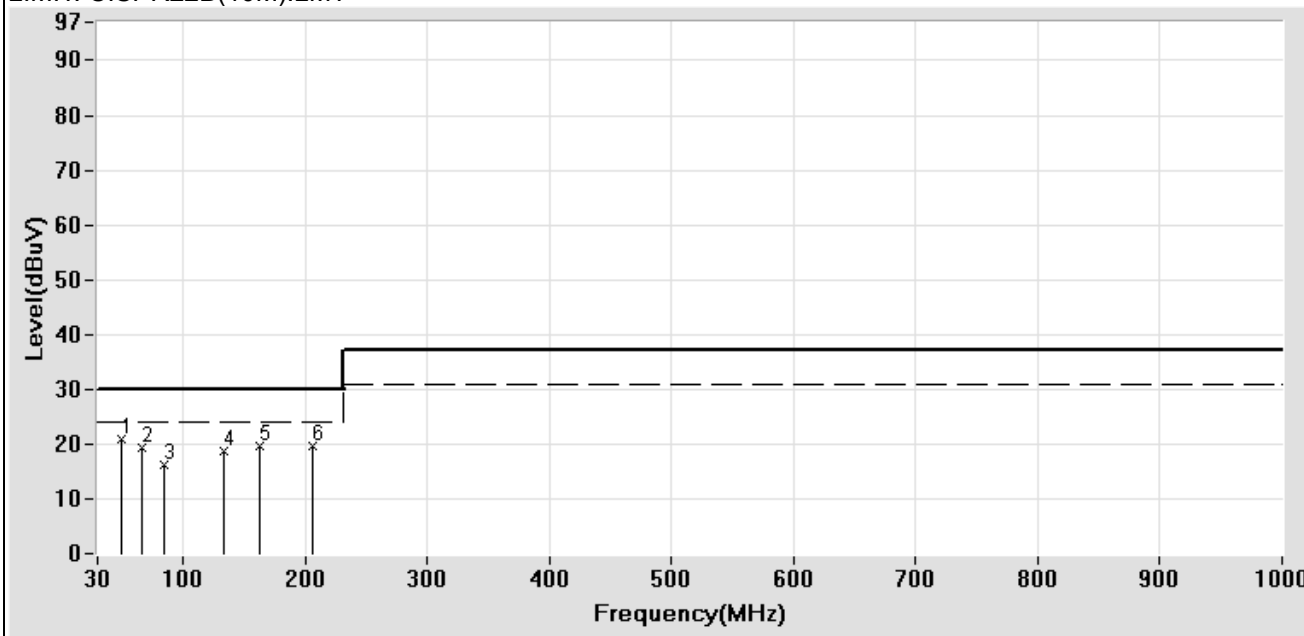

Test Mode: Mode 16: HALF LOAD (NSD10-12S5)

### Radiated Emission Measurement Data

EUT: Switching Power Supply CLIENT: MEAN WELL MODEL: NSD10-12S5 RATING: DC 12V Temperature: 18.0 °C Humidity: 79 %	POLARITY: Vertical DISTANCE: 10 m Serial No.: FILE/DATA#: MEAN WELL.emi/266 OPERATOR: Nigel TEST SITE: OATS1
---	---

Frequency	Factor	Meter Reading	Emission Level	Limits	Margin
(MHz)	(dB)	(dBμV)	(dBμV/m)	(dBμV/m)	(dB)
43.935 **	-15.54	38.82	23.28	30.00	-6.72
53.645 **	-18.28	39.68	21.40	30.00	-8.60
83.687 **	-20.08	38.74	18.66	30.00	-11.34
123.398 **	-14.84	33.56	18.72	30.00	-11.28
189.186 **	-11.02	31.80	20.78	30.00	-9.22
207.655 **	-10.81	32.20	21.39	30.00	-8.61

**Remark:**

1. “\*” Mark means readings are Peak Values.
2. “\*\*” Mark means readings are Quasi-Peak values.
3. Factor = Antenna Factor + Cable Loss – Pre-amplifier.

LIMIT: CISPR22B(10M).LMT

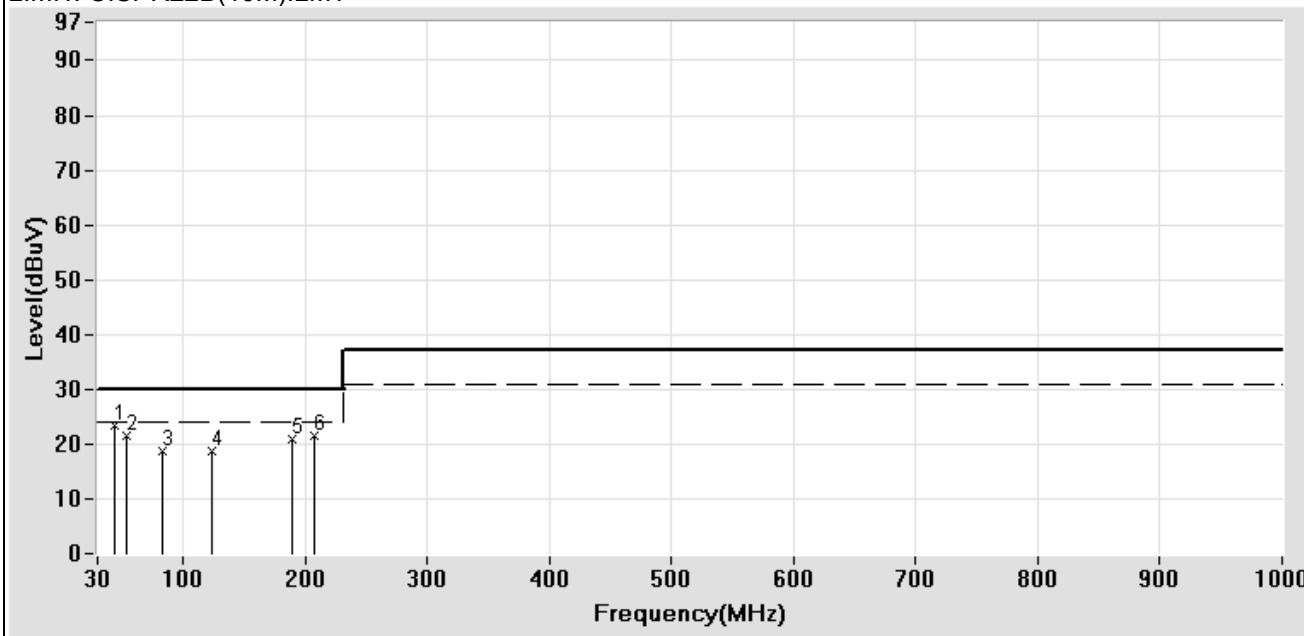

Test Mode: Mode 16: HALF LOAD (NSD10-12S5)

### Radiated Emission Measurement Data

EUT: Switching Power Supply CLIENT: MEAN WELL MODEL: NSD10-12S9 RATING: DC 12V Temperature: 14.0 °C Humidity: 57 %	POLARITY: Horizontal DISTANCE: 10 m Serial No.: FILE/DATA#: MEAN WELL.emi/65 OPERATOR: VICTOR TEST SITE: OATS1
---	---

Frequency	Factor	Meter Reading	Emission Level	Limits	Margin
(MHz)	(dB)	(dBμV)	(dBμV/m)	(dBμV/m)	(dB)
58.230 **	-19.22	35.00	15.78	30.00	-14.22
67.124 **	-21.55	36.15	14.60	30.00	-15.40
85.629 **	-19.49	37.18	17.69	30.00	-12.31
109.474 **	-15.83	35.09	19.26	30.00	-10.74
121.827 **	-14.69	34.06	19.37	30.00	-10.63
220.641 **	-9.98	30.00	20.02	30.00	-9.98

**Remark:**

1. “\*” Mark means readings are Peak Values.
2. “\*\*” Mark means readings are Quasi-Peak values.
3. Factor = Antenna Factor + Cable Loss – Pre-amplifier.

LIMIT: CISPR22B(10M).LMT

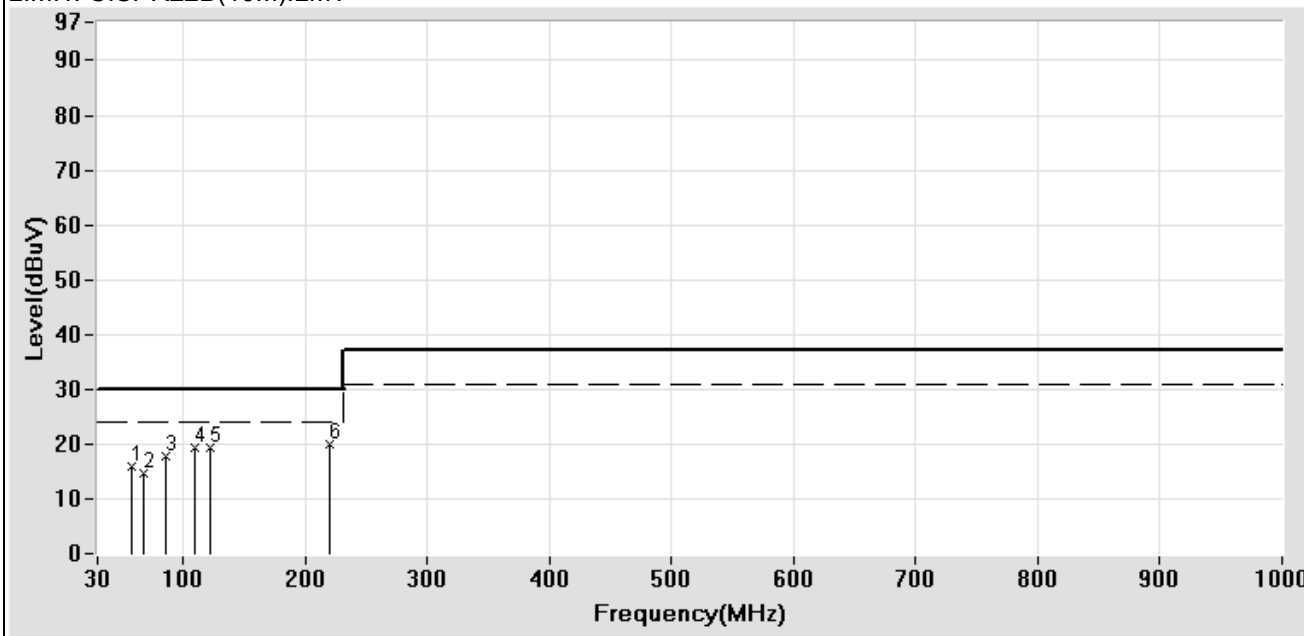

Test Mode: Mode 17: FULL LOAD (NSD10-12S9)

### Radiated Emission Measurement Data

EUT: Switching Power Supply	POLARITY: Vertical
CLIENT: MEAN WELL	DISTANCE: 10 m
MODEL: NSD10-12S9	Serial No.:
RATING: DC 12V	FILE/DATA#: MEAN WELL.emi/63
Temperature: 14.0 °C	OPERATOR: VICTOR
Humidity: 57 %	TEST SITE: OATS1

Frequency (MHz)	Factor (dB)	Meter Reading (dBµV)	Emission Level (dBµV/m)	Limits (dBµV/m)	Margin (dB)
57.186 **	-18.93	39.38	20.45	30.00	-9.55
63.583 **	-20.86	39.45	18.59	30.00	-11.41
84.943 **	-19.57	37.07	17.50	30.00	-12.50
110.396 **	-15.73	36.82	21.09	30.00	-8.91
127.174 **	-13.90	32.36	18.46	30.00	-11.54
220.040 **	-9.99	32.66	22.67	30.00	-7.33

Remark:

1. “\*” Mark means readings are Peak Values.
2. “\*\*” Mark means readings are Quasi-Peak values.
3. Factor = Antenna Factor + Cable Loss – Pre-amplifier.

LIMIT: CISPR22B(10M).LMT

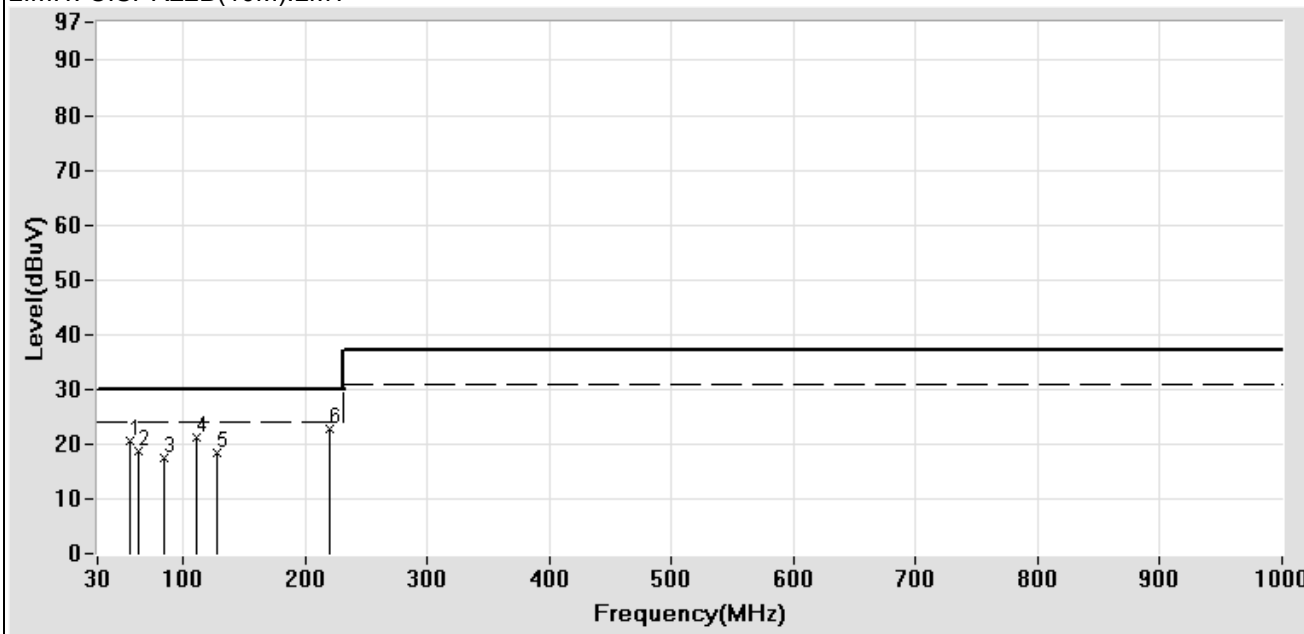

Test Mode: Mode 17: FULL LOAD (NSD10-12S9)



### Radiated Emission Measurement Data

EUT: Switching Power Supply CLIENT: MEAN WELL MODEL: NSD10-12S9 RATING: DC 12V Temperature: 18.0 °C Humidity: 79 %	POLARITY: Horizontal DISTANCE: 10 m Serial No.: FILE/DATA#: MEAN WELL.emi/272 OPERATOR: Nigel TEST SITE: OATS1
---	---

Frequency	Factor	Meter Reading	Emission Level	Limits	Margin
(MHz)	(dB)	(dBμV)	(dBμV/m)	(dBμV/m)	(dB)
59.927 **	-20.03	39.56	19.53	30.00	-10.47
72.949 **	-21.88	40.89	19.01	30.00	-10.99
85.629 **	-19.88	38.51	18.63	30.00	-11.37
115.695 **	-15.68	32.51	16.83	30.00	-13.17
182.260 **	-11.21	30.71	19.50	30.00	-10.50
208.424 **	-10.80	30.68	19.88	30.00	-10.12

**Remark:**

1. “ \* ” Mark means readings are Peak Values.
2. “ \*\* ” Mark means readings are Quasi-Peak values.
3. Factor = Antenna Factor + Cable Loss – Pre-amplifier.

LIMIT: CISPR22B(10M).LMT

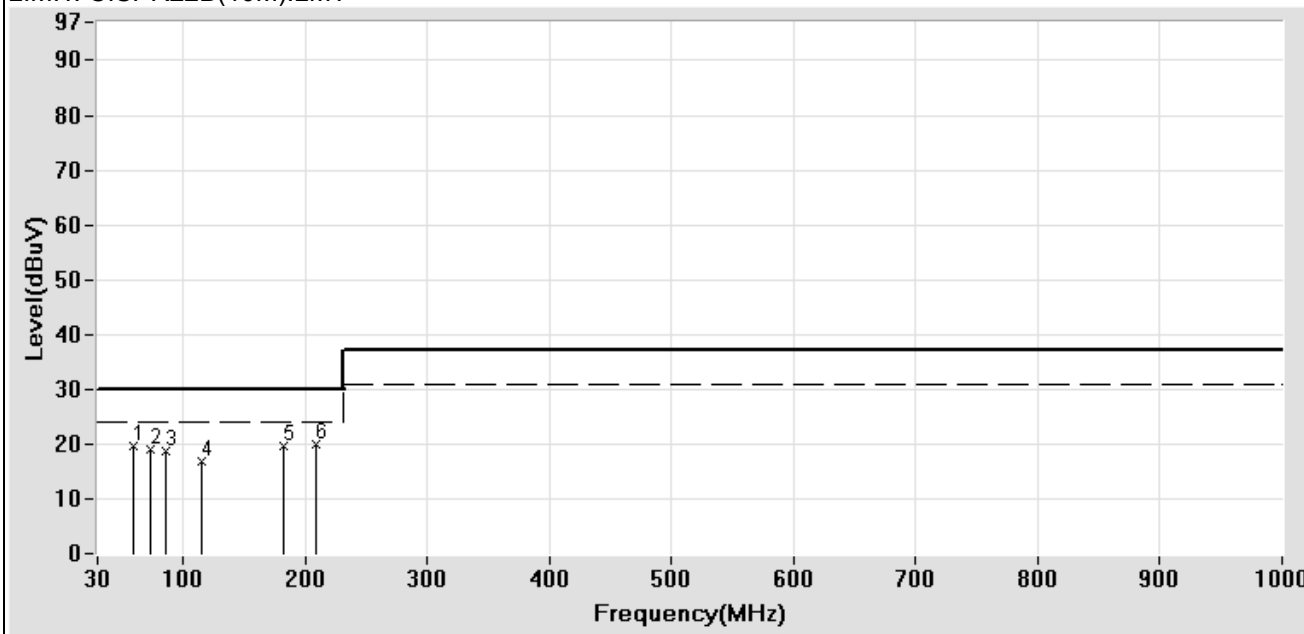

Test Mode: Mode 18: HALF LOAD (NSD10-12S9)

### Radiated Emission Measurement Data

EUT: Switching Power Supply CLIENT: MEAN WELL MODEL: NSD10-12S9 RATING: DC 12V Temperature: 18.0 °C Humidity: 79 %	POLARITY: Vertical DISTANCE: 10 m Serial No.: FILE/DATA#: MEAN WELL.emi/273 OPERATOR: Nigel TEST SITE: OATS1
---	---

Frequency	Factor	Meter Reading	Emission Level	Limits	Margin
(MHz)	(dB)	(dBμV)	(dBμV/m)	(dBμV/m)	(dB)
50.332 **	-17.38	40.92	23.54	30.00	-6.46
60.613 **	-20.25	41.52	21.27	30.00	-8.73
84.715 **	-19.98	39.53	19.55	30.00	-10.45
116.080 **	-15.65	34.83	19.18	30.00	-10.82
190.340 **	-11.01	30.51	19.50	30.00	-10.50
208.424 **	-10.80	31.08	20.28	30.00	-9.72

**Remark:**

1. “ \* ” Mark means readings are Peak Values.
2. “ \*\* ” Mark means readings are Quasi-Peak values.
3. Factor = Antenna Factor + Cable Loss – Pre-amplifier.

LIMIT: CISPR22B(10M).LMT

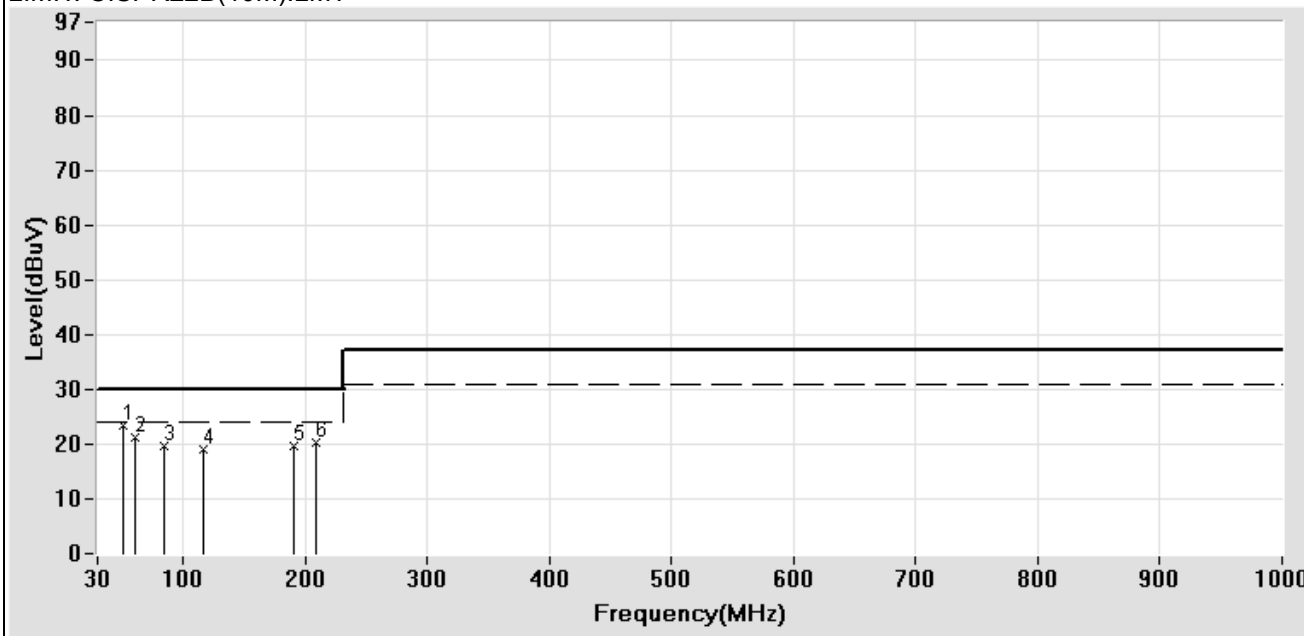

Test Mode: Mode 18: HALF LOAD (NSD10-12S9)

### Radiated Emission Measurement Data

EUT: Switching Power Supply CLIENT: MEAN WELL MODEL: NSD10-12S12 RATING: DC 12V Temperature: 14.0 °C Humidity: 57 %	POLARITY: Horizontal DISTANCE: 10 m Serial No.: FILE/DATA#: MEAN WELL.emi/62 OPERATOR: VICTOR TEST SITE: OATS1
--	---

Frequency	Factor	Meter Reading	Emission Level	Limits	Margin
(MHz)	(dB)	(dBμV)	(dBμV/m)	(dBμV/m)	(dB)
57.871 **	-19.11	36.16	17.05	30.00	-12.95
72.835 **	-21.54	36.25	14.71	30.00	-15.29
85.971 **	-19.45	36.57	17.12	30.00	-12.88
110.396 **	-15.73	32.40	16.67	30.00	-13.33
122.565 **	-14.58	33.35	18.77	30.00	-11.23
220.240 **	-9.99	31.09	21.10	30.00	-8.90

**Remark:**

1. “ \* ” Mark means readings are Peak Values.
2. “ \*\* ” Mark means readings are Quasi-Peak values.
3. Factor = Antenna Factor + Cable Loss – Pre-amplifier.

LIMIT: CISPR22B(10M).LMT

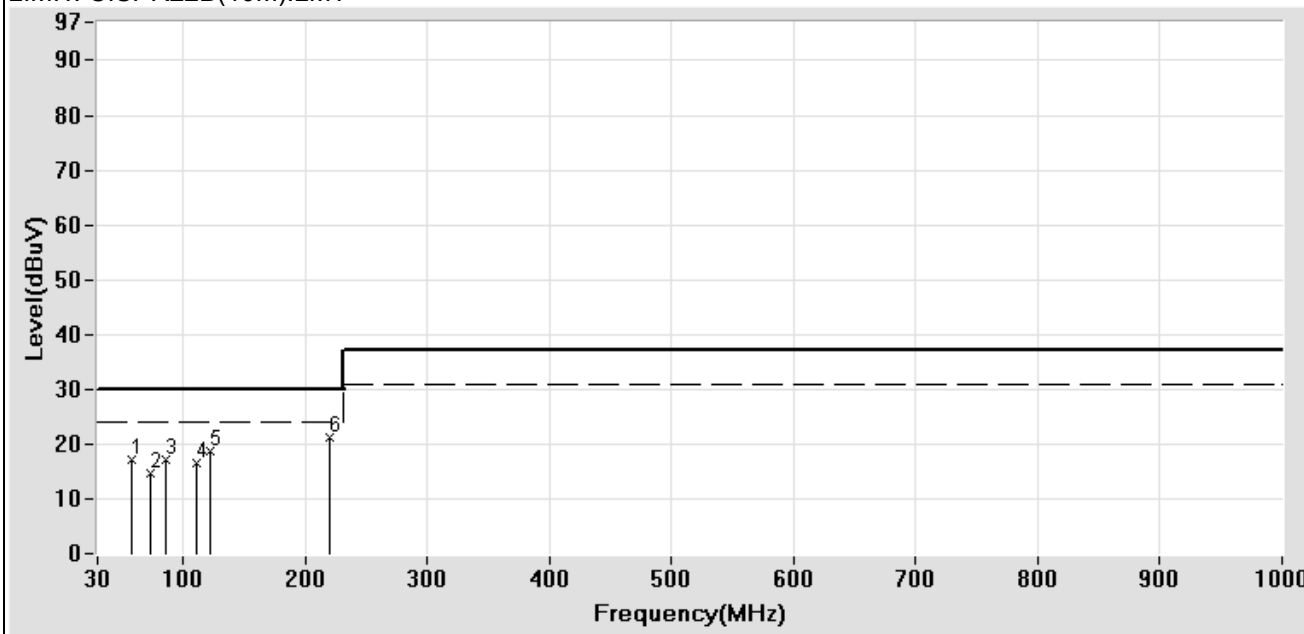

Test Mode: Mode 19: FULL LOAD (NSD10-12S12)

### Radiated Emission Measurement Data

EUT: Switching Power Supply CLIENT: MEAN WELL MODEL: NSD10-12S12 RATING: DC 12V Temperature: 14.0 °C Humidity: 57 %	POLARITY: Vertical DISTANCE: 10 m Serial No.: FILE/DATA#: MEAN WELL.emi/61 OPERATOR: VICTOR TEST SITE: OATS1
--	---

Frequency	Factor	Meter Reading	Emission Level	Limits	Margin
(MHz)	(dB)	(dBμV)	(dBμV/m)	(dBμV/m)	(dB)
46.492 **	-15.99	39.11	23.12	30.00	-6.88
56.430 **	-18.70	42.36	23.66	30.00	-6.34
85.330 **	-19.53	40.60	21.07	30.00	-8.93
109.474 **	-15.83	38.44	22.61	30.00	-7.39
126.621 **	-13.98	34.53	20.55	30.00	-9.45
220.641 **	-9.98	32.74	22.76	30.00	-7.24

**Remark:**

1. “ \* ” Mark means readings are Peak Values.
2. “ \*\* ” Mark means readings are Quasi-Peak values.
3. Factor = Antenna Factor + Cable Loss – Pre-amplifier.

LIMIT: CISPR22B(10M).LMT

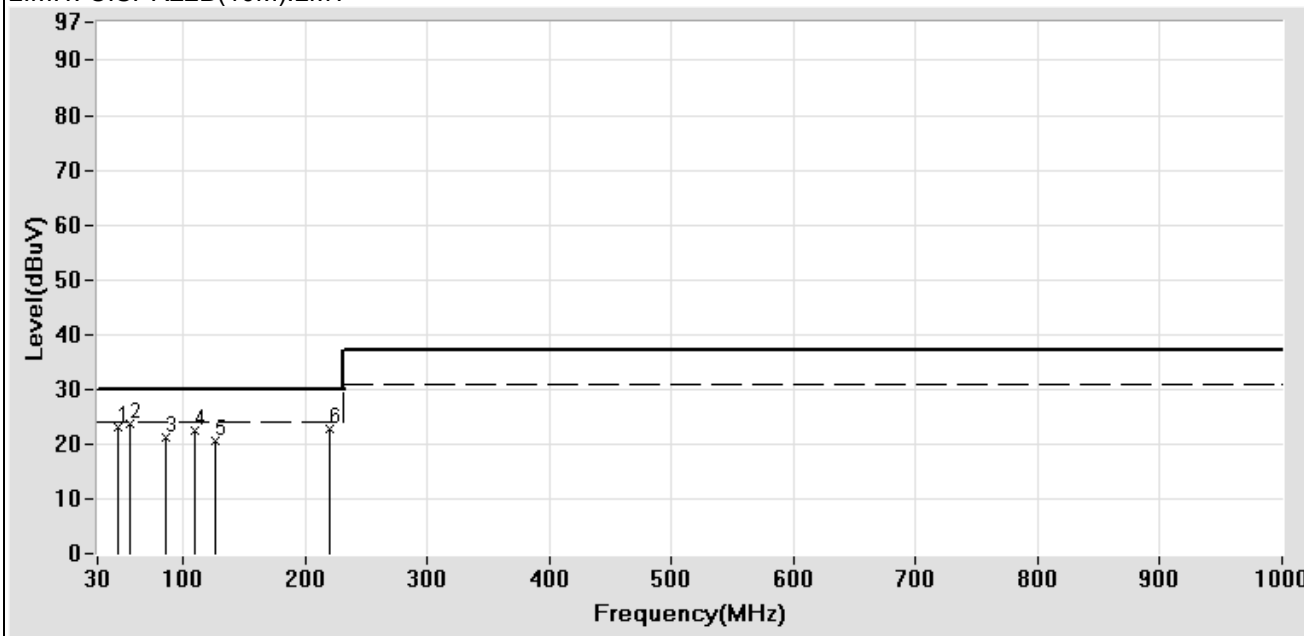

Test Mode: Mode 19: FULL LOAD (NSD10-12S12)

## Radiated Emission Measurement Data

EUT: Switching Power Supply CLIENT: MEAN WELL MODEL: NSD10-12S12 RATING: DC 12V Temperature: 18.0 °C Humidity: 79 %	POLARITY: Horizontal DISTANCE: 10 m Serial No.: FILE/DATA#: MEAN WELL.emi/252 OPERATOR: Nigel TEST SITE: OATS1
--	---

Frequency	Factor	Meter Reading	Emission Level	Limits	Margin
(MHz)	(dB)	(dBμV)	(dBμV/m)	(dBμV/m)	(dB)
58.671 **	-19.68	37.89	18.21	30.00	-11.79
72.835 **	-21.91	40.12	18.21	30.00	-11.79
84.601 **	-19.99	39.56	19.57	30.00	-10.43
123.390 **	-14.84	31.54	16.70	30.00	-13.30
167.254 **	-11.88	30.79	18.91	30.00	-11.09
205.346 **	-10.88	30.67	19.79	30.00	-10.21

**Remark:**

1. “\*” Mark means readings are Peak Values.
2. “\*\*” Mark means readings are Quasi-Peak values.
3. Factor = Antenna Factor + Cable Loss – Pre-amplifier.

LIMIT: CISPR22B(10M).LMT

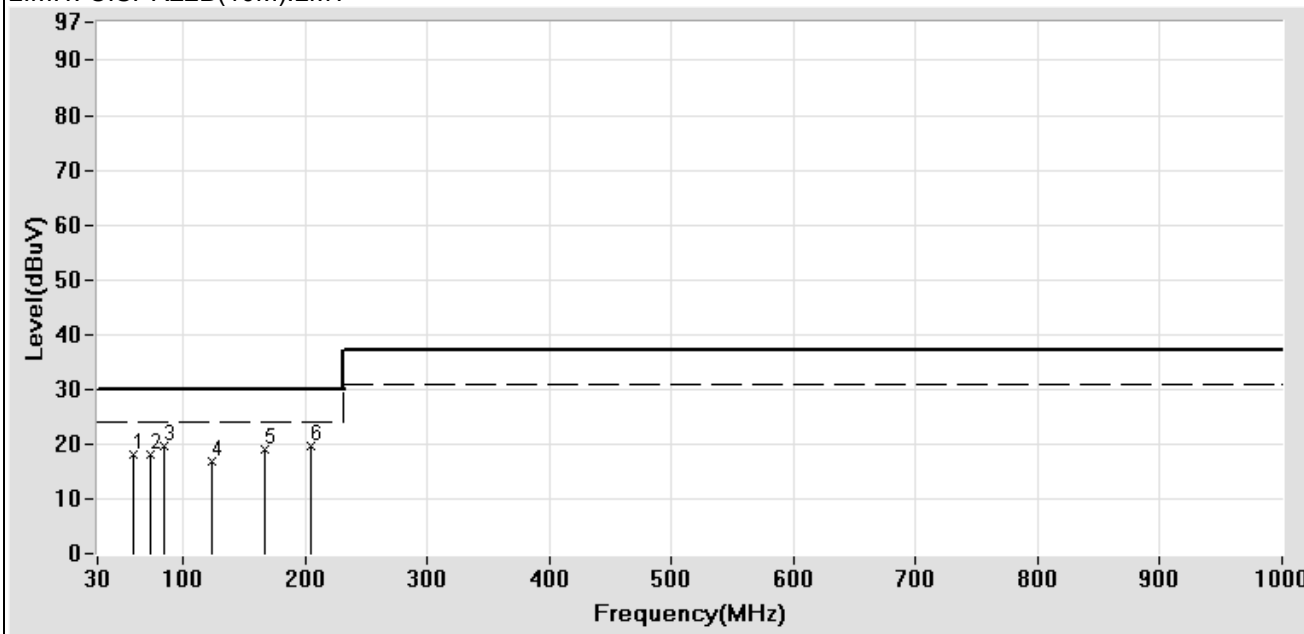

Test Mode: Mode 20: HALF LOAD (NSD10-12S12)

### Radiated Emission Measurement Data

EUT: Switching Power Supply CLIENT: MEAN WELL MODEL: NSD10-12S12 RATING: DC 12V Temperature: 18.0 °C Humidity: 79 %	POLARITY: Vertical DISTANCE: 10 m Serial No.: FILE/DATA#: MEAN WELL.emi/253 OPERATOR: Nigel TEST SITE: OATS1
--	---

Frequency	Factor	Meter Reading	Emission Level	Limits	Margin
(MHz)	(dB)	(dBµV)	(dBµV/m)	(dBµV/m)	(dB)
46.905 **	-16.42	39.56	23.14	30.00	-6.86
61.412 **	-20.50	40.56	20.06	30.00	-9.94
85.400 **	-19.91	38.34	18.43	30.00	-11.57
116.464 **	-15.63	35.87	20.24	30.00	-9.76
190.340 **	-11.01	31.45	20.44	30.00	-9.56
209.194 **	-10.77	30.66	19.89	30.00	-10.11

**Remark:**

1. “\*” Mark means readings are Peak Values.
2. “\*\*” Mark means readings are Quasi-Peak values.
3. Factor = Antenna Factor + Cable Loss – Pre-amplifier.

LIMIT: CISPR22B(10M).LMT

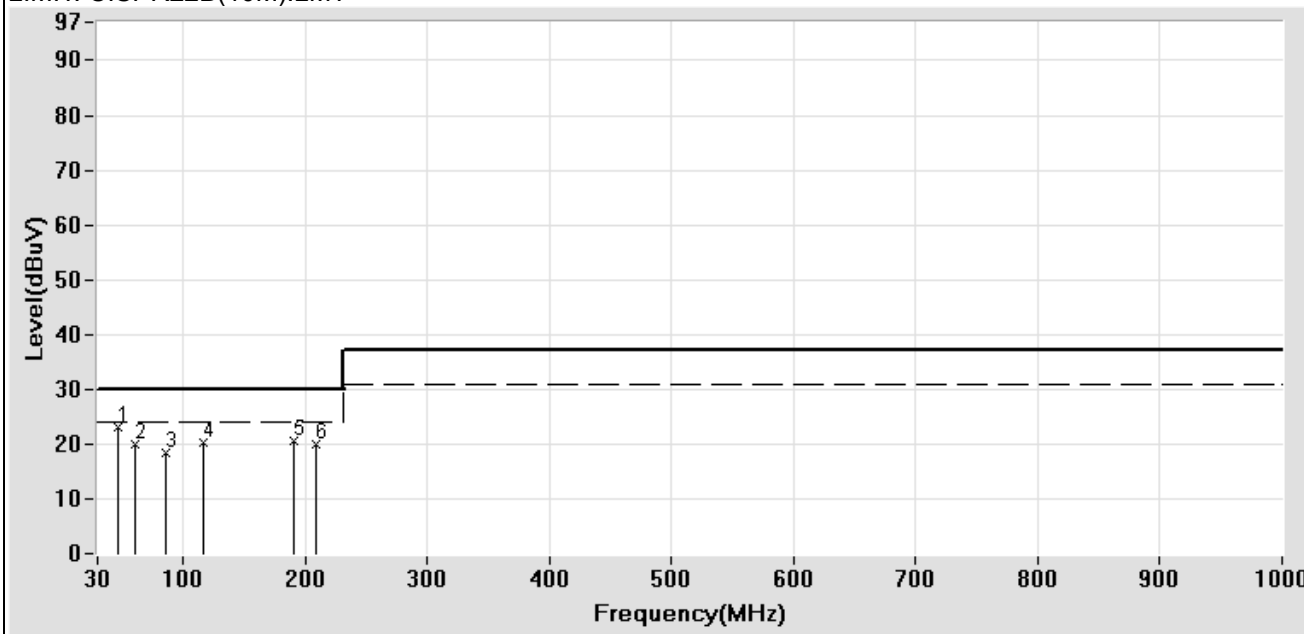

Test Mode: Mode 20: HALF LOAD (NSD10-12S12)

## Radiated Emission Measurement Data

EUT: Switching Power Supply CLIENT: MEAN WELL MODEL: NSD10-12S15 RATING: DC 12V Temperature: 14.0 °C Humidity: 57 %	POLARITY: Horizontal DISTANCE: 10 m Serial No.: FILE/DATA#: MEAN WELL.emi/60 OPERATOR: VICTOR TEST SITE: OATS1
--	---

Frequency	Factor	Meter Reading	Emission Level	Limits	Margin
(MHz)	(dB)	(dBμV)	(dBμV/m)	(dBμV/m)	(dB)
57.605 **	-19.03	35.58	16.55	30.00	-13.45
66.400 **	-21.47	36.03	14.56	30.00	-15.44
109.843 **	-15.78	36.70	20.92	30.00	-9.08
130.861 **	-13.42	34.27	20.85	30.00	-9.15
171.607 **	-11.31	30.62	19.31	30.00	-10.69
220.240 **	-9.99	32.47	22.48	30.00	-7.52

**Remark:**

1. “\*” Mark means readings are Peak Values.
2. “\*\*” Mark means readings are Quasi-Peak values.
3. Factor = Antenna Factor + Cable Loss – Pre-amplifier.

LIMIT: CISPR22B(10M).LMT

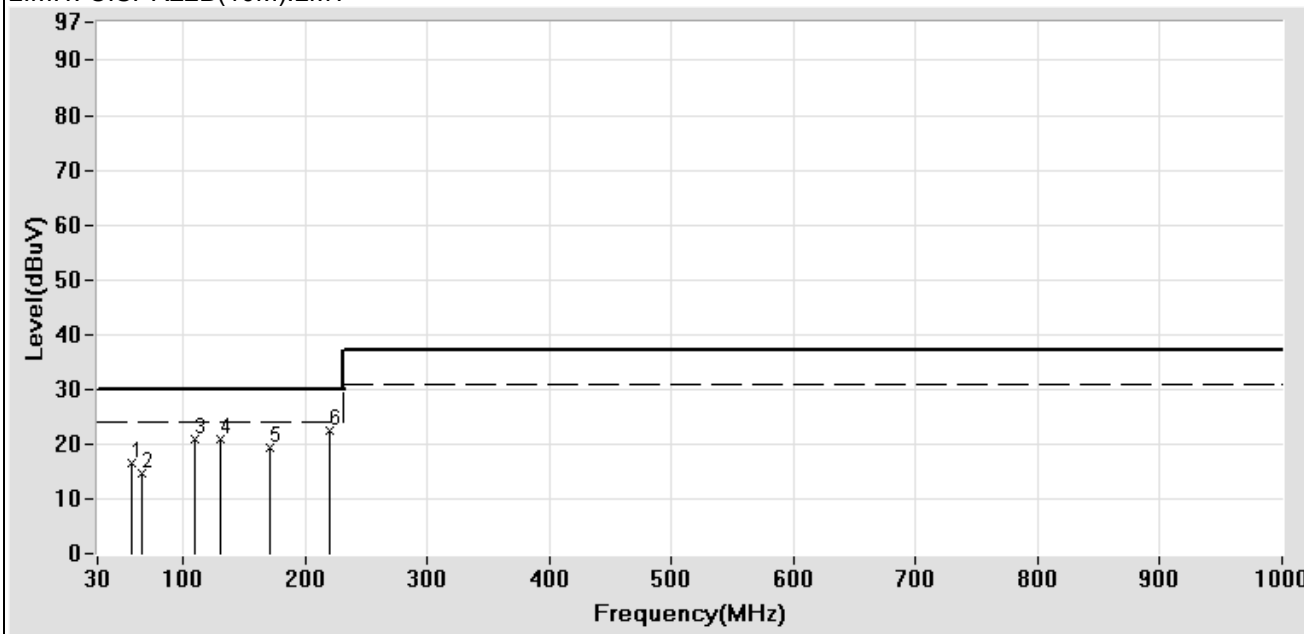

Test Mode: Mode 21: FULL LOAD (NSD10-12S15)

### Radiated Emission Measurement Data

EUT: Switching Power Supply	POLARITY: Vertical
CLIENT: MEAN WELL	DISTANCE: 10 m
MODEL: NSD10-12S15	Serial No.:
RATING: DC 12V	FILE/DATA#: MEAN WELL.emi/59
Temperature: 14.0 °C	OPERATOR: VICTOR
Humidity: 57 %	TEST SITE: OATS1

Frequency (MHz)	Factor (dB)	Meter Reading (dBµV)	Emission Level (dBµV/m)	Limits (dBµV/m)	Margin (dB)
50.446 **	-17.08	39.56	22.48	30.00	-7.52
60.613 **	-19.91	42.56	22.65	30.00	-7.35
67.124 **	-21.55	40.56	19.01	30.00	-10.99
110.765 **	-15.70	34.94	19.24	30.00	-10.76
176.769 **	-11.01	31.39	20.38	30.00	-9.62
206.613 **	-10.40	30.27	19.87	30.00	-10.13

**Remark:**

1. “\*” Mark means readings are Peak Values.
2. “\*\*” Mark means readings are Quasi-Peak values.
3. Factor = Antenna Factor + Cable Loss – Pre-amplifier.

LIMIT: CISPR22B(10M).LMT

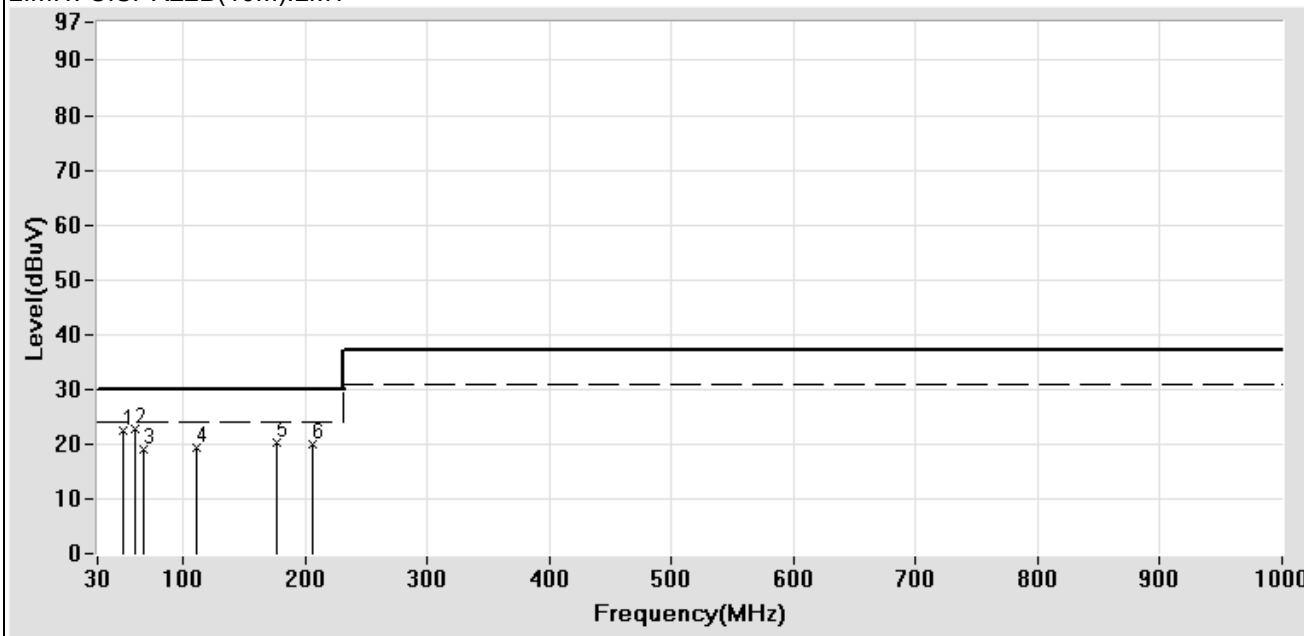

Test Mode: Mode 21: FULL LOAD (NSD10-12S15)



### Radiated Emission Measurement Data

EUT: Switching Power Supply CLIENT: MEAN WELL MODEL: NSD10-12S15 RATING: DC 12V Temperature: 18.0 °C Humidity: 79 %	POLARITY: Horizontal DISTANCE: 10 m Serial No.: FILE/DATA#: MEAN WELL.emi/264 OPERATOR: Nigel TEST SITE: OATS1
--	---

Frequency	Factor	Meter Reading	Emission Level	Limits	Margin
(MHz)	(dB)	(dBμV)	(dBμV/m)	(dBμV/m)	(dB)
56.501 **	-19.06	37.25	18.19	30.00	-11.81
72.949 **	-21.88	38.53	16.65	30.00	-13.35
85.515 **	-19.89	35.48	15.59	30.00	-14.41
117.619 **	-15.53	32.64	17.11	30.00	-12.89
164.176 **	-11.96	30.74	18.78	30.00	-11.22
208.040 **	-10.81	30.97	20.16	30.00	-9.84

Remark:

1. “\*” Mark means readings are Peak Values.
2. “\*\*” Mark means readings are Quasi-Peak values.
3. Factor = Antenna Factor + Cable Loss – Pre-amplifier.

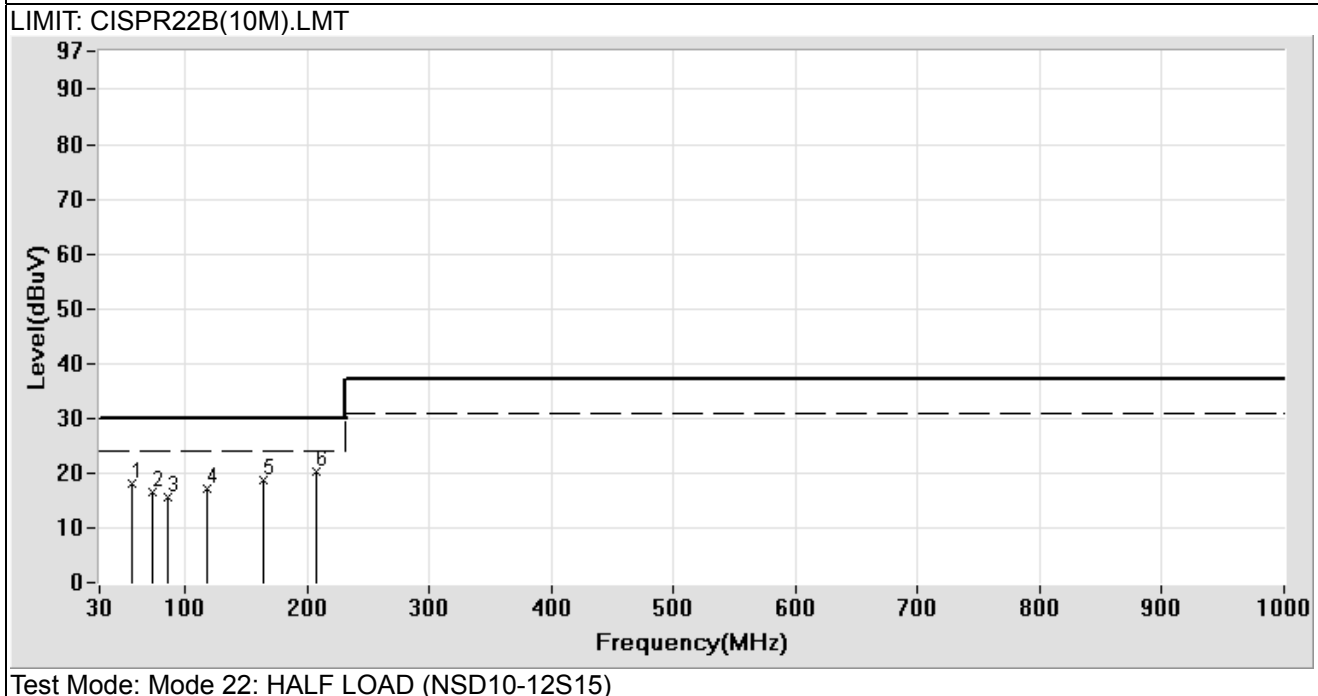

## Radiated Emission Measurement Data

EUT: Switching Power Supply CLIENT: MEAN WELL MODEL: NSD10-12S15 RATING: DC 12V Temperature: 18.0 °C Humidity: 79 %	POLARITY: Vertical DISTANCE: 10 m Serial No.: FILE/DATA#: MEAN WELL.emi/265 OPERATOR: Nigel TEST SITE: OATS1
--	---

Frequency	Factor	Meter Reading	Emission Level	Limits	Margin
(MHz)	(dB)	(dBμV)	(dBμV/m)	(dBμV/m)	(dB)
46.106 **	-16.21	38.56	22.35	30.00	-7.65
60.270 **	-20.14	39.96	19.82	30.00	-10.18
79.689 **	-20.51	38.56	18.05	30.00	-11.95
116.464 **	-15.63	34.99	19.36	30.00	-10.64
189.955 **	-11.01	33.56	22.55	30.00	-7.45
206.885 **	-10.84	31.05	20.21	30.00	-9.79

**Remark:**

1. “\*” Mark means readings are Peak Values.
2. “\*\*” Mark means readings are Quasi-Peak values.
3. Factor = Antenna Factor + Cable Loss – Pre-amplifier.

LIMIT: CISPR22B(10M).LMT

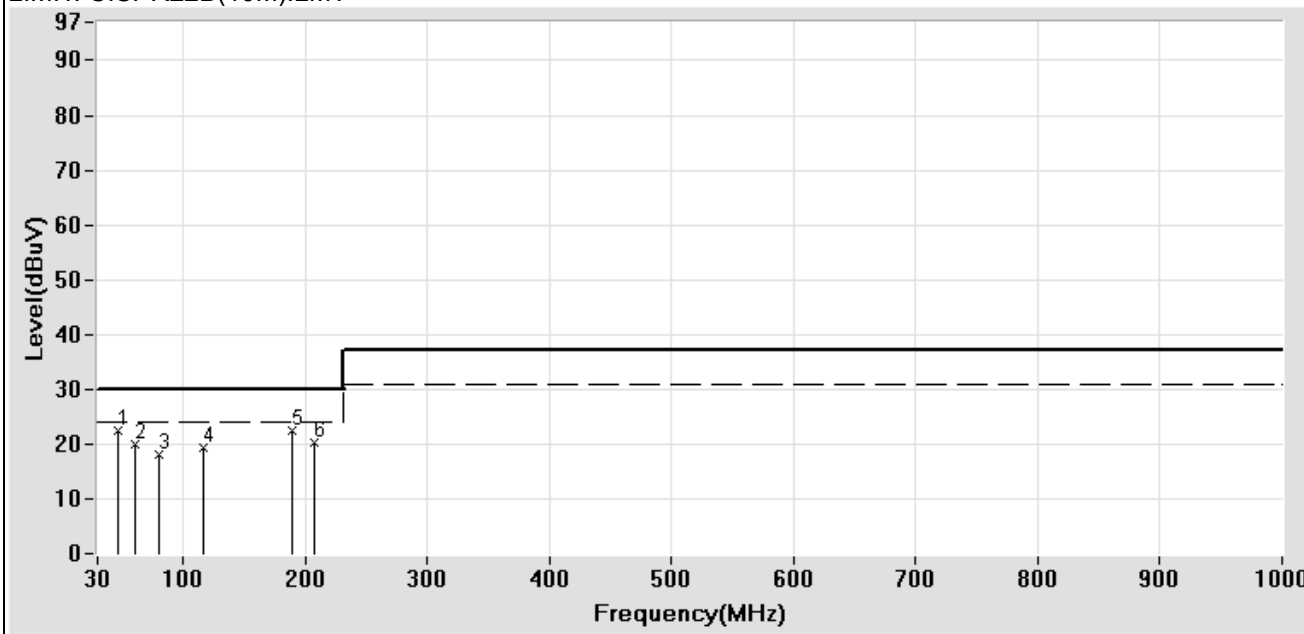

Test Mode: Mode 22: HALF LOAD (NSD10-12S15)

### Radiated Emission Measurement Data

EUT: Switching Power Supply CLIENT: MEAN WELL MODEL: NSD10-48S3 RATING: DC 48V Temperature: 14.0 °C Humidity: 57 %	POLARITY: Horizontal DISTANCE: 10 m Serial No.: FILE/DATA#: MEAN WELL.emi/153 OPERATOR: Nigel TEST SITE: OATS1
---	---

Frequency	Factor	Meter Reading	Emission Level	Limits	Margin
(MHz)	(dB)	(dBμV)	(dBμV/m)	(dBμV/m)	(dB)
58.671 **	-19.34	39.56	20.22	30.00	-9.78
71.693 **	-21.67	42.16	20.49	30.00	-9.51
84.943 **	-19.57	40.26	20.69	30.00	-9.31
114.268 **	-15.42	34.86	19.44	30.00	-10.56
123.118 **	-14.50	34.16	19.66	30.00	-10.34
250.621 **	-9.29	35.54	26.25	37.00	-10.75

**Remark:**

1. “\*” Mark means readings are Peak Values.
2. “\*\*” Mark means readings are Quasi-Peak values.
3. Factor = Antenna Factor + Cable Loss – Pre-amplifier.

LIMIT: CISPR22B(10M).LMT

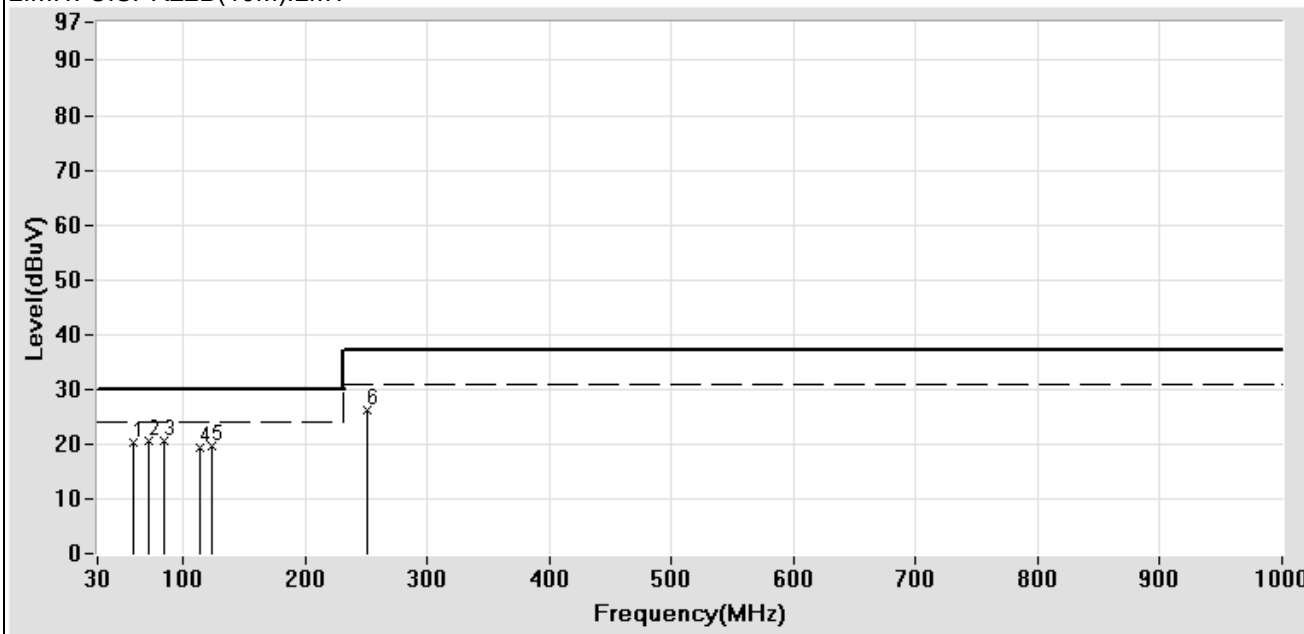

Test Mode: Mode 23: FULL LOAD (NSD10-48S3)

### Radiated Emission Measurement Data

EUT: Switching Power Supply CLIENT: MEAN WELL MODEL: NSD10-48S3 RATING: DC 48V Temperature: 14.0 °C Humidity: 57 %	POLARITY: Vertical DISTANCE: 10 m Serial No.: FILE/DATA#: MEAN WELL.emi/152 OPERATOR: Nigel TEST SITE: OATS1
---	---

Frequency	Factor	Meter Reading	Emission Level	Limits	Margin
(MHz)	(dB)	(dBμV)	(dBμV/m)	(dBμV/m)	(dB)
51.132 **	-17.26	37.89	20.63	30.00	-9.37
60.042 **	-19.72	41.56	21.84	30.00	-8.16
68.494 **	-21.71	43.56	21.85	30.00	-8.15
110.765 **	-15.70	36.91	21.21	30.00	-8.79
124.408 **	-14.30	32.65	18.35	30.00	-11.65
207.014 **	-10.38	30.79	20.41	30.00	-9.59
241.082 **	-9.56	34.40	24.84	37.00	-12.16

Remark:

1. " \* " Mark means readings are Peak Values.
2. " \*\* " Mark means readings are Quasi-Peak values.
3. Factor = Antenna Factor + Cable Loss – Pre-amplifier.

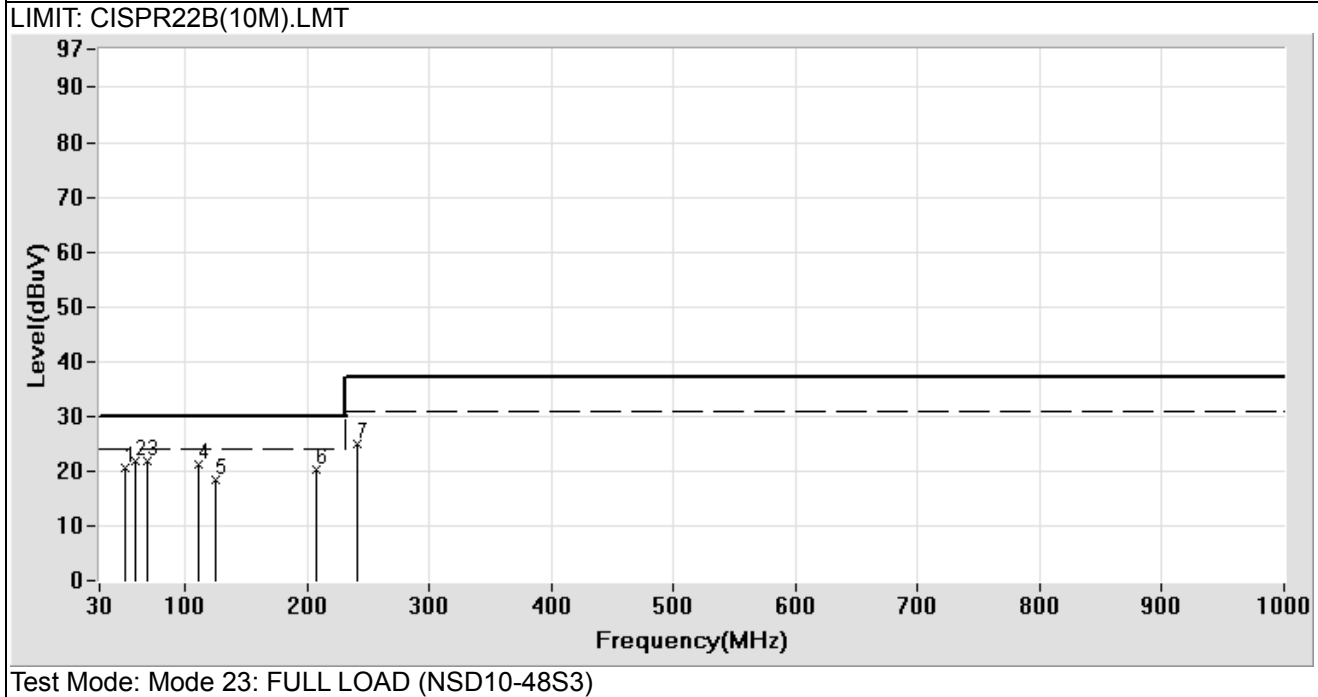

## Radiated Emission Measurement Data

EUT: Switching Power Supply CLIENT: MEAN WELL MODEL: NSD10-48S3 RATING: DC 48V Temperature: 18.0 °C Humidity: 79 %	POLARITY: Horizontal DISTANCE: 10 m Serial No.: FILE/DATA#: MEAN WELL.emi/259 OPERATOR: Nigel TEST SITE: OATS1
---	---

Frequency	Factor	Meter Reading	Emission Level	Limits	Margin
(MHz)	(dB)	(dBμV)	(dBμV/m)	(dBμV/m)	(dB)
56.957 **	-19.19	37.89	18.70	30.00	-11.30
67.352 **	-21.94	39.35	17.41	30.00	-12.59
85.857 **	-19.85	38.56	18.71	30.00	-11.29
114.925 **	-15.75	33.93	18.18	30.00	-11.82
162.637 **	-12.01	30.14	18.13	30.00	-11.87
208.424 **	-10.80	30.03	19.23	30.00	-10.77

**Remark:**

1. “\*” Mark means readings are Peak Values.
2. “\*\*” Mark means readings are Quasi-Peak values.
3. Factor = Antenna Factor + Cable Loss – Pre-amplifier.

LIMIT: CISPR22B(10M).LMT

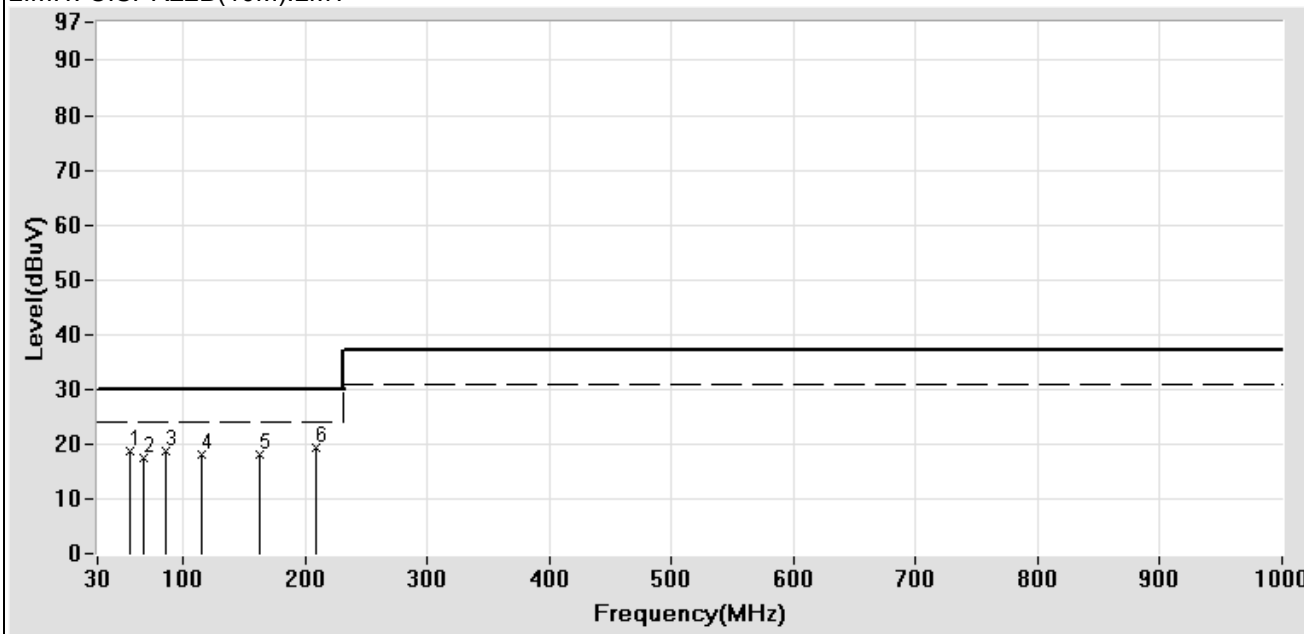

Test Mode: Mode 24: HALF LOAD (NSD10-48S3)

### Radiated Emission Measurement Data

EUT: Switching Power Supply CLIENT: MEAN WELL MODEL: NSD10-48S3 RATING: DC 48V Temperature: 18.0 °C Humidity: 79 %	POLARITY: Vertical DISTANCE: 10 m Serial No.: FILE/DATA#: MEAN WELL.emi/258 OPERATOR: Nigel TEST SITE: OATS1
---	---

Frequency	Factor	Meter Reading	Emission Level	Limits	Margin
(MHz)	(dB)	(dBμV)	(dBμV/m)	(dBμV/m)	(dB)
46.677 **	-16.37	39.56	23.19	30.00	-6.81
60.498 **	-20.21	40.41	20.20	30.00	-9.80
120.312 **	-15.30	35.66	20.36	30.00	-9.64
156.096 **	-12.33	31.41	19.08	30.00	-10.92
189.186 **	-11.02	33.38	22.36	30.00	-7.64
208.809 **	-10.79	31.19	20.40	30.00	-9.60

**Remark:**

1. “\*” Mark means readings are Peak Values.
2. “\*\*” Mark means readings are Quasi-Peak values.
3. Factor = Antenna Factor + Cable Loss – Pre-amplifier.

LIMIT: CISPR22B(10M).LMT

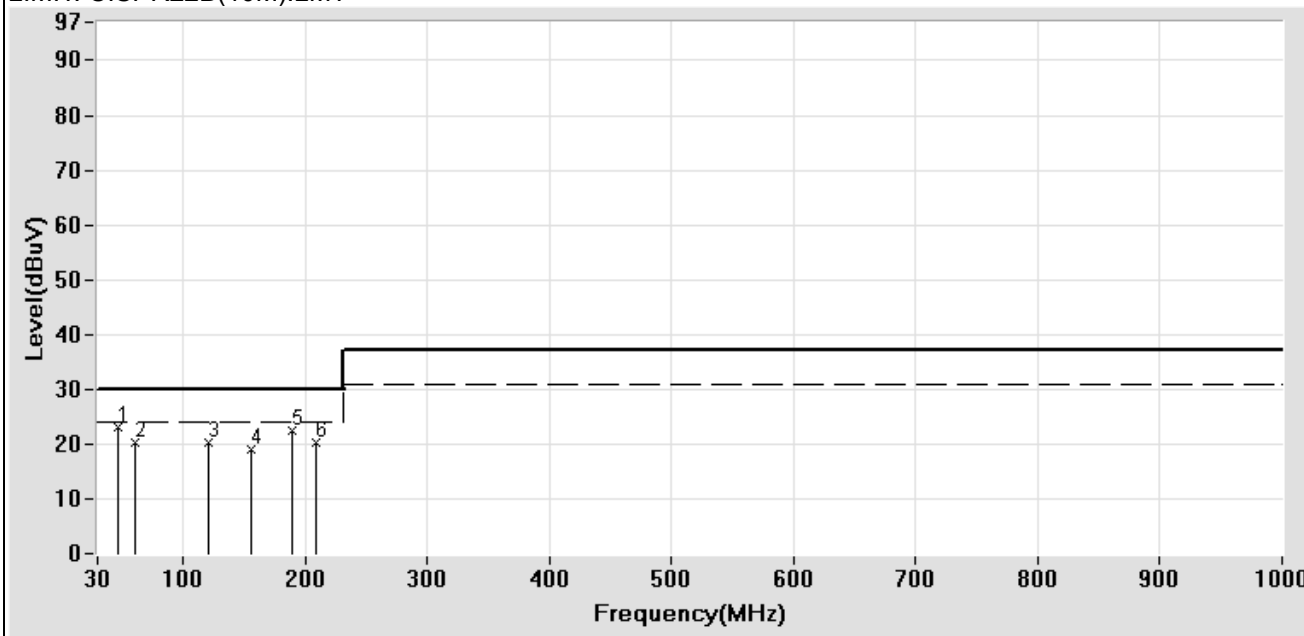

Test Mode: Mode 24: HALF LOAD (NSD10-48S3)

### Radiated Emission Measurement Data

EUT: Switching Power Supply CLIENT: MEAN WELL MODEL: NSD10-48S5 RATING: DC 48V Temperature: 14.0 °C Humidity: 57 %	POLARITY: Horizontal DISTANCE: 10 m Serial No.: FILE/DATA#: MEAN WELL.emi/145 OPERATOR: Nigel TEST SITE: OATS1
---	---

Frequency	Factor	Meter Reading	Emission Level	Limits	Margin
(MHz)	(dB)	(dBμV)	(dBμV/m)	(dBμV/m)	(dB)
58.378 **	-19.25	39.61	20.36	30.00	-9.64
65.867 **	-21.40	42.56	21.16	30.00	-8.84
84.601 **	-19.60	38.11	18.51	30.00	-11.49
113.531 **	-15.48	36.17	20.69	30.00	-9.31
125.883 **	-14.09	35.46	21.37	30.00	-8.63
206.613 **	-10.40	30.75	20.35	30.00	-9.65

**Remark:**

1. “ \* ” Mark means readings are Peak Values.
2. “ \*\* ” Mark means readings are Quasi-Peak values.
3. Factor = Antenna Factor + Cable Loss – Pre-amplifier.

LIMIT: CISPR22B(10M).LMT

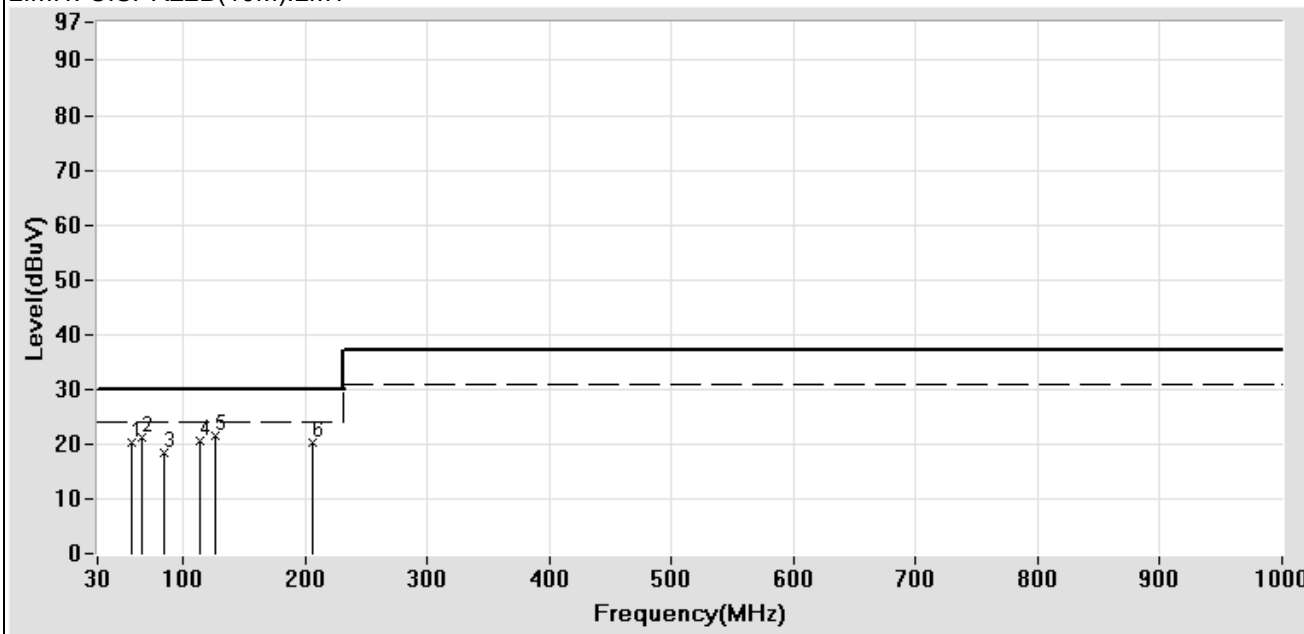

Test Mode: Mode 25: FULL LOAD (NSD10-48S5)

## Radiated Emission Measurement Data

EUT: Switching Power Supply CLIENT: MEAN WELL MODEL: NSD10-48S5 RATING: DC 48V Temperature: 14.0 °C Humidity: 57 %	POLARITY: Vertical DISTANCE: 10 m Serial No.: FILE/DATA#: MEAN WELL.emi/147 OPERATOR: Nigel TEST SITE: OATS1
---	---

Frequency	Factor	Meter Reading	Emission Level	Limits	Margin
(MHz)	(dB)	(dBμV)	(dBμV/m)	(dBμV/m)	(dB)
55.929 **	-18.56	39.12	20.56	30.00	-9.44
60.316 **	-19.82	40.78	20.96	30.00	-9.04
83.687 **	-19.70	39.56	19.86	30.00	-10.14
112.056 **	-15.60	37.28	21.68	30.00	-8.32
122.565 **	-14.58	34.09	19.51	30.00	-10.49
205.811 **	-10.41	30.45	20.04	30.00	-9.96

Remark:

1. “\*” Mark means readings are Peak Values.
2. “\*\*” Mark means readings are Quasi-Peak values.
3. Factor = Antenna Factor + Cable Loss – Pre-amplifier.

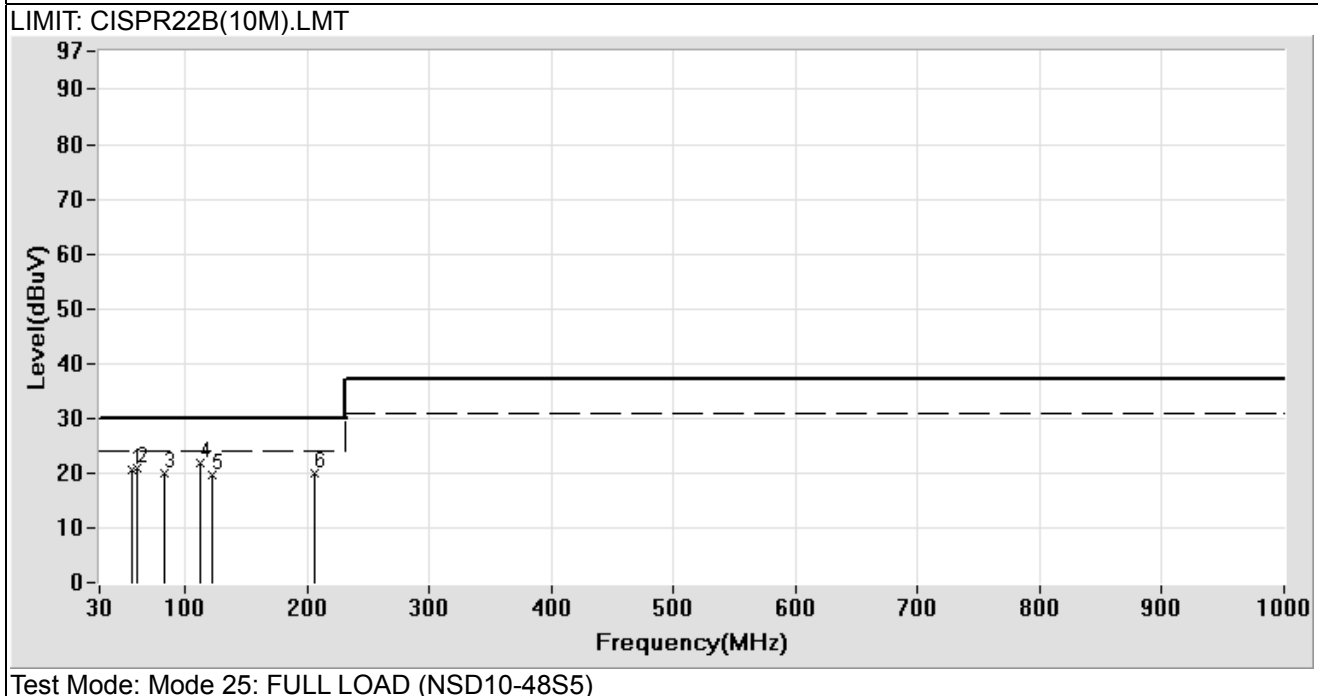



### Radiated Emission Measurement Data

EUT: Switching Power Supply CLIENT: MEAN WELL MODEL: NSD10-48S5 RATING: DC 48V Temperature: 18.0 °C Humidity: 79 %	POLARITY: Horizontal DISTANCE: 10 m Serial No.: FILE/DATA#: MEAN WELL.emi/268 OPERATOR: Nigel TEST SITE: OATS1
---	---

Frequency	Factor	Meter Reading	Emission Level	Limits	Margin
(MHz)	(dB)	(dBμV)	(dBμV/m)	(dBμV/m)	(dB)
57.414 **	-19.32	37.89	18.57	30.00	-11.43
63.811 **	-21.28	37.21	15.93	30.00	-14.07
85.515 **	-19.89	37.89	18.00	30.00	-12.00
113.386 **	-15.87	34.30	18.43	30.00	-11.57
194.957 **	-11.02	31.45	20.43	30.00	-9.57
226.893 **	-10.28	32.56	22.28	30.00	-7.72

**Remark:**

1. “\*” Mark means readings are Peak Values.
2. “\*\*” Mark means readings are Quasi-Peak values.
3. Factor = Antenna Factor + Cable Loss – Pre-amplifier.

LIMIT: CISPR22B(10M).LMT

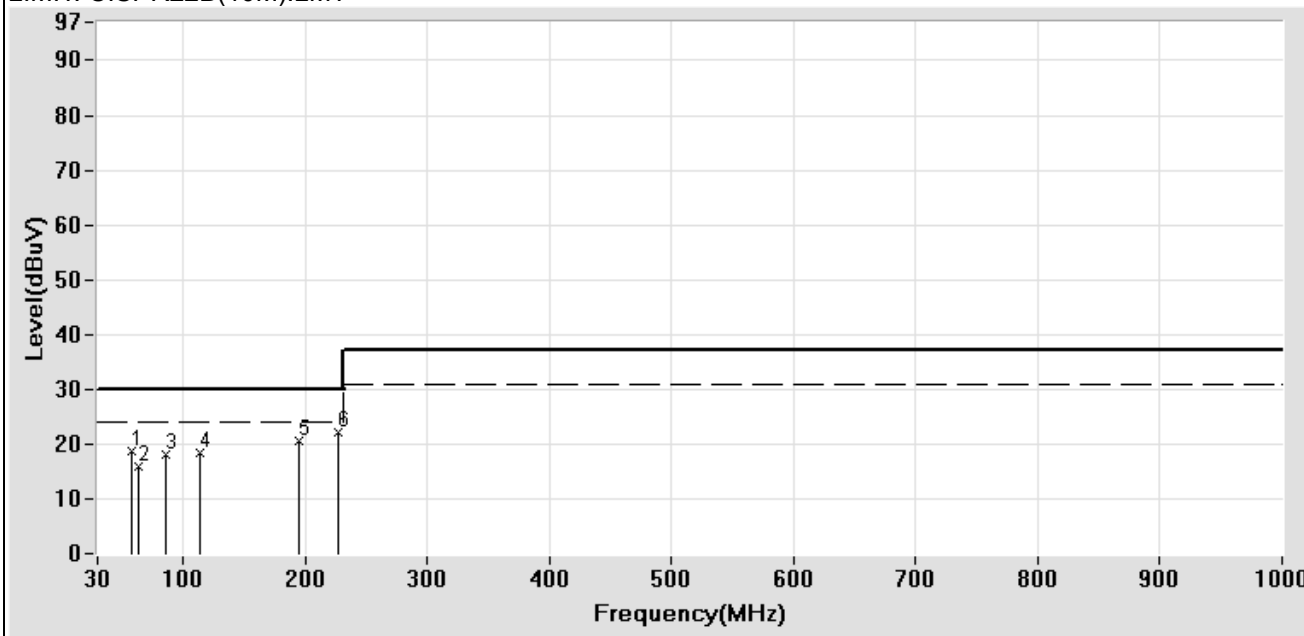

Test Mode: Mode 26: HALF LOAD (NSD10-48S5)

### Radiated Emission Measurement Data

EUT: Switching Power Supply CLIENT: MEAN WELL MODEL: NSD10-48S5 RATING: DC 48V Temperature: 18.0 °C Humidity: 79 %	POLARITY: Vertical DISTANCE: 10 m Serial No.: FILE/DATA#: MEAN WELL.emi/269 OPERATOR: Nigel TEST SITE: OATS1
---	---

Frequency	Factor	Meter Reading	Emission Level	Limits	Margin
(MHz)	(dB)	(dBμV)	(dBμV/m)	(dBμV/m)	(dB)
45.306 **	-15.99	38.56	22.57	30.00	-7.43
61.070 **	-20.39	39.94	19.55	30.00	-10.45
84.144 **	-20.04	37.34	17.30	30.00	-12.70
119.158 **	-15.40	35.10	19.70	30.00	-10.30
184.569 **	-11.16	32.56	21.40	30.00	-8.60
206.116 **	-10.86	32.28	21.42	30.00	-8.58

**Remark:**

1. “ \* ” Mark means readings are Peak Values.
2. “ \*\* ” Mark means readings are Quasi-Peak values.
3. Factor = Antenna Factor + Cable Loss – Pre-amplifier.

LIMIT: CISPR22B(10M).LMT

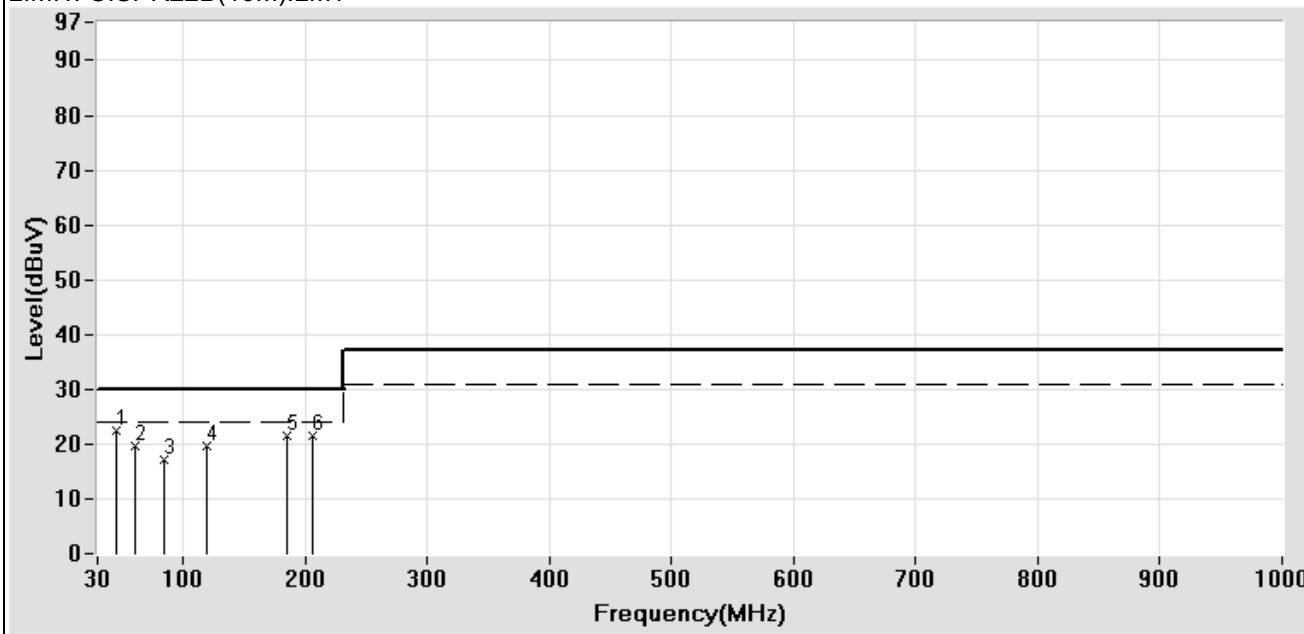

Test Mode: Mode 26: HALF LOAD (NSD10-48S5)

## Radiated Emission Measurement Data

EUT: Switching Power Supply CLIENT: MEAN WELL MODEL: NSD10-48S9 RATING: DC 48V Temperature: 14.0 °C Humidity: 57 %	POLARITY: Horizontal DISTANCE: 10 m Serial No.: FILE/DATA#: MEAN WELL.emi/159 OPERATOR: Nigel TEST SITE: OATS1
---	---

Frequency (MHz)	Factor (dB)	Meter Reading (dBμV)	Emission Level (dBμV/m)	Limits (dBμV/m)	Margin (dB)
56.158 **	-18.62	40.12	21.50	30.00	-8.50
67.923 **	-21.65	41.23	19.58	30.00	-10.42
85.058 **	-19.56	38.59	19.03	30.00	-10.97
117.218 **	-15.18	33.62	18.44	30.00	-11.56
196.865 **	-10.57	34.75	24.18	30.00	-5.82
223.847 **	-9.89	33.03	23.14	30.00	-6.86
248.897 **	-9.33	36.87	27.54	37.00	-9.46

**Remark:**

1. " \* " Mark means readings are Peak Values.
2. " \*\* " Mark means readings are Quasi-Peak values.
3. Factor = Antenna Factor + Cable Loss – Pre-amplifier.

LIMIT: CISPR22B(10M).LMT

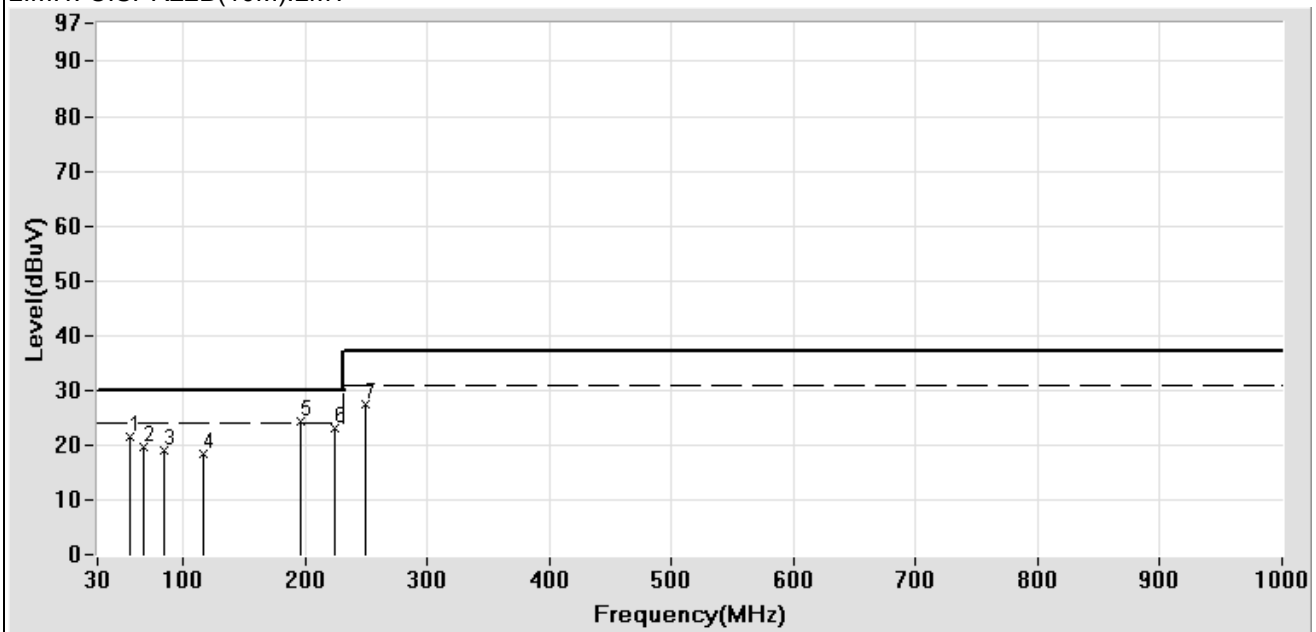

Test Mode: Mode 27: FULL LOAD (NSD10-48S9)

## Radiated Emission Measurement Data

EUT: Switching Power Supply CLIENT: MEAN WELL MODEL: NSD10-48S9 RATING: DC 48V Temperature: 14.0 °C Humidity: 57 %	POLARITY: Vertical DISTANCE: 10 m Serial No.: FILE/DATA#: MEAN WELL.emi/158 OPERATOR: Nigel TEST SITE: OATS1
---	---

Frequency	Factor	Meter Reading	Emission Level	Limits	Margin
(MHz)	(dB)	(dBμV)	(dBμV/m)	(dBμV/m)	(dB)
49.304 **	-16.77	38.89	22.12	30.00	-7.88
60.498 **	-19.87	41.89	22.02	30.00	-7.98
83.230 **	-19.74	41.28	21.54	30.00	-8.46
110.581 **	-15.72	36.90	21.18	30.00	-8.82
197.971 **	-10.57	31.13	20.56	30.00	-9.44
207.014 **	-10.38	33.06	22.68	30.00	-7.32

**Remark:**

1. “\*” Mark means readings are Peak Values.
2. “\*\*” Mark means readings are Quasi-Peak values.
3. Factor = Antenna Factor + Cable Loss – Pre-amplifier.

LIMIT: CISPR22B(10M).LMT

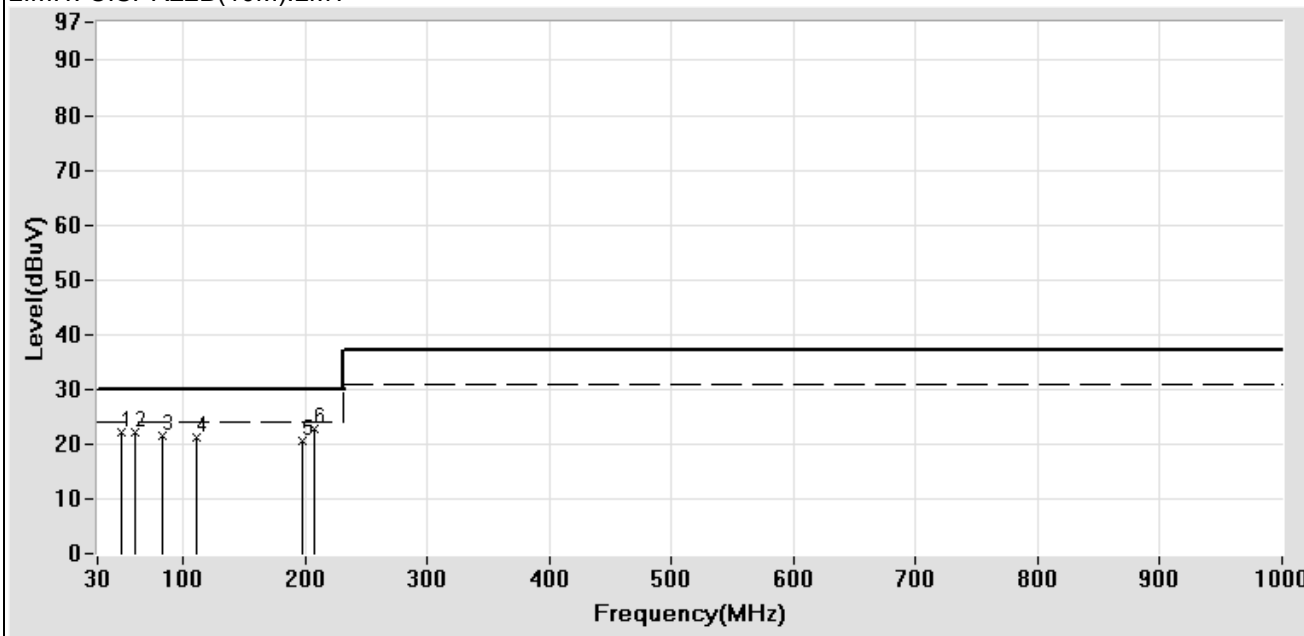

Test Mode: Mode 27: FULL LOAD (NSD10-48S9)

### Radiated Emission Measurement Data

EUT: Switching Power Supply CLIENT: MEAN WELL MODEL: NSD10-48S9 RATING: DC 48V Temperature: 18.0 °C Humidity: 79 %	POLARITY: Horizontal DISTANCE: 10 m Serial No.: FILE/DATA#: MEAN WELL.emi/271 OPERATOR: Nigel TEST SITE: OATS1
---	---

Frequency	Factor	Meter Reading	Emission Level	Limits	Margin
(MHz)	(dB)	(dBμV)	(dBμV/m)	(dBμV/m)	(dB)
59.128 **	-19.81	37.58	17.77	30.00	-12.23
73.178 **	-21.86	39.56	17.70	30.00	-12.30
85.058 **	-19.94	37.72	17.78	30.00	-12.22
115.310 **	-15.71	33.85	18.14	30.00	-11.86
183.030 **	-11.19	31.88	20.69	30.00	-9.31
208.809 **	-10.79	30.52	19.73	30.00	-10.27

**Remark:**

1. “\*” Mark means readings are Peak Values.
2. “\*\*” Mark means readings are Quasi-Peak values.
3. Factor = Antenna Factor + Cable Loss – Pre-amplifier.

LIMIT: CISPR22B(10M).LMT

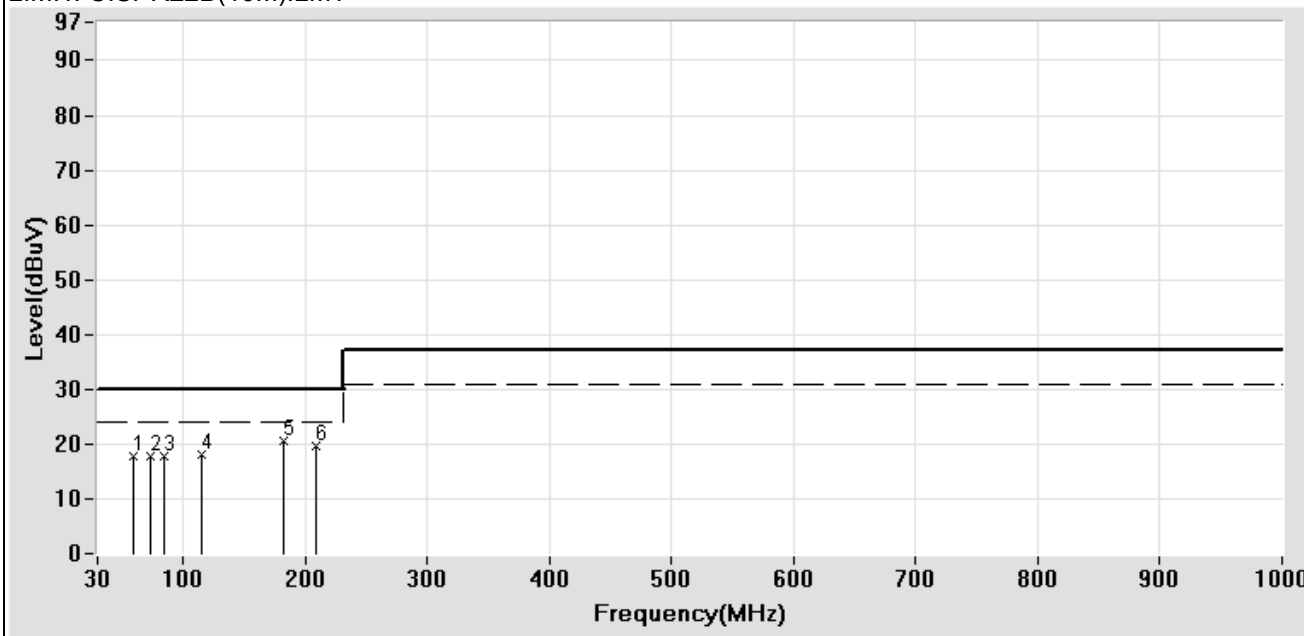

Test Mode: Mode 28: HALF LOAD (NSD10-48S9)

### Radiated Emission Measurement Data

EUT: Switching Power Supply CLIENT: MEAN WELL MODEL: NSD10-48S9 RATING: DC 48V Temperature: 18.0 °C Humidity: 79 %	POLARITY: Vertical DISTANCE: 10 m Serial No.: FILE/DATA#: MEAN WELL.emi/270 OPERATOR: Nigel TEST SITE: OATS1
---	---

Frequency	Factor	Meter Reading	Emission Level	Limits	Margin
(MHz)	(dB)	(dBμV)	(dBμV/m)	(dBμV/m)	(dB)
45.306 **	-15.99	38.55	22.56	30.00	-7.44
60.384 **	-20.18	40.52	20.34	30.00	-9.66
84.372 **	-20.01	38.56	18.55	30.00	-11.45
116.849 **	-15.60	35.32	19.72	30.00	-10.28
196.881 **	-11.03	32.56	21.53	30.00	-8.47
216.120 **	-10.56	32.32	21.76	30.00	-8.24

**Remark:**

1. “ \* ” Mark means readings are Peak Values.
2. “ \*\* ” Mark means readings are Quasi-Peak values.
3. Factor = Antenna Factor + Cable Loss – Pre-amplifier.

LIMIT: CISPR22B(10M).LMT

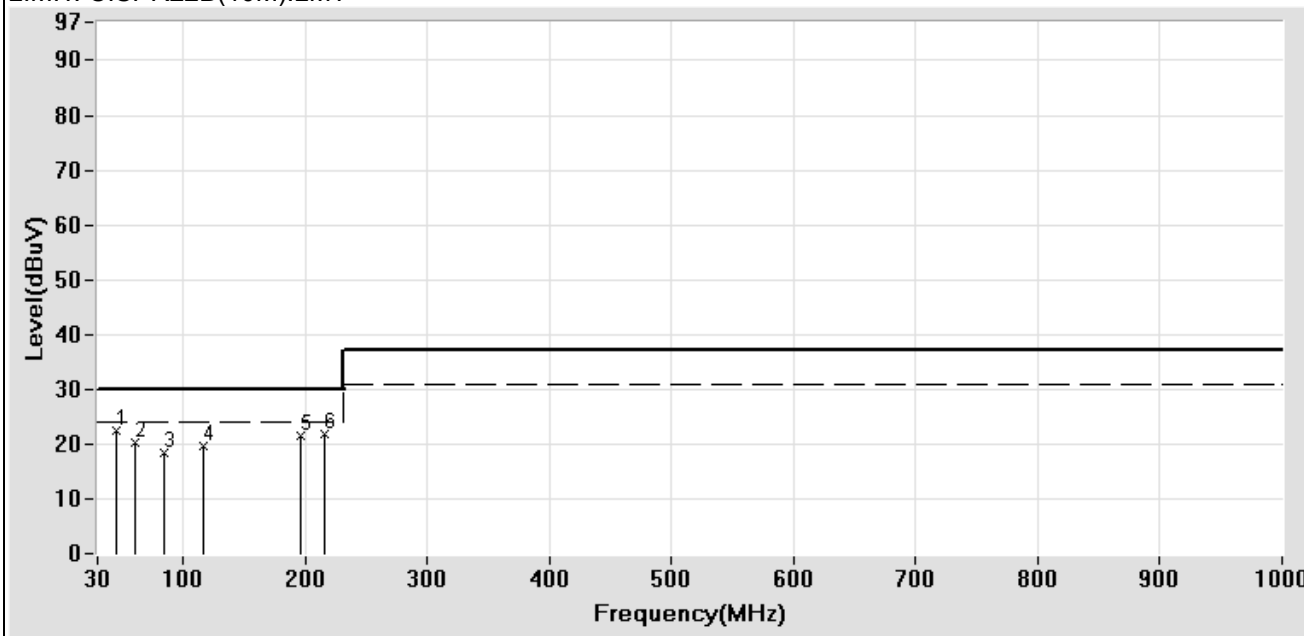

Test Mode: Mode 28: HALF LOAD (NSD10-48S9)

### Radiated Emission Measurement Data

EUT: Switching Power Supply CLIENT: MEAN WELL MODEL: NSD10-48S12 RATING: DC 48V Temperature: 16.0 °C Humidity: 56 %	POLARITY: Horizontal DISTANCE: 10 m Serial No.: FILE/DATA#: MEAN WELL.emi/1869 OPERATOR: Nigel TEST SITE: OATS1
--	--

Frequency	Factor	Meter Reading	Emission Level	Limits	Margin
(MHz)	(dB)	(dBμV)	(dBμV/m)	(dBμV/m)	(dB)
59.242 **	-20.97	37.45	16.48	30.00	-13.52
72.150 **	-23.17	39.87	16.70	30.00	-13.30
84.030 **	-21.40	41.83	20.43	30.00	-9.57
117.587 **	-16.97	34.69	17.72	30.00	-12.28
163.310 **	-13.35	32.94	19.59	30.00	-10.41
220.641 **	-12.04	31.81	19.77	30.00	-10.23

**Remark:**

1. “\*” Mark means readings are Peak Values.
2. “\*\*” Mark means readings are Quasi-Peak values.
3. Factor = Antenna Factor + Cable Loss – Pre-amplifier.

LIMIT: CISPR22B(10M).LMT

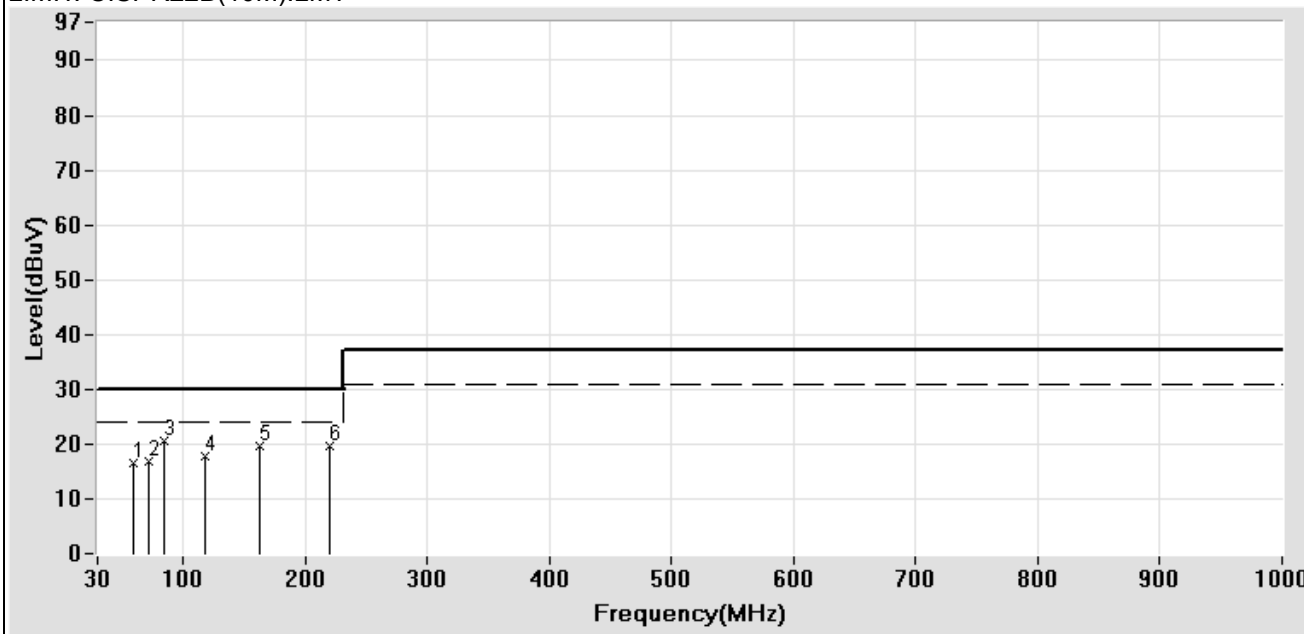

Test Mode: Mode 29: FULL LOAD (NSD10-48S12)

### Radiated Emission Measurement Data

EUT: Switching Power Supply CLIENT: MEAN WELL MODEL: NSD10-48S12 RATING: DC 48V Temperature: 16.0 °C Humidity: 56 %	POLARITY: Vertical DISTANCE: 10 m Serial No.: FILE/DATA#: MEAN WELL.emi/1868 OPERATOR: Nigel TEST SITE: OATS1
--	--

Frequency	Factor	Meter Reading	Emission Level	Limits	Margin
(MHz)	(dB)	(dBμV)	(dBμV/m)	(dBμV/m)	(dB)
50.561 **	-18.49	40.87	22.38	30.00	-7.62
59.927 **	-21.16	43.43	22.27	30.00	-7.73
83.915 **	-21.41	41.67	20.26	30.00	-9.74
111.503 **	-17.44	39.87	22.43	30.00	-7.57
125.146 **	-15.99	35.72	19.73	30.00	-10.27
208.416 **	-12.36	34.56	22.20	30.00	-7.80

**Remark:**

1. “\*” Mark means readings are Peak Values.
2. “\*\*” Mark means readings are Quasi-Peak values.
3. Factor = Antenna Factor + Cable Loss – Pre-amplifier.

LIMIT: CISPR22B(10M).LMT

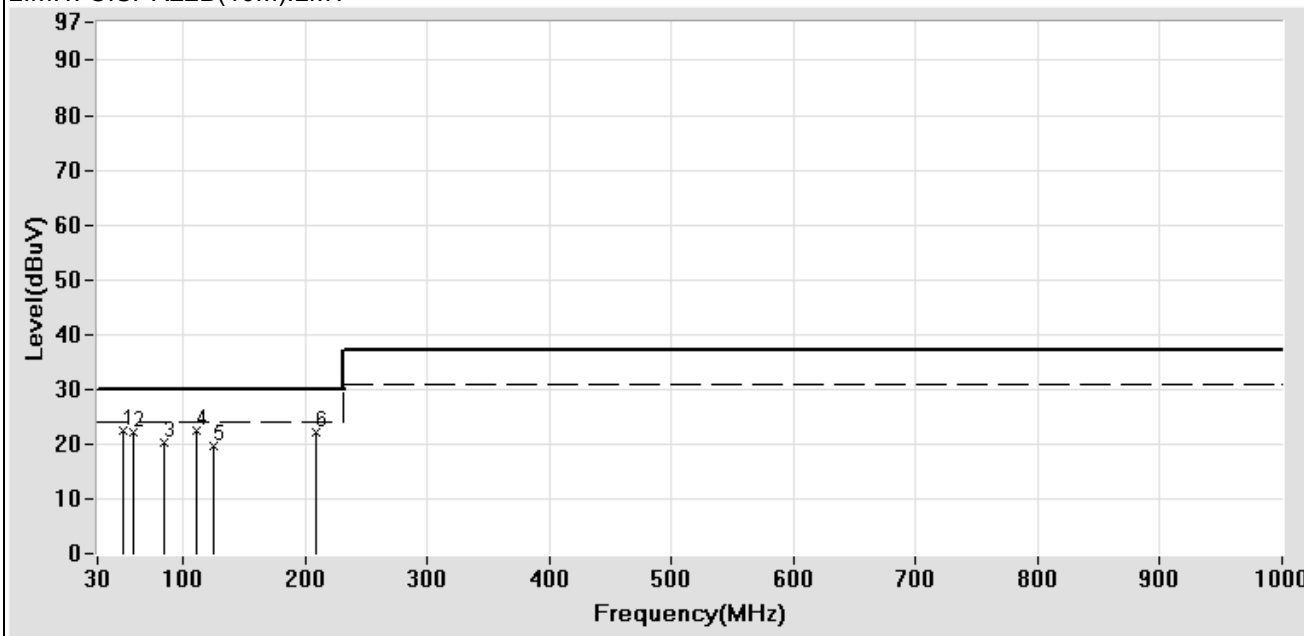

Test Mode: Mode 29: FULL LOAD (NSD10-48S12)



### Radiated Emission Measurement Data

EUT: Switching Power Supply CLIENT: MEAN WELL MODEL: NSD10-48S12 RATING: DC 48V Temperature: 18.0 °C Humidity: 79 %	POLARITY: Horizontal DISTANCE: 10 m Serial No.: FILE/DATA#: MEAN WELL.emi/275 OPERATOR: Nigel TEST SITE: OATS1
--	---

Frequency	Factor	Meter Reading	Emission Level	Limits	Margin
(MHz)	(dB)	(dBμV)	(dBμV/m)	(dBμV/m)	(dB)
57.186 **	-19.26	38.05	18.79	30.00	-11.21
63.925 **	-21.31	39.15	17.84	30.00	-12.16
85.286 **	-19.92	37.89	17.97	30.00	-12.03
118.004 **	-15.50	33.24	17.74	30.00	-12.26
165.715 **	-11.92	31.08	19.16	30.00	-10.84
229.587 **	-10.21	30.66	20.45	30.00	-9.55

**Remark:**

1. “\*” Mark means readings are Peak Values.
2. “\*\*” Mark means readings are Quasi-Peak values.
3. Factor = Antenna Factor + Cable Loss – Pre-amplifier.

LIMIT: CISPR22B(10M).LMT

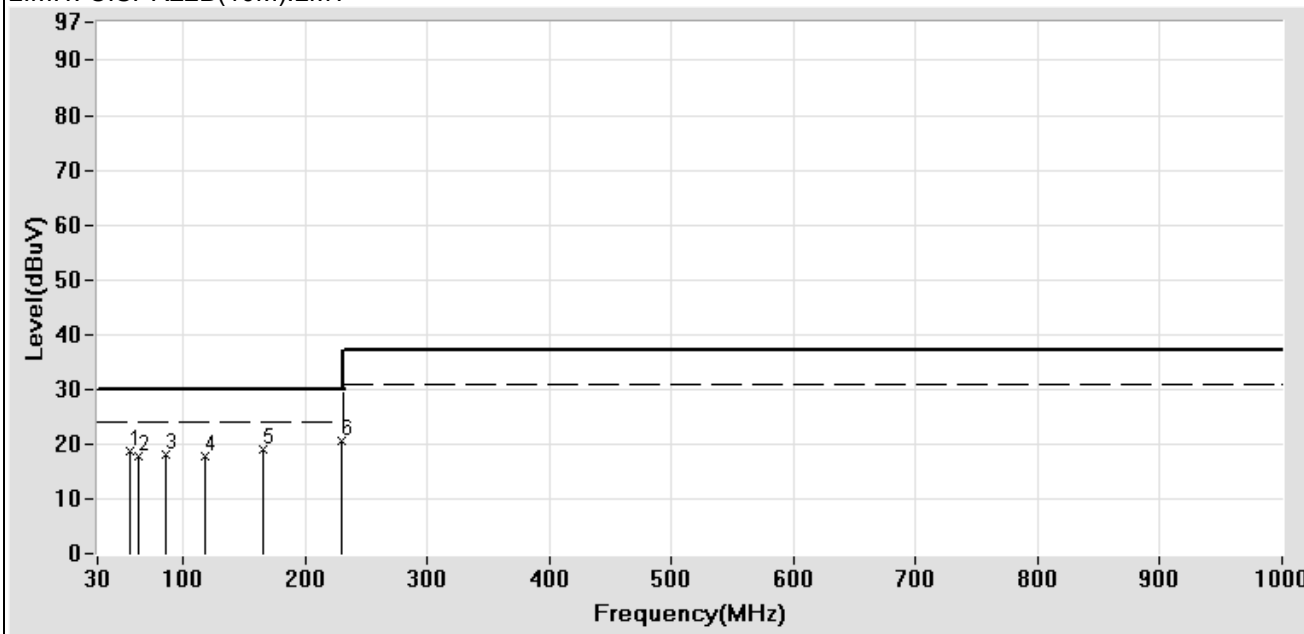

Test Mode: Mode 30: HALF LOAD (NSD10-48S12)

## Radiated Emission Measurement Data

EUT: Switching Power Supply CLIENT: MEAN WELL MODEL: NSD10-48S12 RATING: DC 48V Temperature: 18.0 °C Humidity: 79 %	POLARITY: Vertical DISTANCE: 10 m Serial No.: FILE/DATA#: MEAN WELL.emi/274 OPERATOR: Nigel TEST SITE: OATS1
--	---

Frequency	Factor	Meter Reading	Emission Level	Limits	Margin
(MHz)	(dB)	(dBμV)	(dBμV/m)	(dBμV/m)	(dB)
43.935 **	-15.54	39.56	24.02	30.00	-5.98
60.270 **	-20.14	40.26	20.12	30.00	-9.88
80.032 **	-20.44	40.83	20.39	30.00	-9.61
118.773 **	-15.44	35.25	19.81	30.00	-10.19
196.496 **	-11.02	33.49	22.47	30.00	-7.53
208.809 **	-10.79	31.71	20.92	30.00	-9.08

**Remark:**

1. “\*” Mark means readings are Peak Values.
2. “\*\*” Mark means readings are Quasi-Peak values.
3. Factor = Antenna Factor + Cable Loss – Pre-amplifier.

LIMIT: CISPR22B(10M).LMT

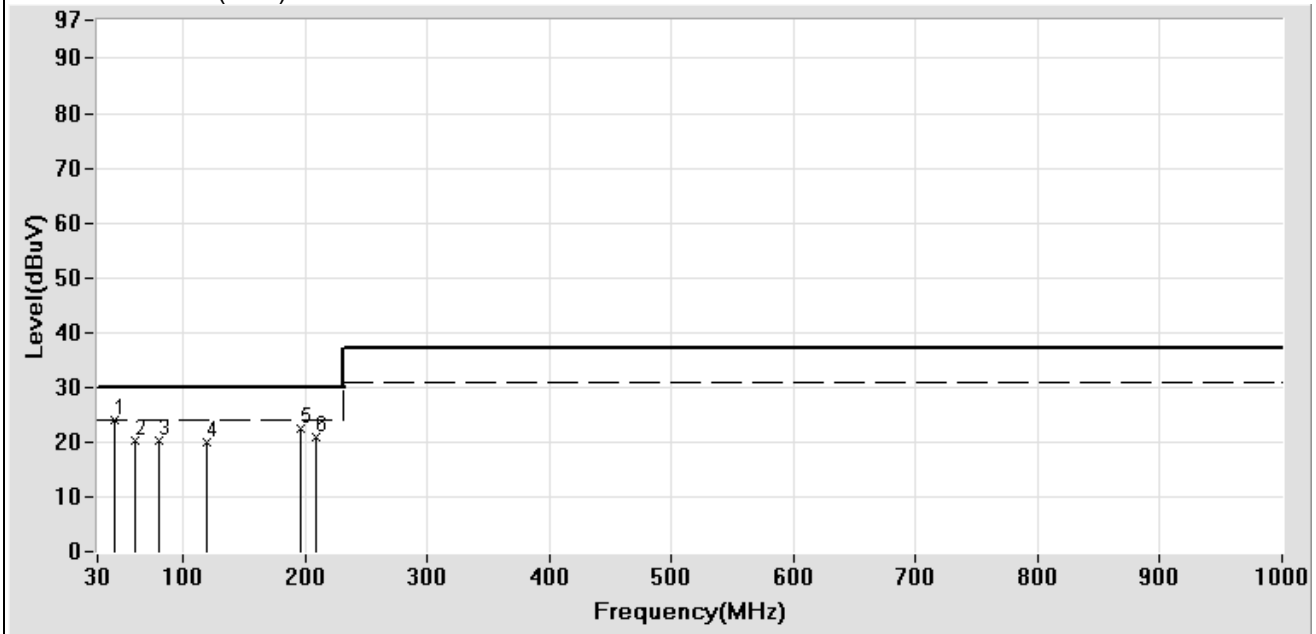

Test Mode: Mode 30: HALF LOAD (NSD10-48S12)

### Radiated Emission Measurement Data

EUT: Switching Power Supply CLIENT: MEAN WELL MODEL: NSD10-48S15 RATING: DC 48V Temperature: 16.0 °C Humidity: 56 %	POLARITY: Horizontal DISTANCE: 10 m Serial No.: FILE/DATA#: MEAN WELL.emi/40 OPERATOR: Nigel TEST SITE: OATS1
--	--

Frequency	Factor	Meter Reading	Emission Level	Limits	Margin
(MHz)	(dB)	(dBμV)	(dBμV/m)	(dBμV/m)	(dB)
60.521 **	-21.36	38.99	17.63	30.00	-12.37
71.593 **	-23.21	41.58	18.37	30.00	-11.63
83.590 **	-21.44	38.89	17.45	30.00	-12.55
115.587 **	-17.12	35.69	18.57	30.00	-11.43
120.158 **	-16.77	35.47	18.70	30.00	-11.30
206.578 **	-12.40	30.56	18.16	30.00	-11.84

**Remark:**

1. “\*” Mark means readings are Peak Values.
2. “\*\*” Mark means readings are Quasi-Peak values.
3. Factor = Antenna Factor + Cable Loss – Pre-amplifier.

LIMIT: CISPR22B(10M).LMT

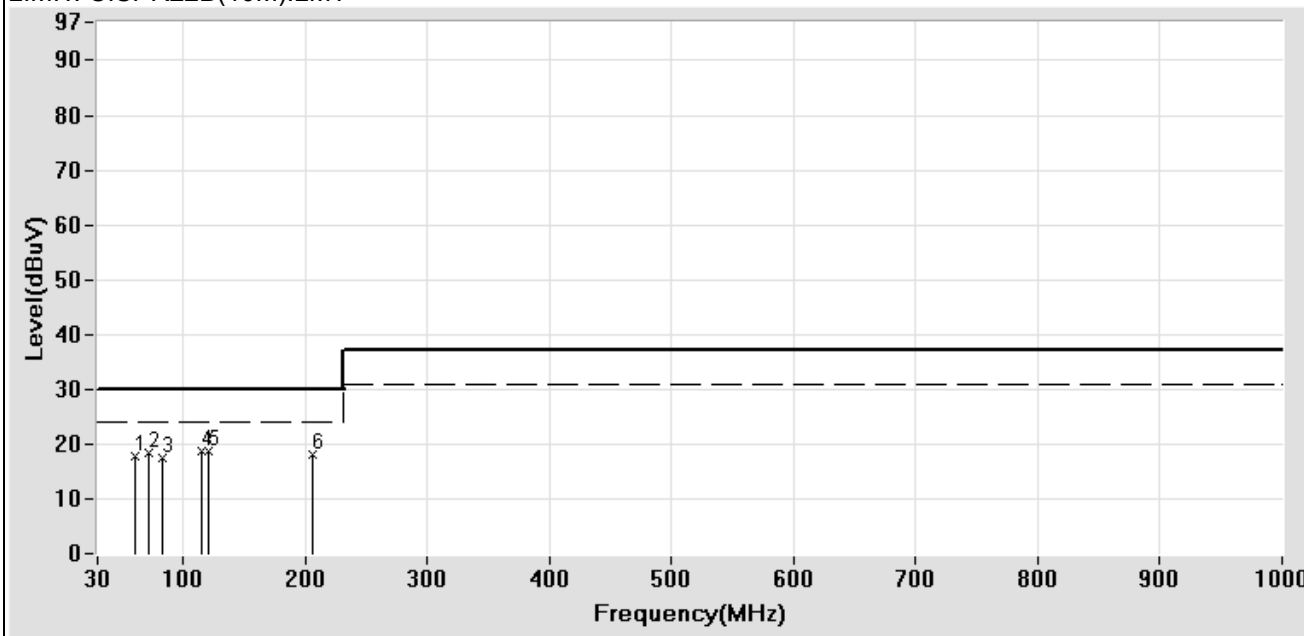

Test Mode: Mode 31: FULL LOAD (NSD10-48S15)

### Radiated Emission Measurement Data

EUT: Switching Power Supply CLIENT: MEAN WELL MODEL: NSD10-48S15 RATING: DC 48V Temperature: 16.0 °C Humidity: 56 %	POLARITY: Vertical DISTANCE: 10 m Serial No.: FILE/DATA#: MEAN WELL.emi/41 OPERATOR: Nigel TEST SITE: OATS1
--	--

Frequency	Factor	Meter Reading	Emission Level	Limits	Margin
(MHz)	(dB)	(dBμV)	(dBμV/m)	(dBμV/m)	(dB)
46.125 **	-17.25	37.85	20.60	30.00	-9.40
56.292 **	-20.09	42.56	22.47	30.00	-7.53
85.560 **	-21.24	41.87	20.63	30.00	-9.37
115.147 **	-17.15	36.89	19.74	30.00	-10.26
176.258 **	-12.90	31.57	18.67	30.00	-11.33
206.571 **	-12.40	31.24	18.84	30.00	-11.16

**Remark:**

1. “\*” Mark means readings are Peak Values.
2. “\*\*” Mark means readings are Quasi-Peak values.
3. Factor = Antenna Factor + Cable Loss – Pre-amplifier.

LIMIT: CISPR22B(10M).LMT

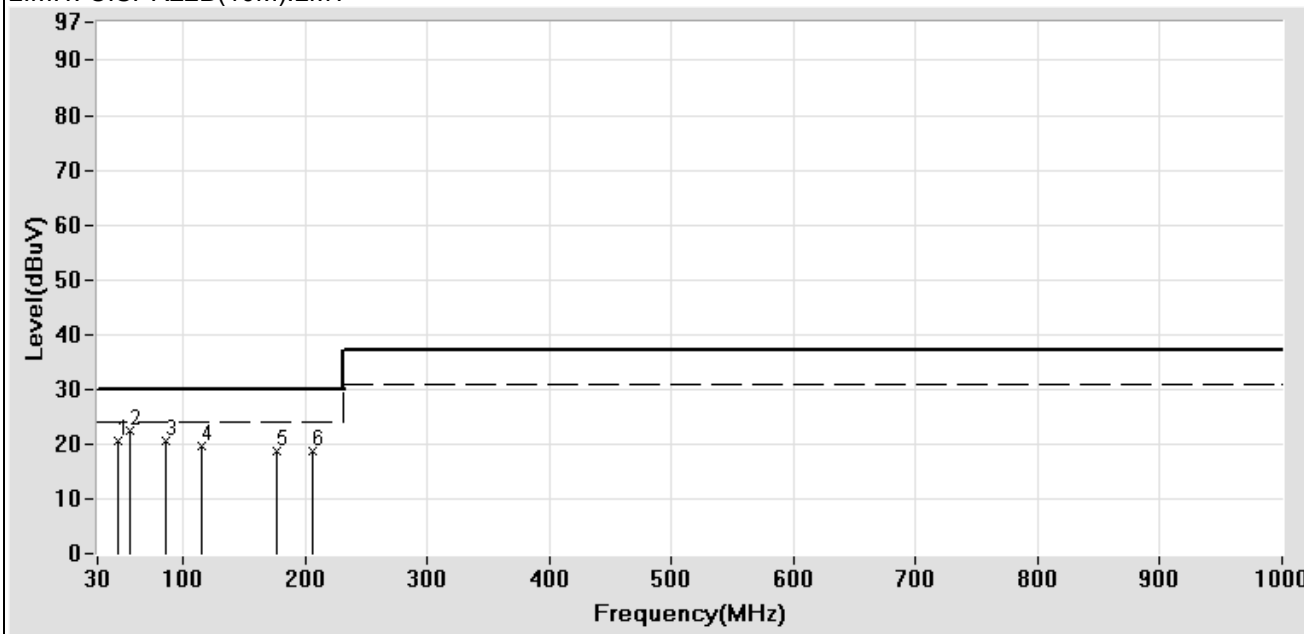

Test Mode: Mode 31: FULL LOAD (NSD10-48S15)

## Radiated Emission Measurement Data

EUT: Switching Power Supply CLIENT: MEAN WELL MODEL: NSD10-48S15 RATING: DC 48V Temperature: 18.0 °C Humidity: 79 %	POLARITY: Horizontal DISTANCE: 10 m Serial No.: FILE/DATA#: MEAN WELL.emi/263 OPERATOR: Nigel TEST SITE: OATS1
--	---

Frequency	Factor	Meter Reading	Emission Level	Limits	Margin
(MHz)	(dB)	(dBμV)	(dBμV/m)	(dBμV/m)	(dB)
56.615 **	-19.10	37.54	18.44	30.00	-11.56
67.010 **	-21.89	39.56	17.67	30.00	-12.33
84.258 **	-20.02	36.58	16.56	30.00	-13.44
119.927 **	-15.35	34.20	18.85	30.00	-11.15
164.561 **	-11.95	31.33	19.38	30.00	-10.62
208.424 **	-10.80	30.10	19.30	30.00	-10.70

**Remark:**

1. “\*” Mark means readings are Peak Values.
2. “\*\*” Mark means readings are Quasi-Peak values.
3. Factor = Antenna Factor + Cable Loss – Pre-amplifier.

LIMIT: CISPR22B(10M).LMT

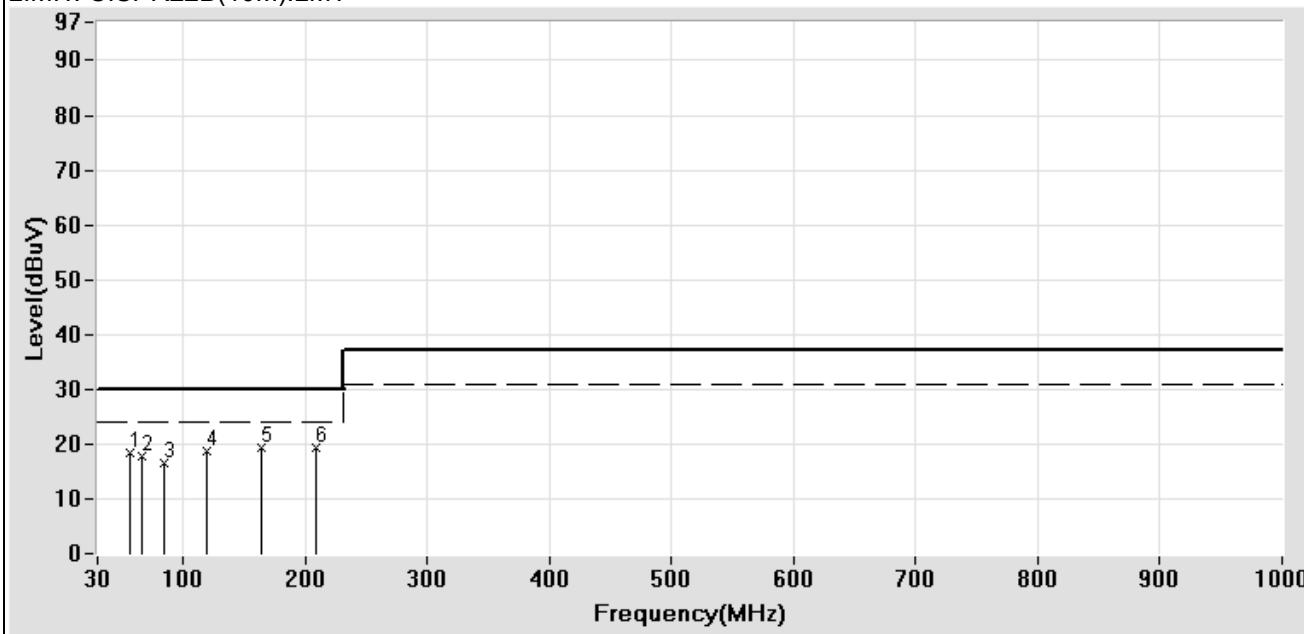

Test Mode: Mode 32: HALF LOAD (NSD10-48S15)

### Radiated Emission Measurement Data

EUT: Switching Power Supply CLIENT: MEAN WELL MODEL: NSD10-48S15 RATING: DC 48V Temperature: 18.0 °C Humidity: 79 %	POLARITY: Vertical DISTANCE: 10 m Serial No.: FILE/DATA#: MEAN WELL.emi/262 OPERATOR: Nigel TEST SITE: OATS1
--	---

Frequency	Factor	Meter Reading	Emission Level	Limits	Margin
(MHz)	(dB)	(dBμV)	(dBμV/m)	(dBμV/m)	(dB)
43.593 **	-15.42	38.56	23.14	30.00	-6.86
63.354 **	-21.13	40.68	19.55	30.00	-10.45
84.372 **	-20.01	38.12	18.11	30.00	-11.89
116.849 **	-15.60	34.19	18.59	30.00	-11.41
189.186 **	-11.02	32.45	21.43	30.00	-8.57
207.655 **	-10.81	31.71	20.90	30.00	-9.10

**Remark:**

1. “ \* ” Mark means readings are Peak Values.
2. “ \*\* ” Mark means readings are Quasi-Peak values.
3. Factor = Antenna Factor + Cable Loss – Pre-amplifier.

LIMIT: CISPR22B(10M).LMT

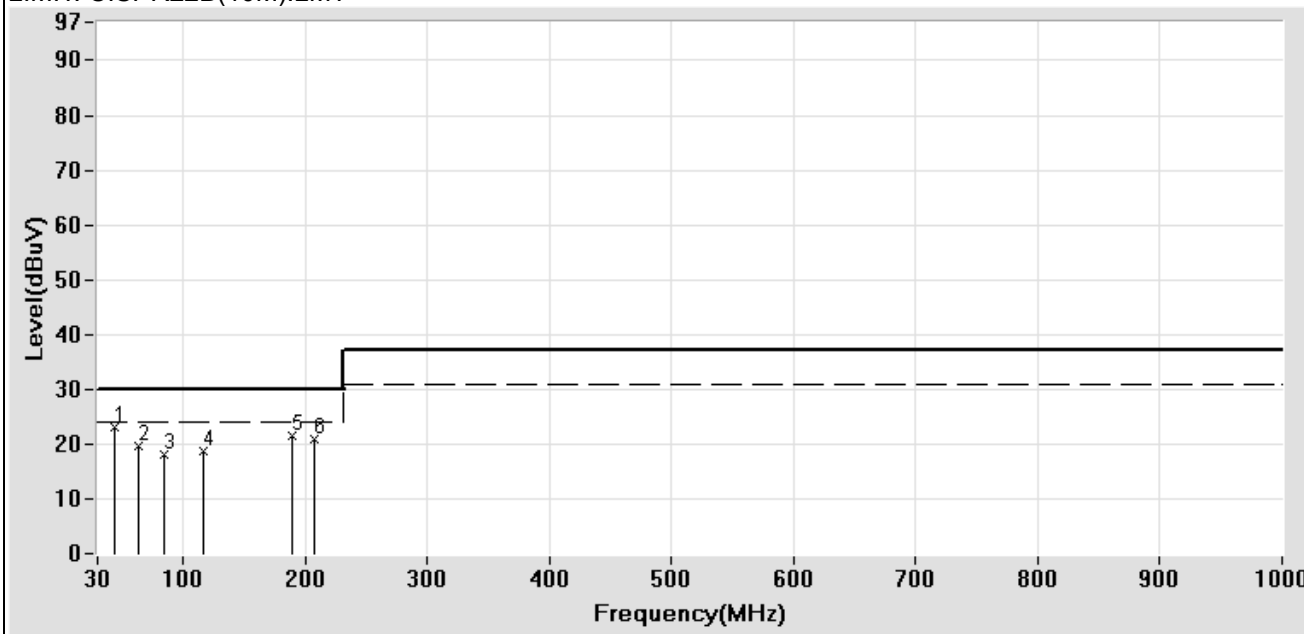

Test Mode: Mode 32: HALF LOAD (NSD10-48S15)

#### **4 Harmonic Current Emission Measurement (EN 61000-3-2)**

This EUT is powered by DC to DC type, therefore it is not specified in this section.

## **5 Voltage Fluctuations and Flicker Measurement (EN 61000-3-3)**

This EUT is powered by DC to DC type, therefore it is not specified in this section.



## 6 Electrostatic Discharge Immunity Test (IEC 61000-4-2)

### 6.1 Instrument

Instrument	Manufacturer	Model	Serial No.	Last Calibration
ESD Simulator	EMC PARTNER	ESD3000	241	2006/10/09

Note: All instrument upon which need to be calibrated are within calibration period of 1 year.

### 6.2 Block Diagram of Test Configuration

Configuration of Instrument Setup.

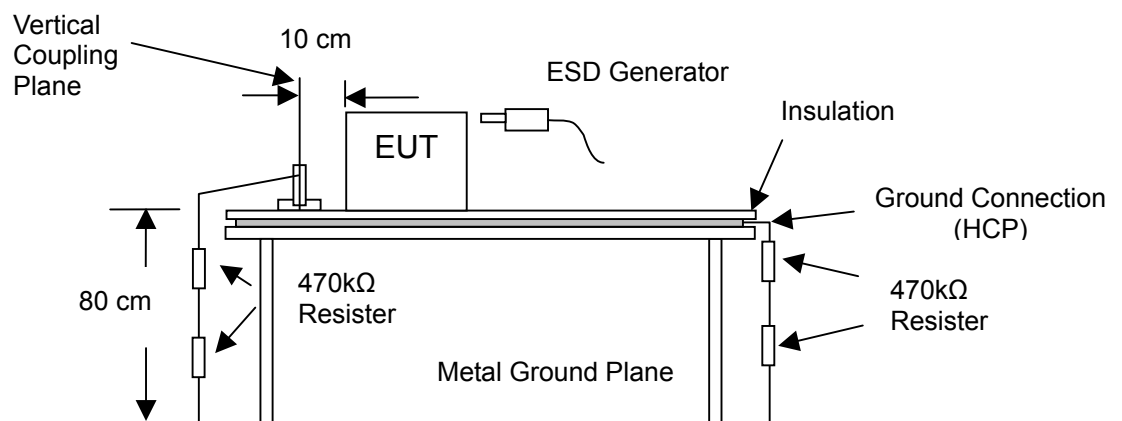

### 6.3 Test Levels & Performance Criterion

#### 6.3.1 Test Levels

Level	Contact discharge (kV)	Air discharge (kV)
1	2	2
2	4	4
3	6	8
4	8	15
X	Specials	Special

#### 6.3.2 Performance Criterion

EN 55024 / EN 61204-3 / EN 61000-6-1

Criterion	Description
A	The equipment shall continue to operate as intended without operator intervention, degradation of performance or loss of function is allowed below a performance level specified by the manufacturer when the equipment is used as intended.
B	After the test, the equipment shall continue to operate as intended without operator intervention, degradation of performance or loss of function is allowed.
C	Loss of function is allowed, provided the function is self-recoverable, or can be restored by the operation of controls by the user in accordance with the manufacturer's instructions.

## 6.4 Test Requirement

- 6.4.1 IEC 61000-4-2 (EN 55024) require:  
Air discharge:  $\pm 8$  KV  
Contact discharge:  $\pm 4$  kV  
Indirect discharge:  $\pm 4$  kV  
Performance criterion: B
- 6.4.2 IEC 61000-4-2 (EN 61000-6-1) require:  
Air discharge:  $\pm 8$  KV  
Contact discharge:  $\pm 4$  kV  
Indirect discharge:  $\pm 4$  kV  
Performance criterion: B
- 6.4.3 IEC 61000-4-2 (EN 61204-3) require:  
Air discharge:  $\pm 8$  KV  
Contact discharge:  $\pm 4$  kV  
Indirect discharge:  $\pm 4$  kV  
Performance criterion: B

## 6.5 Configuration of Measurement

- 6.5.1 Static electricity discharges shall be applied only to those points and surfaces of the EUT which are expected to be touched during usual operation, including user access, as specified in the user manual, for example for ribbon and paper roll changes.
- 6.5.2 The discharges shall be applied in two ways:
- a) Contact discharges to the conductive surfaces and to coupling planes:  
The EUT shall be exposed to at least 200 discharges, 100 each at negative and positive polarity, at a minimum of four test points (a minimum of 50 discharges at each point). One of the test points shall be subjected to at least 50 indirect discharges (contact) to the center of the front edge of the horizontal coupling plane, The remaining three test points shall each receive at least 50 direct contact discharges. If no direct contact test points are available, then at least 200 indirect discharges shall be applied in the indirect mode (see IEC 61000-4-2 for use of the Vertical Conducting Plane (VCP)). Tests shall be performed at a maximum repetition rate of one discharge per second.
  - b) Air discharge at slots and apertures, and insulating surfaces:  
On those parts of the EUT where it is not possible to perform contact discharge testing, the equipment should be investigated to identify user accessible points where breakdown may occur; examples are openings at edges of keys, or in the covers of keyboards and telephone handsets. Such points are tested using the air discharge method. See also IEC 61000-4-2 regarding painted surfaces. This investigation should be restricted to those areas normally handled by the user. A minimum of 10 single air discharges shall be applied to the selected test point for each such area.
- 6.5.3 The selected points, performed with electrostatic discharge were marked with red arrow (for Contact discharge), and green arrow (for Air discharge) on the EUT. The ESD generator (gun) was held perpendicular to the surface to which the discharge was applied. The application of electrostatic discharges to the contacts of open connectors is not required.

## 6.6 Test Result

6.6.1 The performance criterion after tested IEC 61000-4-2 (EN 55024):

Air discharge:  A  B  C

Contact discharge:  A  B  C

Indirect discharge:  A  B  C

**Note: There is no Air discharge point and Contact discharge point.**

6.6.2 The performance criterion after tested IEC 61000-4-2 (EN 61000-6-1):

Air discharge:  A  B  C

Contact discharge:  A  B  C

Indirect discharge:  A  B  C

**Note: There is no Air discharge point and Contact discharge point.**

6.6.3 The performance criterion after tested IEC 61000-4-2 (EN 61204-3):

Air discharge:  A  B  C

Contact discharge:  A  B  C

Indirect discharge:  A  B  C

**Note: There is no Air discharge point and Contact discharge point.**

## 7 Radio-Frequency, Electromagnetic Field Immunity Test (IEC 61000-4-3)

### 7.1 Instrument

Instrument	Manufacturer	Model	Serial No.	Last Calibration
Signal Generator	R&S	SMY02	829846/013	2006/07/20
Power Amplifier	KALMUS	7100LC	8948-1	2006/06/19
Field Probe	HOLADAY INDUSTRIES	HI-4422	101635	2006/04/19
Coupler	WERLATONE	C2630	8067	N. C. R.
Bilog Antenna	SCHWARZBECK	VULB9161	4023	2006/09/13
Power Meter	Agilent	E4419B	GB40201802	2006/06/19

Note: All instrument upon which need to be calibrated are within calibration period of 1 year.

### 7.2 Block Diagram of Test Configuration

Configuration of Instrument Setup.

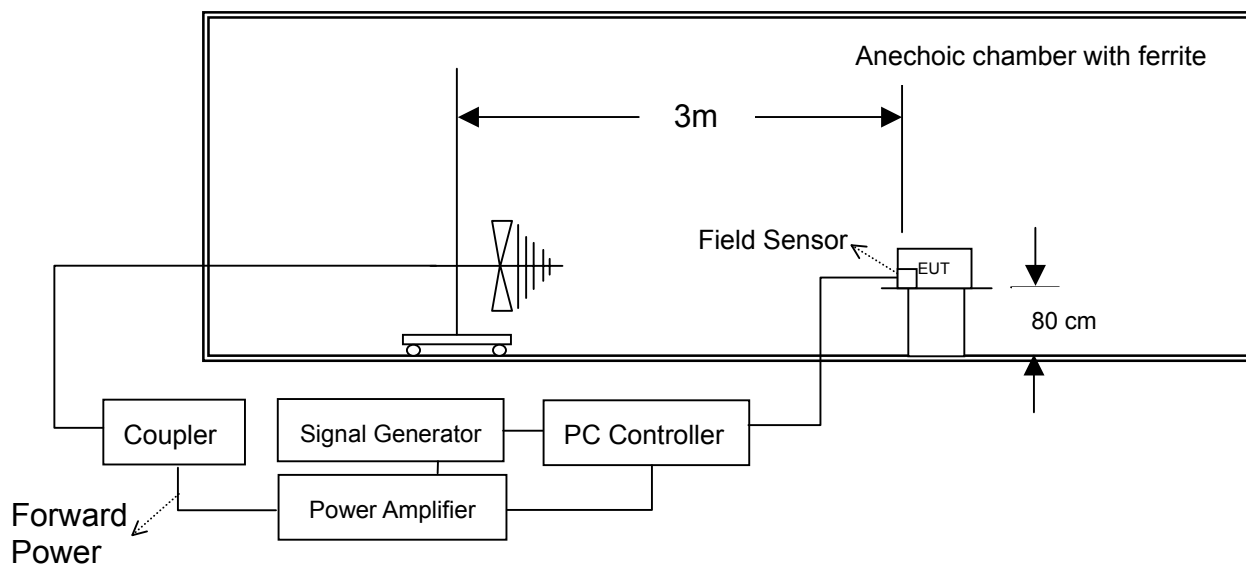

### 7.3 Test Levels & Performance Criterion

#### 7.3.1 Test Levels

Level	Test field strength (V/m)
1	1
2	3
3	10
X	Special

#### 7.3.2 Performance Criterion

EN 55024 / EN 61204-3 / EN 61000-6-1 / ENV 50204

Criterion	Description
A	The equipment shall continue to operate as intended without operator intervention, degradation of performance or loss of function is allowed below a performance level specified by the manufacturer when the equipment is used as intended.
B	After the test, the equipment shall continue to operate as intended without operator intervention, degradation of performance or loss of function is allowed.
C	Loss of function is allowed, provided the function is self-recoverable, or can be restored by the operation of controls by the user in accordance with the manufacturer's instructions.

### 7.4 Test Requirement

#### 7.4.1 IEC 61000-4-3 (EN 55024) require:

Frequency range: 80 to 1000 MHz, Field strength: 3 V/m, 80% AM (1kHz),  
Performance criterion: A

#### 7.4.2 IEC 61000-4-3 (EN 61204-3) require:

Frequency range: 80 to 1000 MHz, Field strength: 3 V/m, 80% AM (1kHz),  
Performance criterion: B

Frequency range: 900 +/- 5 MHz, Field strength: 3 V/m, 50% duty cycle, rep. Frequency  
200Hz, Performance criterion: B

#### 7.4.3 ENV 50204 require:

Frequency range: 900 +/- 5 MHz, Field strength: 3 V/m, 50% duty cycle, rep. Frequency  
200Hz, Performance criterion: A

#### 7.4.4 IEC 61000-4-3 (EN 61000-6-1) require:

Frequency range: 80 to 1000 MHz, Field strength: 3 V/m, 80% AM (1kHz),  
Performance criterion: A

## 7.5 Configuration of Measurement

- 7.5.1 Before testing, the intensity of the established field strength was checked by placing the field sensor at a calibration grid point, and with the field generating antenna and cables in the same positions as used for the calibration, the forward and reverse power were measured. The forward power needed to give the calibrated field was evaluated.
- 7.5.2 After the calibration had been verified, the test field was then generated using the values obtained from the calibration. The EUT and the auxiliary equipment were placed on a table with 0.8 meters height. The EUT was initially placed with one face coincidence with the calibration plane at a distance of 3 meters away from the illuminating antenna (the same as used for the field calibration). Both horizontal and vertical polarizations of the antenna and four sides of the EUT were set for the radiated field immunity test.
- 7.5.3 In order to survey the performance of the EUT, a CCD camera was used to monitor the EUT performance.

## 7.6 Test Result

- 7.6.1 The performance criterion after tested IEC 61000-4-3 (EN 55024)  
 Frequency range: **80 to 1000** MHz, Field strength: **3** V/m, 80% AM (1kHz),  
Performance criterion:  **A**  **B**  **C**
- 7.6.2 The performance criterion after tested IEC 61000-4-3 (EN 61204-3):  
 Frequency range: **80 to 1000** MHz, Field strength: **3** V/m, 80% AM (1kHz),  
Performance criterion:  **A**  **B**  **C**
- Frequency range: **900 +/- 5** MHz, Field strength: **3** V/m, 50% duty cycle, rep.  
Frequency **200**Hz  
Performance criterion:  **A**  **B**  **C**
- 7.6.3 The performance criterion after tested ENV 50204:  
 Frequency range: **900 +/- 5** MHz, Field strength: **3** V/m, 50% duty cycle, rep.  
Frequency **200**Hz  
Performance criterion:  **A**  **B**  **C**
- 7.6.4 The performance criterion after tested IEC 61000-4-3 (EN 61000-6-1):  
 Frequency range: **80 to 1000** MHz, Field strength: **3** V/m, 80% AM (1kHz),  
Performance criterion:  **A**  **B**  **C**



## 8 Electrical Fast Transient/Burst Immunity Test (IEC 61000-4-4)

### 8.1 Instrument

Instrument	Manufacturer	Model	Serial No.	Last Calibration
EMC Pro System	KeyTek	EMC Pro	0003231	2006/03/20
EFT Clamp	KeyTek	PRO-CCL-C	0003198	N. C. R.

Note: All instrument upon which need to be calibrated are within calibration period of 1 year.

### 8.2 Block Diagram of Test Configuration

Configuration of Instrument Setup.

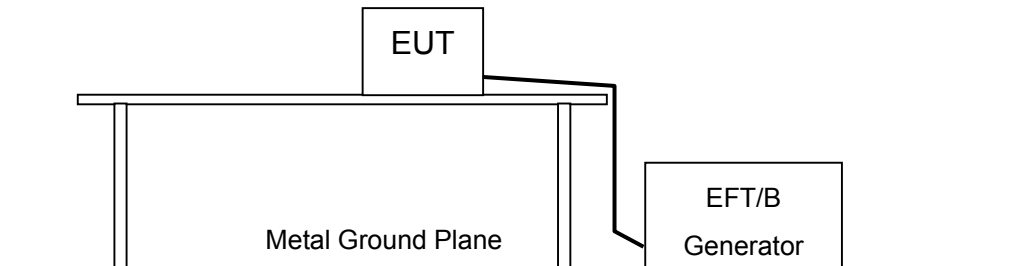

### 8.3 Test Levels & Performance Criterion

#### 8.3.1 Test Levels

Level	On power supply port, PE		On I/O signal, data and control ports	
	Voltage Peak (kV)	Repetition rate (kHz)	Voltage Peak (kV)	Repetition rate (kHz)
1	0.5	5	0.25	5
2	1	5	0.5	5
3	2	5	1	5
4	4	2.5	2	5
X	Special	Special	Special	Special

#### 8.3.2 Performance Criterion

EN 55024 / EN 61204-3 / EN 61000-6-1

Criterion	Description
A	The equipment shall continue to operate as intended without operator intervention, degradation of performance or loss of function is allowed below a performance level specified by the manufacturer when the equipment is used as intended.
B	After the test, the equipment shall continue to operate as intended without operator intervention, degradation of performance or loss of function is allowed.
C	Loss of function is allowed, provided the function is self-recoverable, or can be restored by the operation of controls by the user in accordance with the manufacturer's instructions.

## 8.4 Test Requirement

- 8.4.1 5 kHz Repetition frequency
- 8.4.2 IEC 61000-4-4 (EN 55024) require:  
 0.5 kV input d.c power ports.  
Performance criterion: B
- 8.4.3 IEC 61000-4-4 (EN 61204-3) require:  
 0.5 kV input d.c power ports.  
Performance criterion: B
- 8.4.4 IEC 61000-4-4 (EN 61000-6-1) require:  
 0.5 kV input d.c power ports.  
Performance criterion: B

## 8.5 Configuration of Measurement

- 8.5.1 The EUT and the auxiliary equipment were placed on a wooden table of 0.8 meters height. The size of ground plane is greater than 1m×1m and project beyond the EUT by at least 0.1m on all sides. The ground plane is connected to the protective earth.
- 8.5.2 The EUT was connected to the power mains through a coupling device that directly couples the EFT interference signal. Each of the Line, Neutral and Protective Earth (PE) conductors was impressed with burst noise for 1 minute. Both the voltage polarities were applied for each test level. The length of power cord between the coupling device and the EUT was less than 1 meter.

## 8.6 Test Result

- 8.6.1 The performance criterion after tested IEC 61000-4-4 (EN 55024):  
 5 kHz Repetition frequency; 0.5 kV input dc power ports,  
Performance criterion:  **A**  **B**  **C**
- 8.6.2 The performance criterion after tested IEC 61000-4-4 (EN 61204-3):  
 5 kHz Repetition frequency; 0.5 kV input dc power ports,  
Performance criterion:  **A**  **B**  **C**
- 8.6.3 The performance criterion after tested IEC 61000-4-4 (EN 61000-6-1):  
 5 kHz Repetition frequency; 0.5 kV input dc power ports,  
Performance criterion:  **A**  **B**  **C**

## 9 Surge Immunity Test (IEC 61000-4-5)

### 9.1 Instrument

Instrument	Manufacturer	Model	Serial No.	Last Calibration
EMC Pro Systems	KeyTek	EMC Pro	0003234	2006/03/20
Surge Telecom Box	KeyTek	CM-TELCD	0202316	N. C. R.

Note: All instrument upon which need to be calibrated are within calibration period of 1 year.

### 9.2 Block Diagram of Test Configuration

Configuration of Instrument Setup.

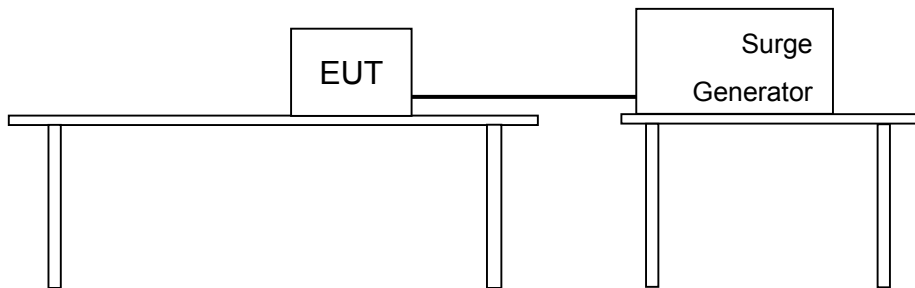

### 9.3 Test Levels & Performance Criterion

#### 9.3.1 Test Levels

Level	Open-circuit test voltage (kV) Line to earth	Open-circuit test voltage (kV) Line to line
1	0.5	--
2	1.0	0.5
3	2.0	1.0
4	4.0	2.0
X	Special	--

NOTE: x is an open class. This level can be specified in the product specification.

#### 9.3.2 Performance Criterion

EN 55024 / EN 61204-3 / EN 61000-6-1

Criterion	Description
A	The equipment shall continue to operate as intended without operator intervention, degradation of performance or loss of function is allowed below a performance level specified by the manufacturer when the equipment is used as intended.
B	After the test, the equipment shall continue to operate as intended without operator intervention, degradation of performance or loss of function is allowed.
C	Loss of function is allowed, provided the function is self-recoverable, or can be restored by the operation of controls by the user in accordance with the manufacturer's instructions.

## 9.4 Test Requirement

9.4.1 IEC 61000-4-5 (EN 55024) require:

Input dc power ports: 0.5kV(peak): line to line, 1.2/50 (8/20) Tr/Th us

Performance criterion: **B**

9.4.2 IEC 61000-4-5 (EN 61204-3) require:

Input dc power ports: 0.5kV(peak): line to line, 1.2/50 (8/20) Tr/Th us

Performance criterion: **B**

9.4.3 IEC 61000-4-5 (EN 61000-6-1) require:

Input dc power ports: 0.5kV(peak): line to line, 1.2/50 (8/20) Tr/Th us

Performance criterion: **B**

## 9.5 Configuration of Measurement

9.5.1 The EUT and the auxiliary equipment were placed on a table of 0.8m heights above a metal ground reference plane. The size of ground plane is greater than 1m×1m and project beyond the EUT by at least 0.1m on all sides. The ground plane is connected to the protective earth. The length of power cord between the coupling device and the EUT was less than 2 meters (provided by the manufacturer).

9.5.2 The EUT was connected to the power mains through a coupling device that directly couples the Surge interference signal. The surge noise was applied synchronized to the voltage phase at the zero crossing and the peak value of the AC voltage wave (positive and negative).

9.5.3 The surges were applied line to line and line(s) to earth. When testing line to earth the test voltage was applied successively between each of the lines and earth. Steps up to the test level specified increased the test voltage. All lower levels including the selected test level were tested. The polarity of each surge level included positive and negative test pulses.

## 9.6 Test Result

9.6.1 The performance criterion after tested IEC 61000-4-5 (EN 55024):

Input dc power ports: 0.5kV(peak) line to line

Performance criterion:  **A**     **B**     **C**

9.6.2 The performance criterion after tested IEC 61000-4-5 (EN 61204-3):

Input dc power ports: 0.5kV(peak) line to line

Performance criterion:  **A**     **B**     **C**

9.6.3 The performance criterion after tested IEC 61000-4-5 (EN 61000-6-1):

Input dc power ports: 0.5kV(peak) line to line

Performance criterion:  **A**     **B**     **C**

## 10 Radio-Frequency, Conducted Disturbances Immunity Test (IEC 61000-4-6)

### 10.1 Instrument

Instrument	Manufacturer	Model	Serial No.	Last Calibration
Signal Generator	R&S	SMY02	829846/013	2006/07/20
Power Amplifier	KALMUS	225LC	8948-1	2006/06/19
Coupler	WERLATONE	C2630	8067	N. C. R.
Attenuator	BIRD Electronic Corp.	25-A-MFN-06	00026	2006/05/19
M3 C.D.N	FCC	FCC-801-M3-25A	2045	2006/05/24
M2 C.D.N	SCHAFFNER	M216	16394	2006/05/24
Power Meter	Agilent	E4479B	GB40201802	2006/06/19

Note: All instrument upon which need to be calibrated are within calibration period of 1 year.

Instrument	Manufacturer	Model	Serial No.	Last Calibration
EM-CLAMP	SCHAFFNER	KEMZ 801	17037	2005/06/14

Note: All instrument upon which need to be calibrated are within calibration period of 2 year

### 10.2 Block Diagram of Test Configuration

Configuration of Instrument Setup.

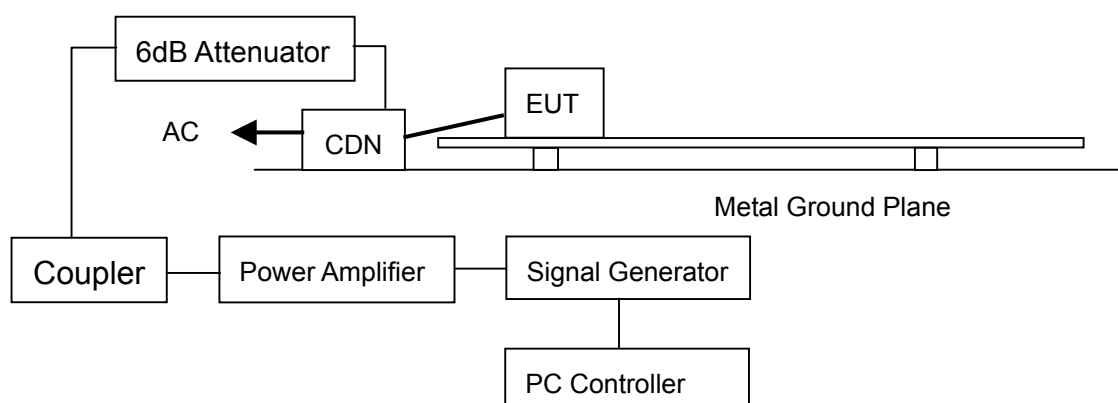

### 10.3 Test Levels & Performance Criterion

#### 10.3.1 Test Levels

Level	Voltage Level (V)
1	1
2	3
3	10
X	Special

#### 10.3.2 Performance Criterion

EN 55024 / EN 61204-3 / EN 61000-6-1

Criterion	Description
A	The equipment shall continue to operate as intended without operator intervention, degradation of performance or loss of function is allowed below a performance level specified by the manufacturer when the equipment is used as intended.
B	After the test, the equipment shall continue to operate as intended without operator intervention, degradation of performance or loss of function is allowed.
C	Loss of function is allowed, provided the function is self-recoverable, or can be restored by the operation of controls by the user in accordance with the manufacturer's instructions.

### 10.4 Test Requirement

10.4.1 Frequency Range is from 0.15 to 80MHz.

10.4.2 IEC 61000-4-6 (EN 55024) require:

Field strength: 3 V, 80% AM (1kHz)

Input DC power port.

Performance criterion: A

10.4.3 IEC 61000-4-6 (EN 61204-3) require:

Field strength: 3 V, 80% AM (1kHz)

Input DC power port.

Performance criterion: B

10.4.4 IEC 61000-4-6 (EN 61000-6-1) require:

Field strength: 3 V, 80% AM (1kHz)

Input DC power port.

Performance criterion: A



## 10.5 Configuration of Measurement

- 10.5.1 The EUT was placed on a table of is 0.1 m height. In Semi-Anechoic chamber A Ground reference plane was placed on the table and a 0.1 meter insulating support was inserted between the EUT and Ground reference plane.
- 10.5.2 The EUT was connected to the power mains through a Coupling and Decoupling Networks (CDN).
- 10.5.3 The test was performed with the test generator connected to each of the coupling and decoupling devices in turn while the other non-excited RF input ports of the coupling devices were terminated by a 50  $\Omega$  terminator.
- 10.5.4 The frequency range was swept from 150kHz to 80MHz.using the signal levels established during the setting process, and without the disturbance signal 80% amplitude modulated with a 1 kHz sine wave, pausing to adjust the RF signal level or to switch coupling devices as necessary. The rate of sweep was less than  $1.5 \times 10^{-3}$  decades/s. And the step size of the frequency sweep was also less than 1% of the start and thereafter 1% of the preceding frequency value. The dwell time at each frequency was more than the time necessary for the EUT to be excited, and able to respond.
- 10.5.5 The EUT was fully excised during the testing and all the selected excise modes were fully interrogated for susceptibility.

## 10.6 Test Result

- 10.6.1 The performance criterion after tested IEC 61000-4-6 (EN 55024):  
Frequency range: **0.15** to **80** MHz, Field strength: **3** V, 80% AM (1kHz),  
 Input DC power port.  
Performance criterion:  **A**    **B**    **C**
- 10.6.2 The performance criterion after tested IEC 61000-4-6 (EN 61204-3):  
Frequency range: **0.15** to **80** MHz, Field strength: **3** V, 80% AM (1kHz),  
 Input DC power port.  
Performance criterion:  **A**    **B**    **C**
- 10.6.3 The performance criterion after tested IEC 61000-4-6 (EN 61000-6-1):  
Frequency range: **0.15** to **80** MHz, Field strength: **3** V, 80% AM (1kHz),  
 Input DC power port.  
Performance criterion:  **A**    **B**    **C**

## 11 Power Frequency Magnetic Field Immunity Test (IEC 61000-4-8)

### 11.1 Instrument

Instrument	Manufacturer	Model	Serial No.	Last Calibration
Magnetic field generator	PMM	PMM1008	0000J00301	2006/09/06

Note: All instrument upon which need to be calibrated are within calibration period of 2 year.

### 11.2 Block Diagram of Test Configuration

Configuration of Testing Setup

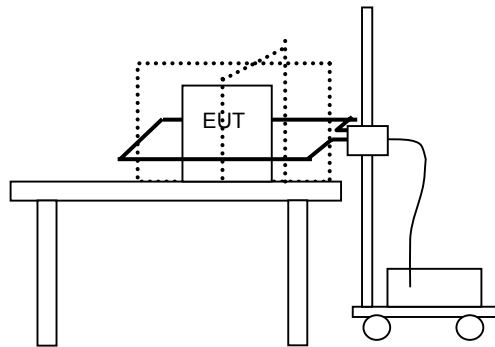

## 11.3 Test Levels & Performance Criterion

### 11.3.1 Test Levels

Level	Magnetic field strength (A/m)
1	1
2	3
3	10
4	30
5	100
X	Special

### 11.3.2 Performance Criterion

EN 55024 / EN 61000-6-1

Criterion	Description
A	The equipment shall continue to operate as intended without operator intervention, degradation of performance or loss of function is allowed below a performance level specified by the manufacturer when the equipment is used as intended.
B	After the test, the equipment shall continue to operate as intended without operator intervention, degradation of performance or loss of function is allowed.
C	Loss of function is allowed, provided the function is self-recoverable, or can be restored by the operation of controls by the user in accordance with the manufacturer's instructions.

## 11.4 Test Requirement

### 11.4.1 IEC 61000-4-8 (EN 55024) require:

Power Frequency is 50Hz.

Magnetic field strength: 1A/m

Performance criterion: **A**

### 11.4.2 IEC 61000-4-8 (EN 61000-6-1) require:

Power Frequency is 50/60Hz.

Magnetic field strength: 3A/m

Performance criterion: **A**

## 11.5 Configuration of Measurement

11.5.1 The equipment is configured and connected to satisfy its functional requirements. It shall be placed on the GRP (1m x 1m) with the interposition of a 0.1m thickness insulating support.

11.5.2 All cables shall be exposed to the magnetic field for 1m of their length.

11.5.3 Different induction coils may be selected for testing in the different orthogonal directions as shown in section 11.2.

11.5.4 Induction coils used in the vertical position (horizontal polarization of the field) can be bonded directly to the ground plane.

## 11.6 Test Result

11.6.1 The performance criterion after tested IEC 61000-4-8 (EN 55024):

Power Frequency is 50Hz, Magnetic field strength: 3A/m

Performance criterion:  **A**  **B**  **C**

11.6.2 The performance criterion after tested IEC 61000-4-8 (EN 61000-6-1):

Power Frequency is 50/60Hz, Magnetic field strength: 3A/m

Performance criterion:  **A**  **B**  **C**

## **12 Voltage Dips, Short Interruptions Immunity Test (IEC 61000-4-11)**

This EUT is powered by DC to DC type, therefore it is not specified in this section.

## 13 Photographs of Test

### 13.1 Radiated Emission Measurement



Front View (Test with 12V)



Rear View (Test with 12V)



Front View (Test with 48V)



Rear View (Test with 48V)



### 13.2 Electrostatic Discharge Immunity Test (IEC 61000-4-2)



### 13.3 Radio-Frequency, Electromagnetic Field Immunity Test (IEC 61000-4-3)

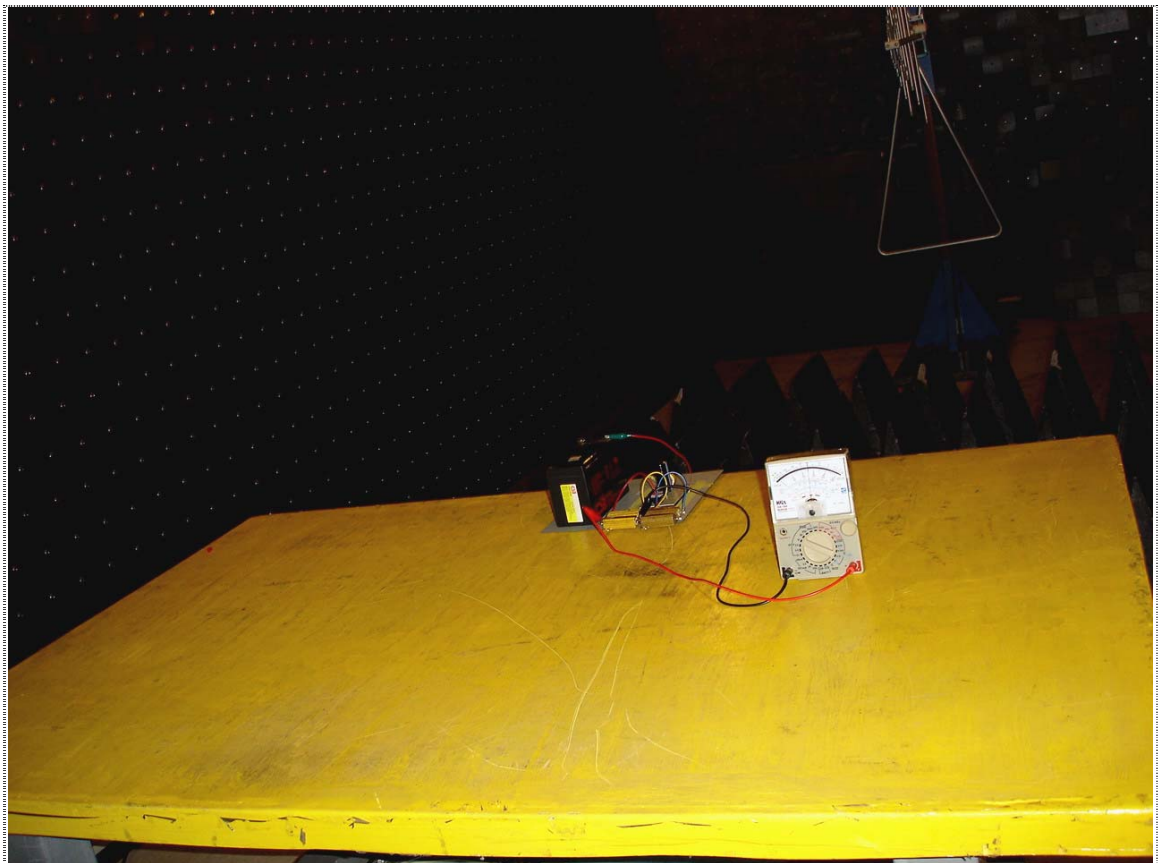

Front View

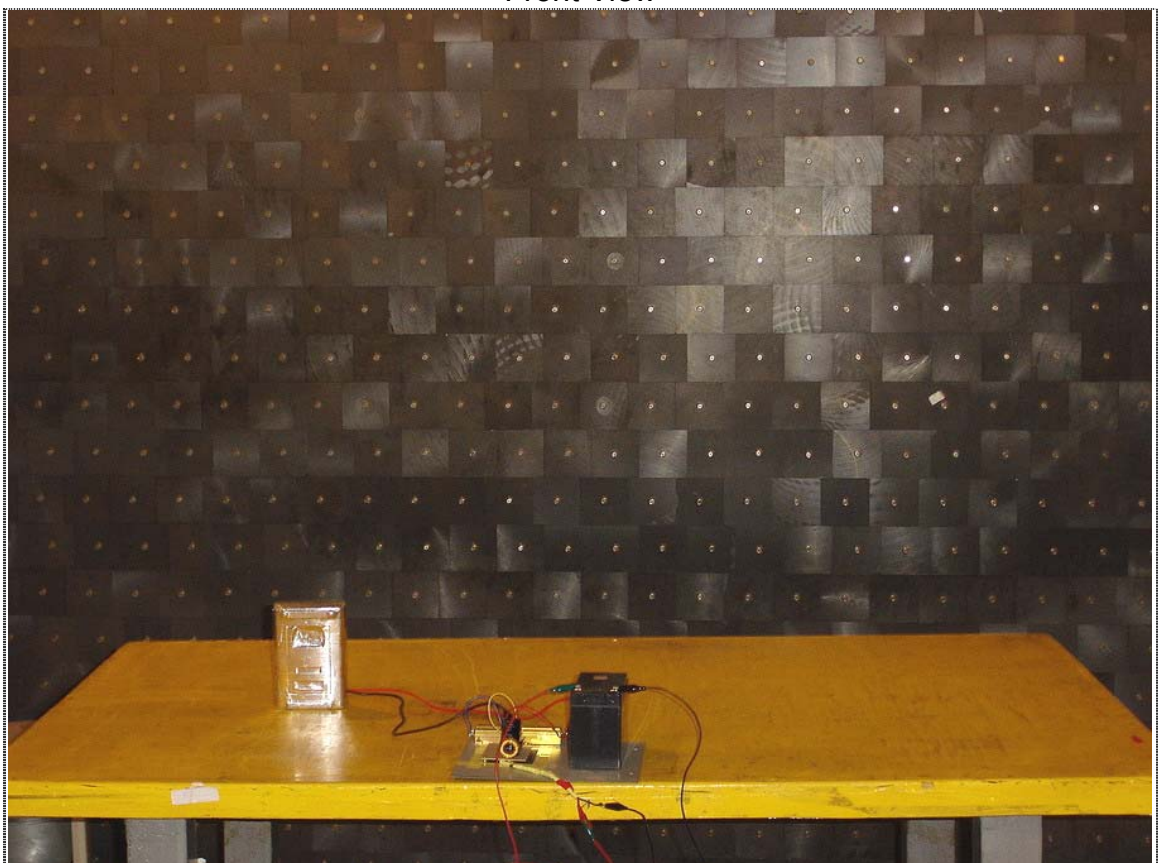

Rear View

### 13.4 Electrical Fast Transient/Burst Immunity Test (IEC 61000-4-4)



### 13.5 Surge Immunity Test (IEC 61000-4-5)



### 13.6 Radio-Frequency, Conducted Disturbances Immunity Test (IEC 61000-4-6)

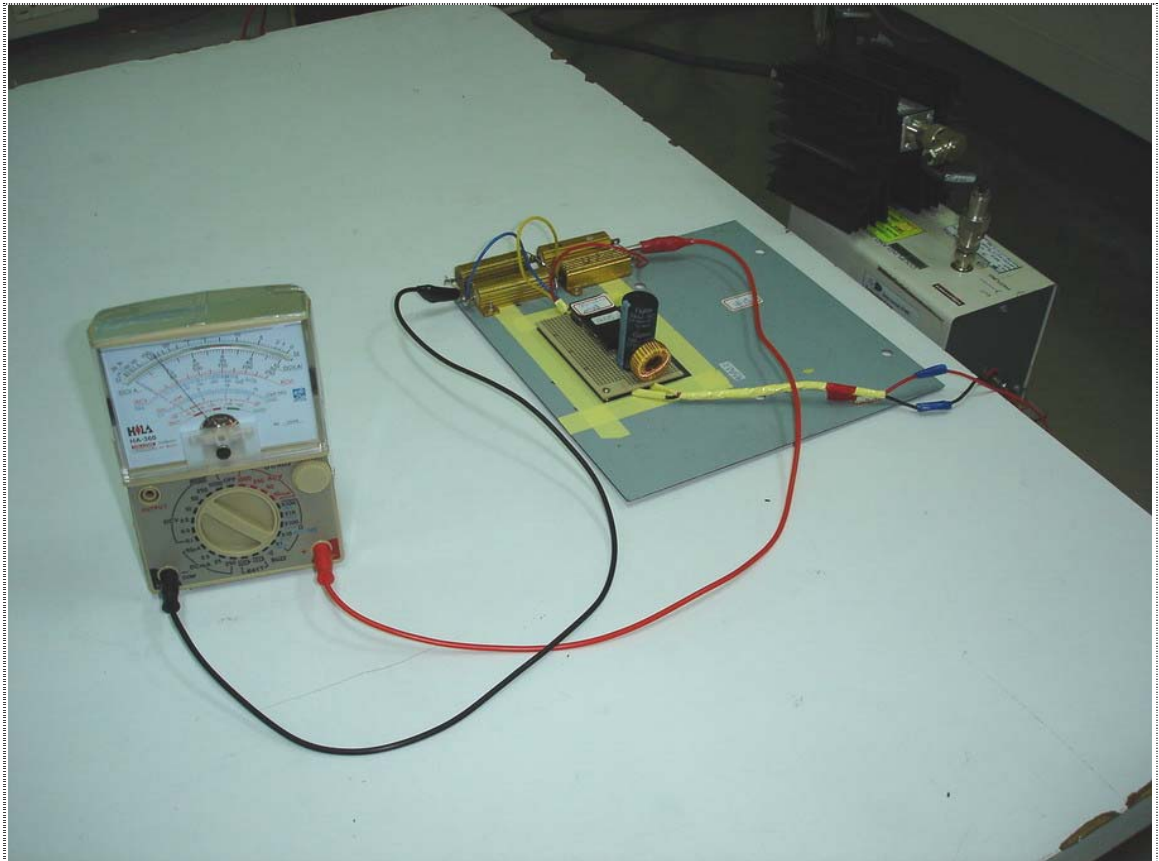

### 13.7 Power Frequency Magnetic Field Immunity Test (IEC 61000-4-8)

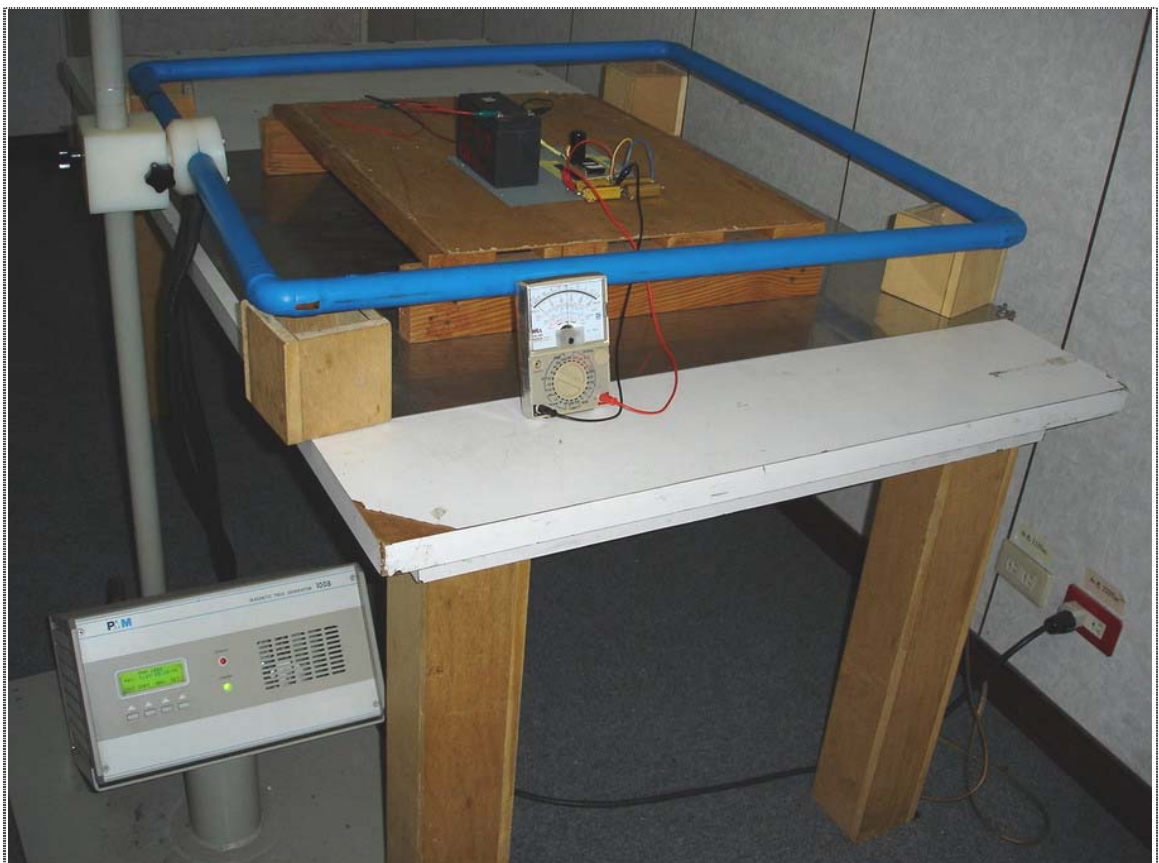

# 14 Photographs of EUT

## 14.1 (Model No.: NSD10-12D5)

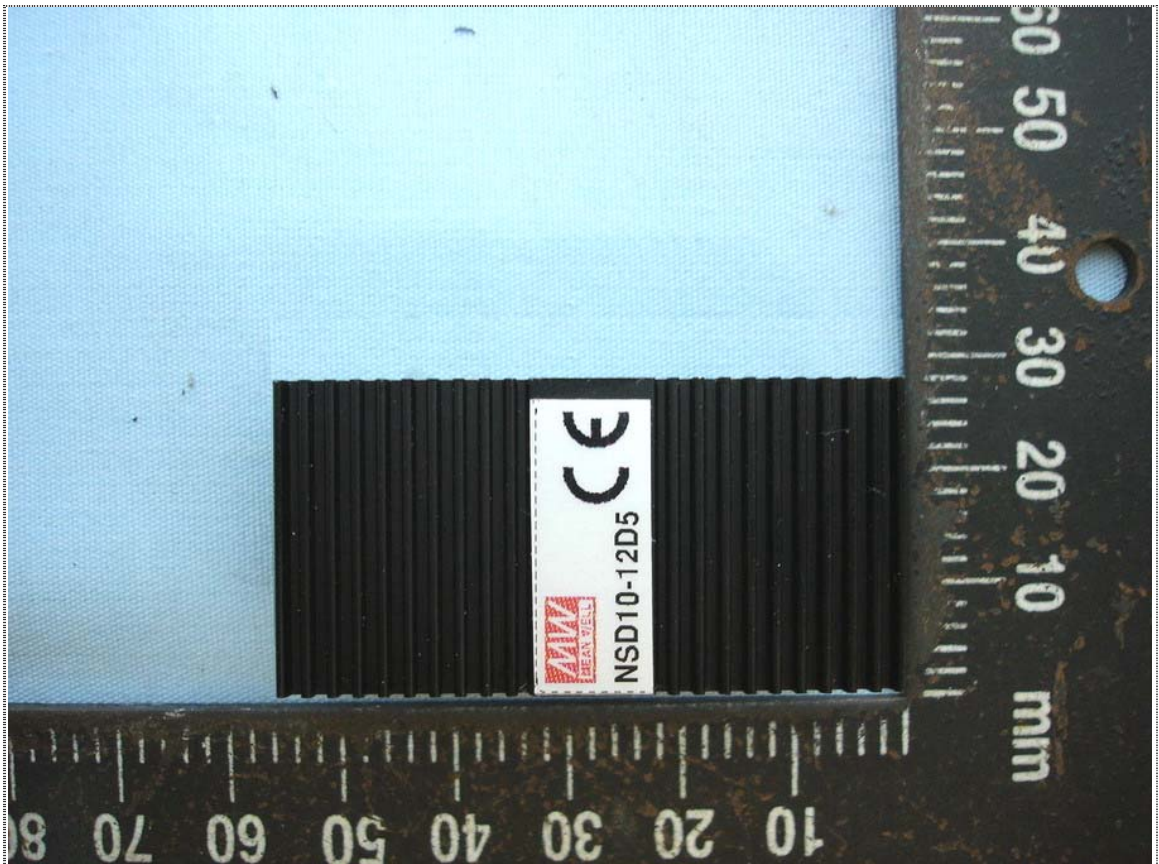

Front View of EUT

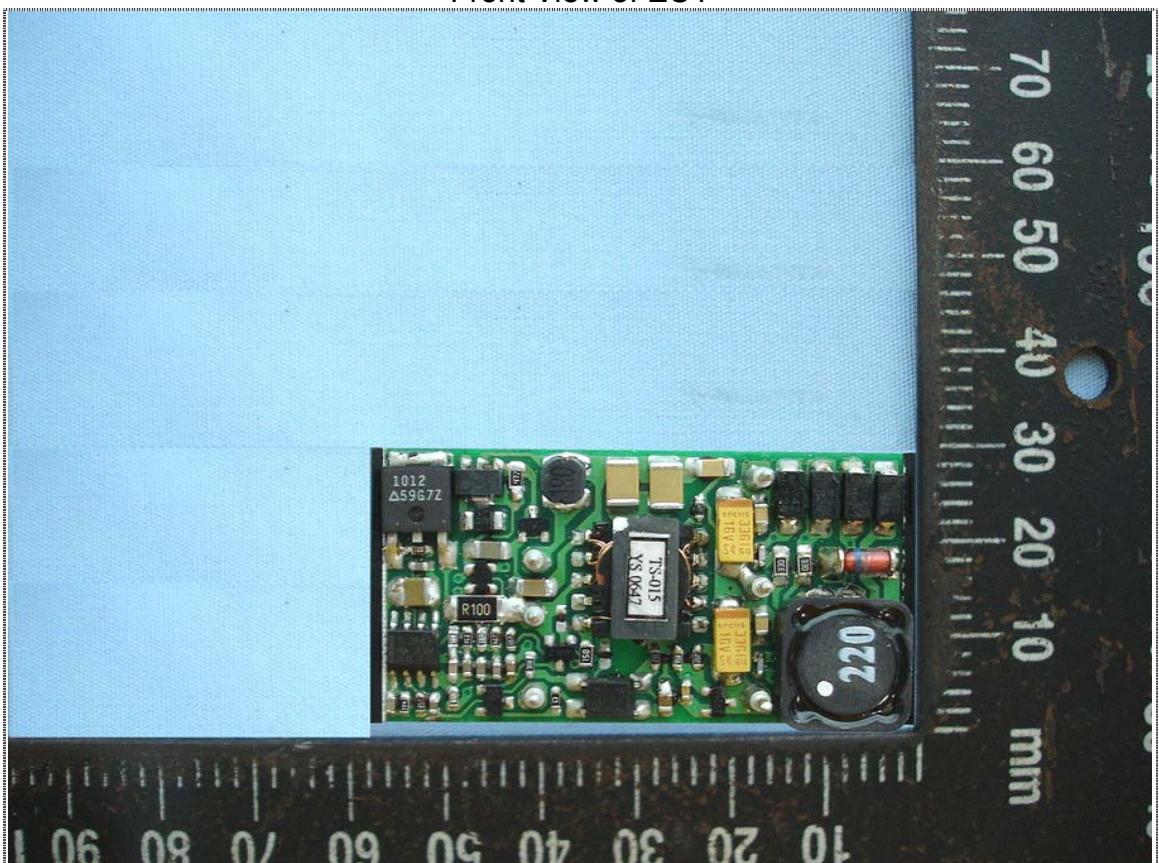

Rear View of EUT

14.2 (Model No.: NSD10-12D12)

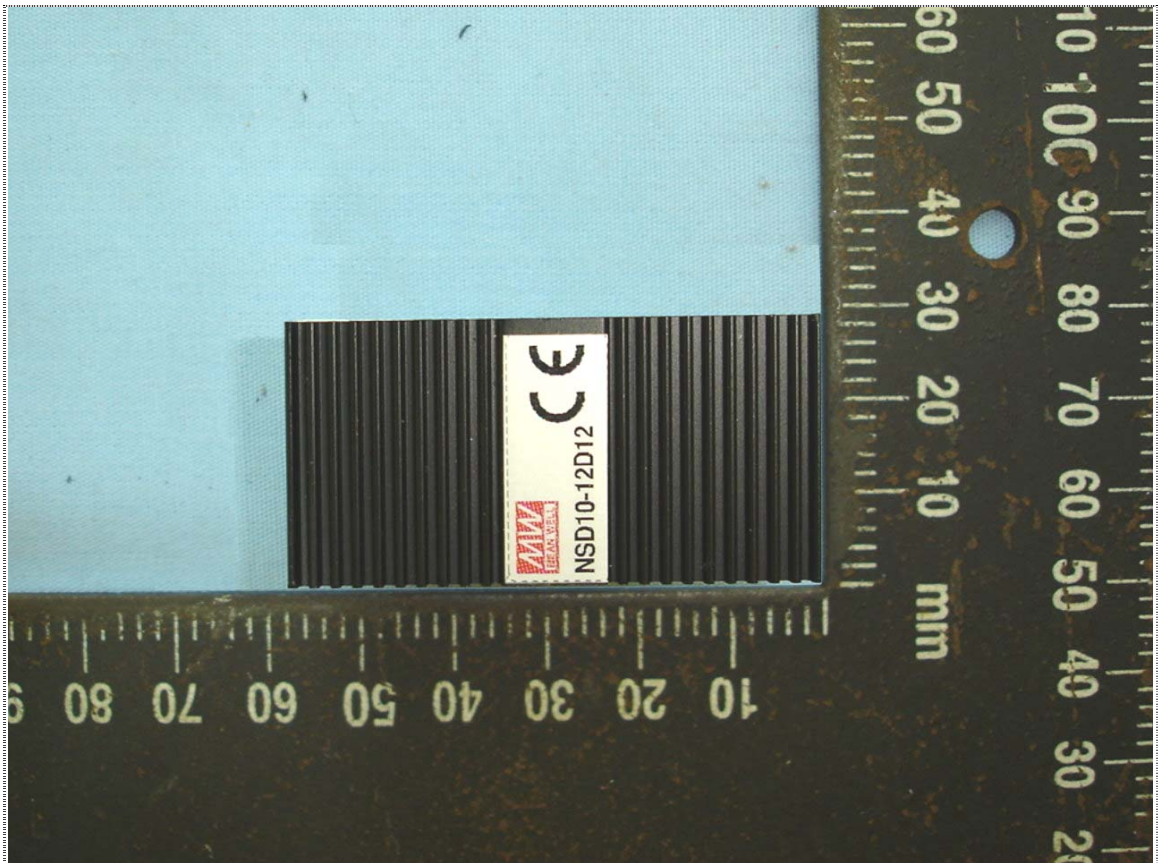

Front View of EUT

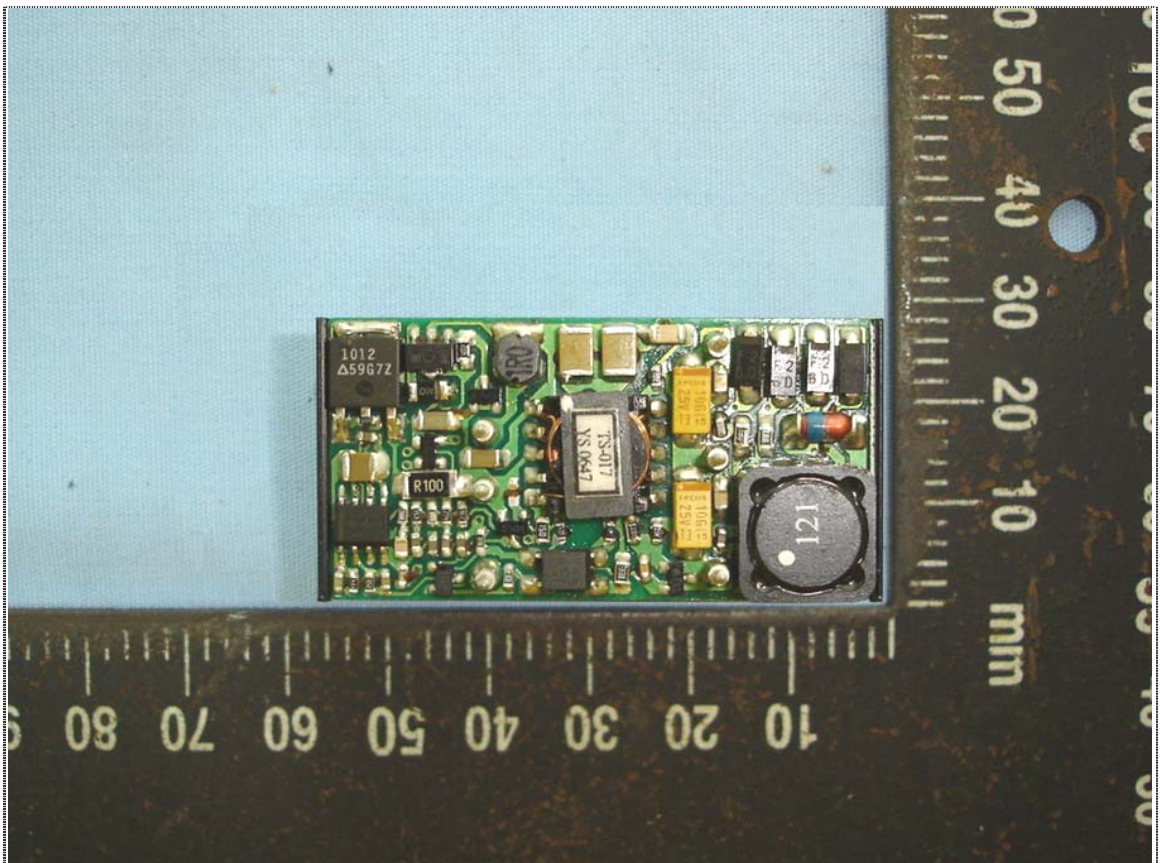

Rear View of EUT

14.3 (Model No.: NSD10-12D15)

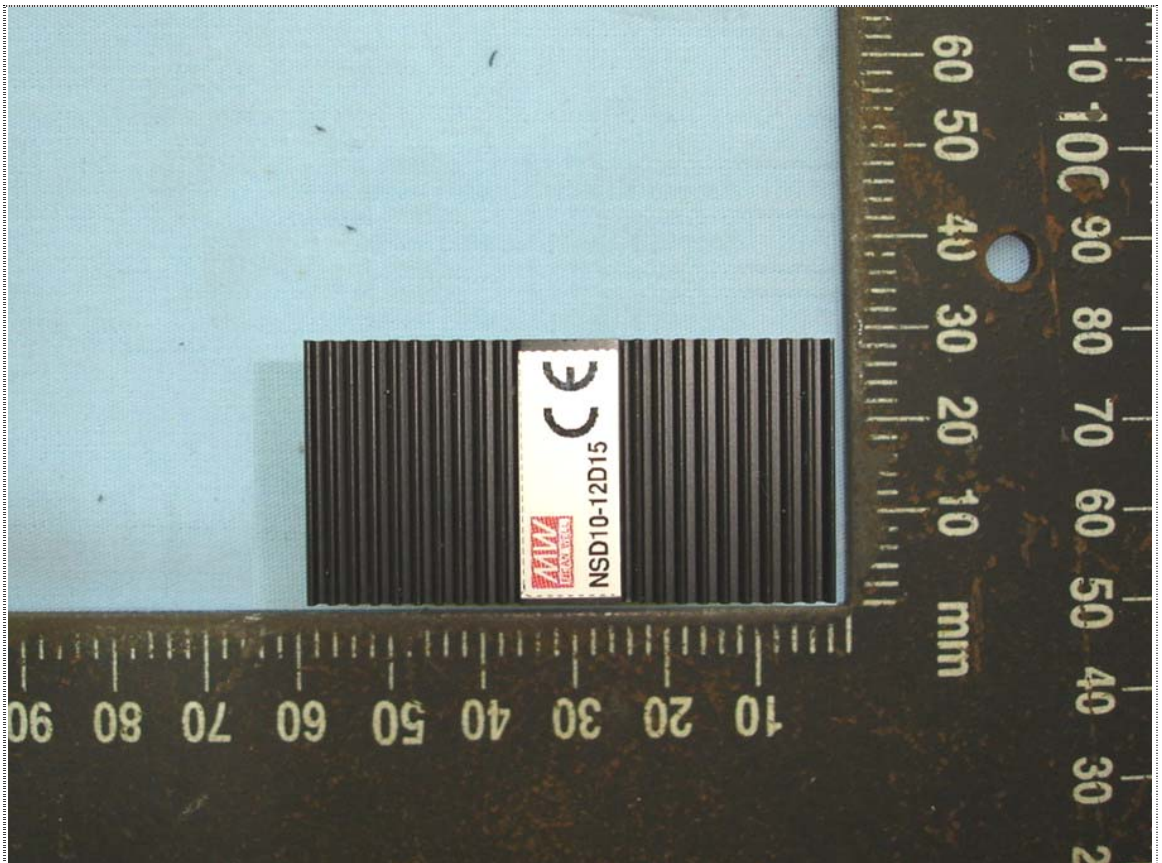

Front View of EUT

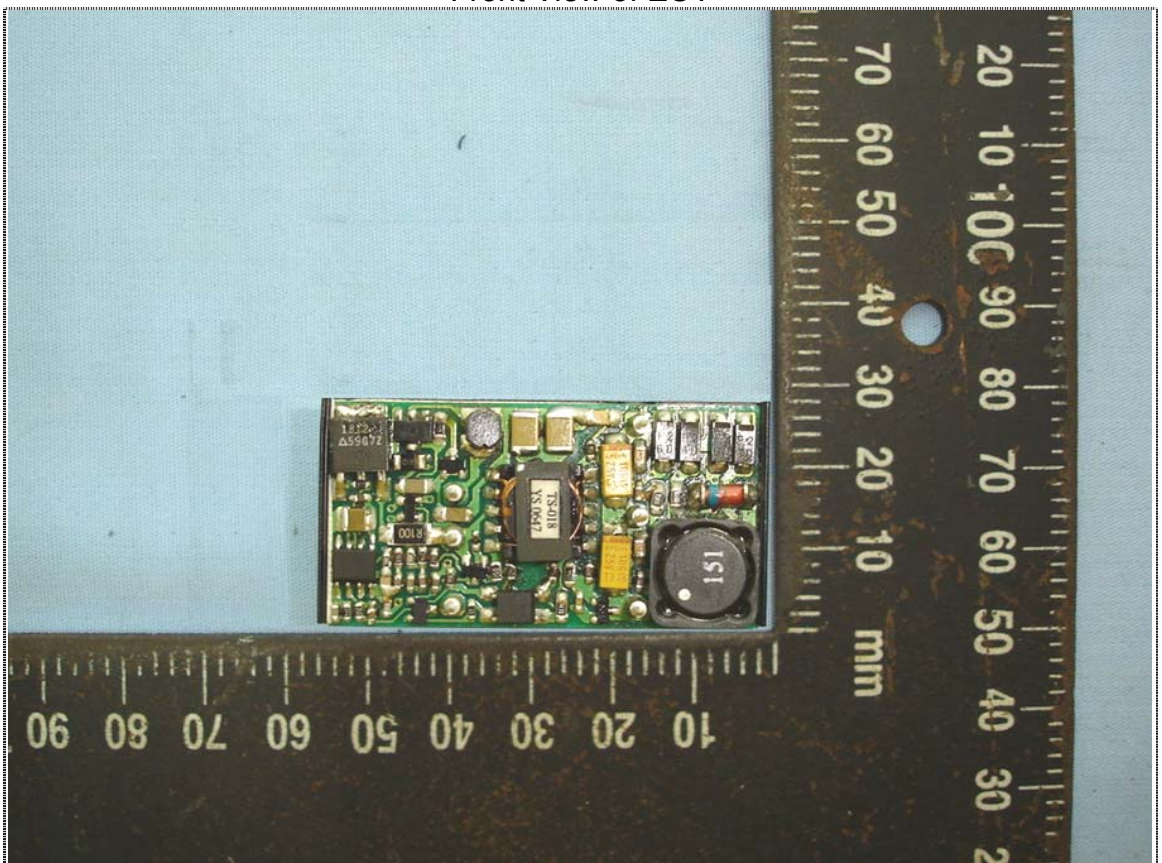

Rear View of EUT

### 14.4 (Model No.: NSD10-48D5)

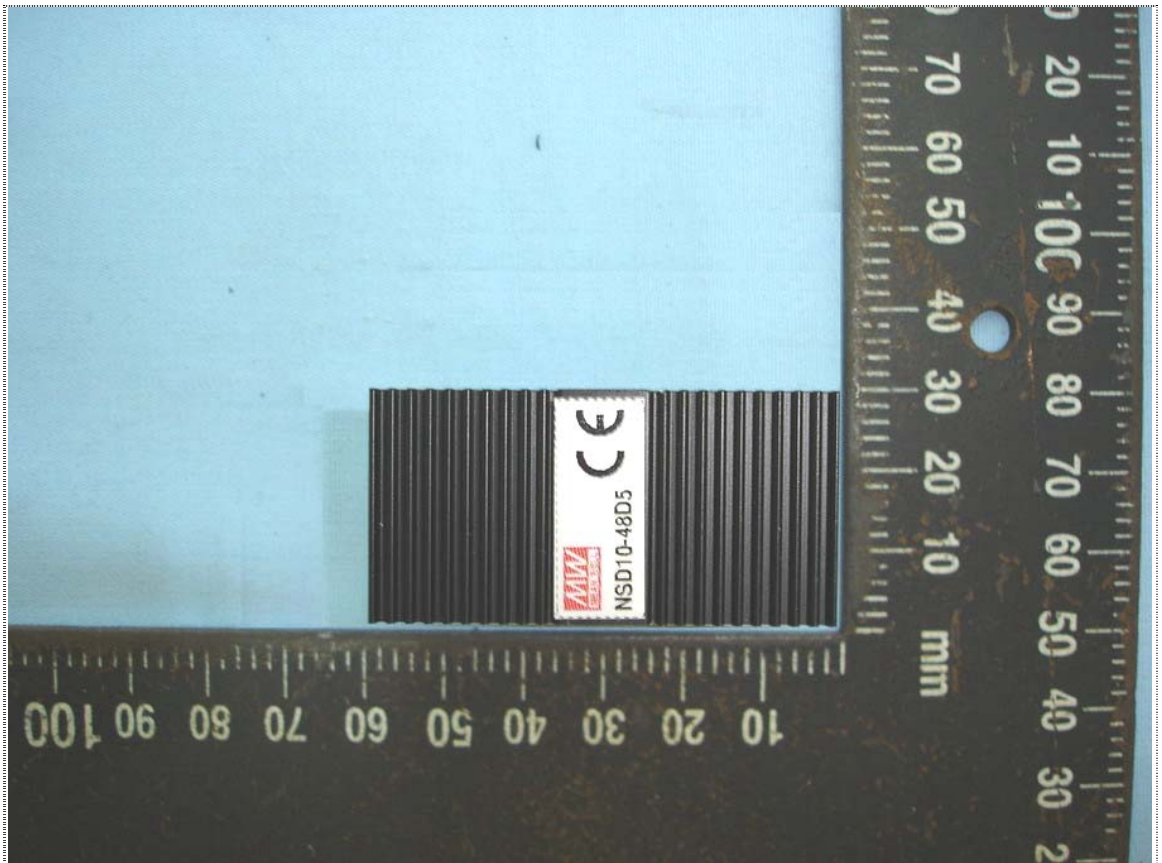

Front View of EUT

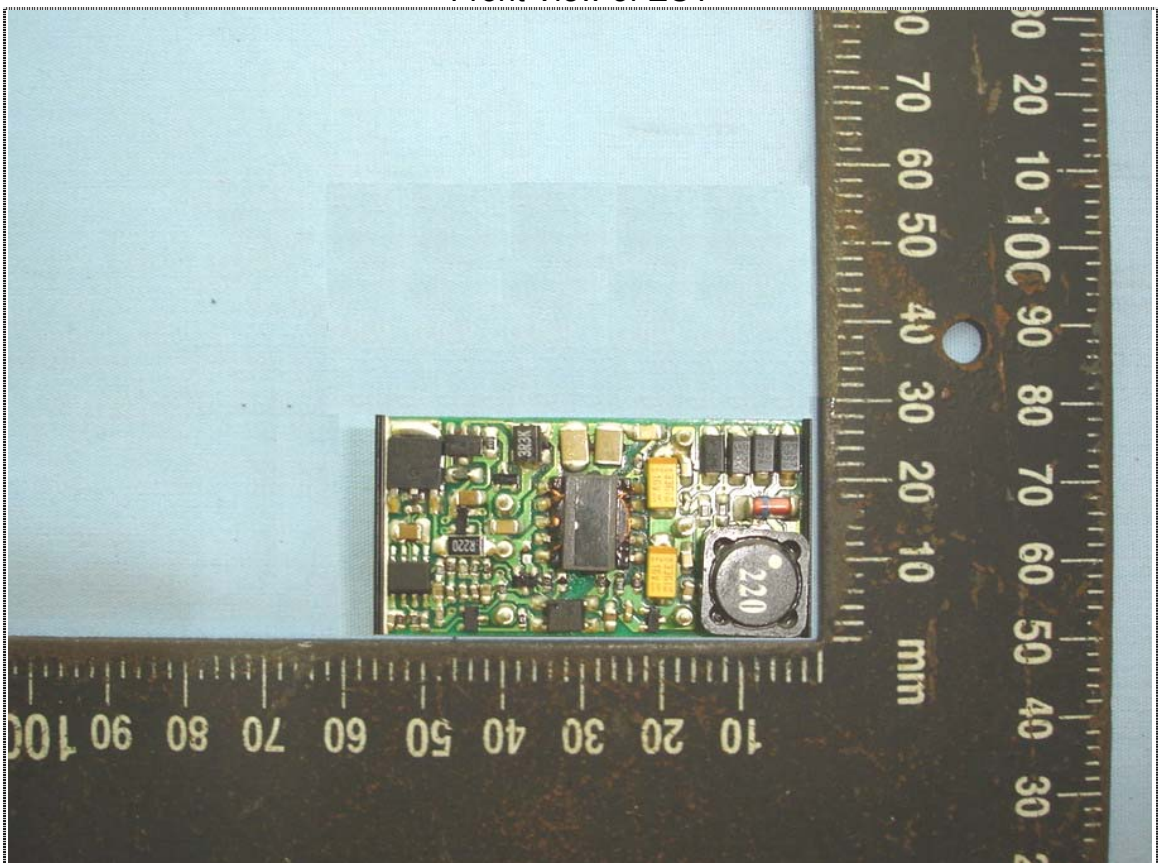

Rear View of EUT



14.5 (Model No.: NSD10-48D12)

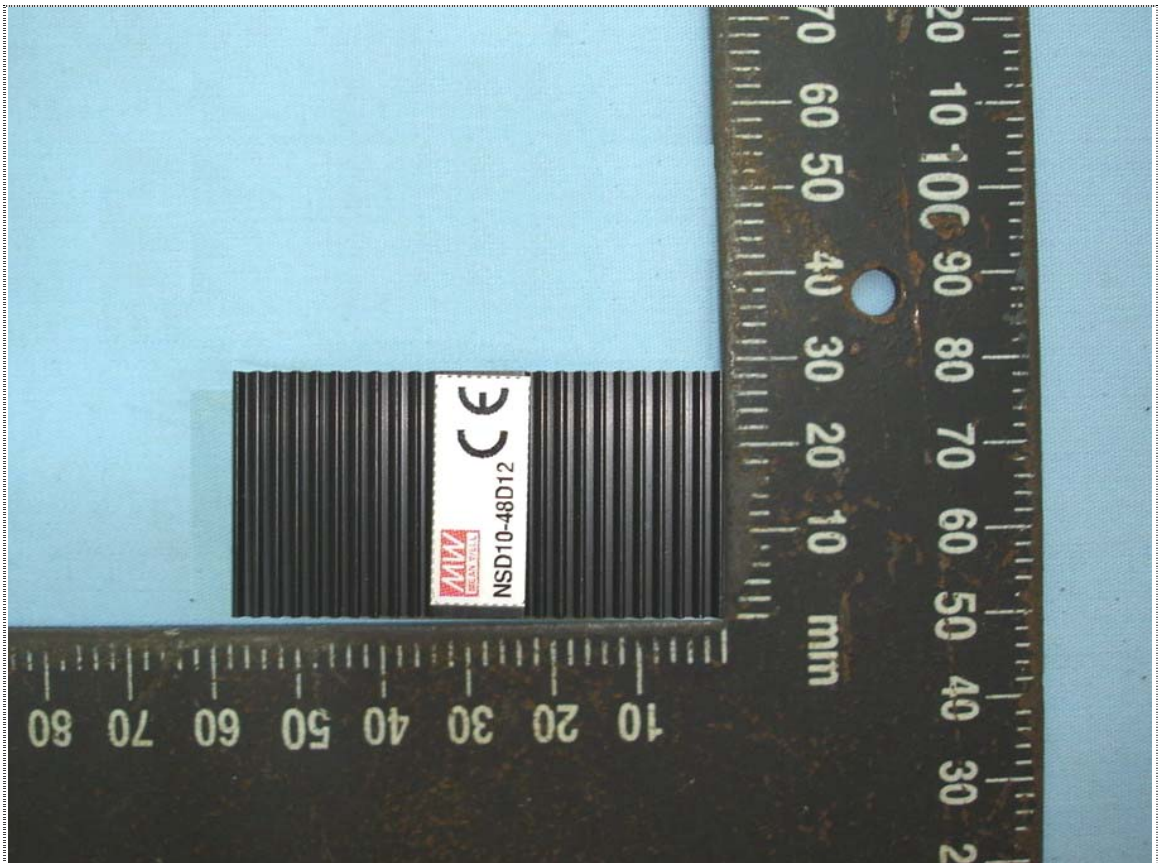

Front View of EUT

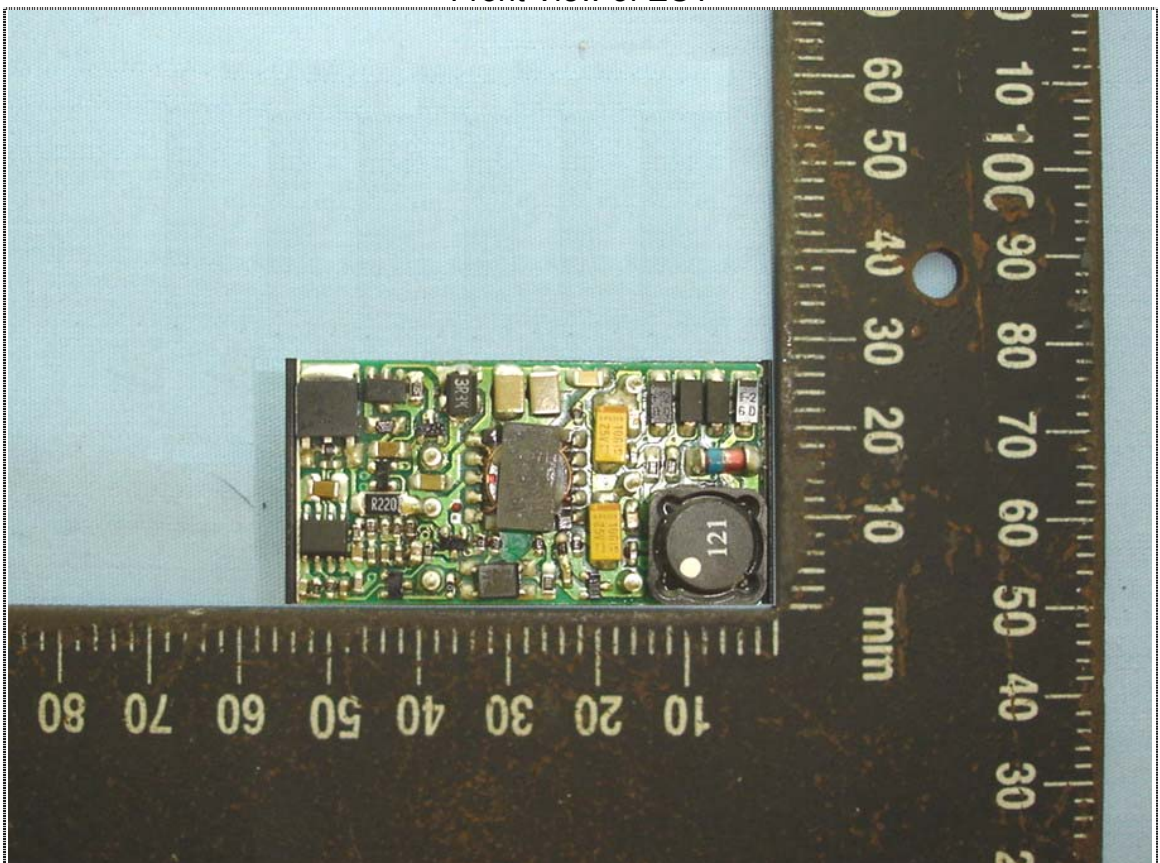

Rear View of EUT

14.6 (Model No.: NSD10-48D15)

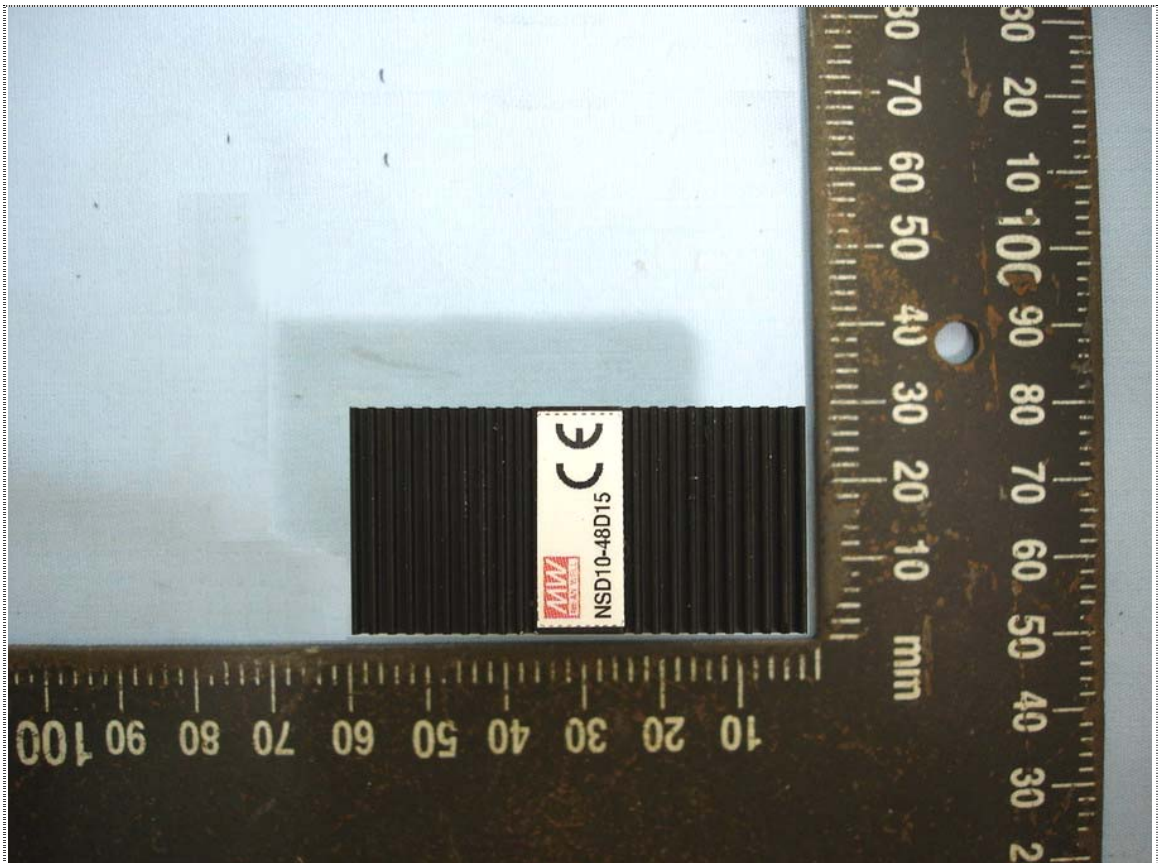

Front View of EUT

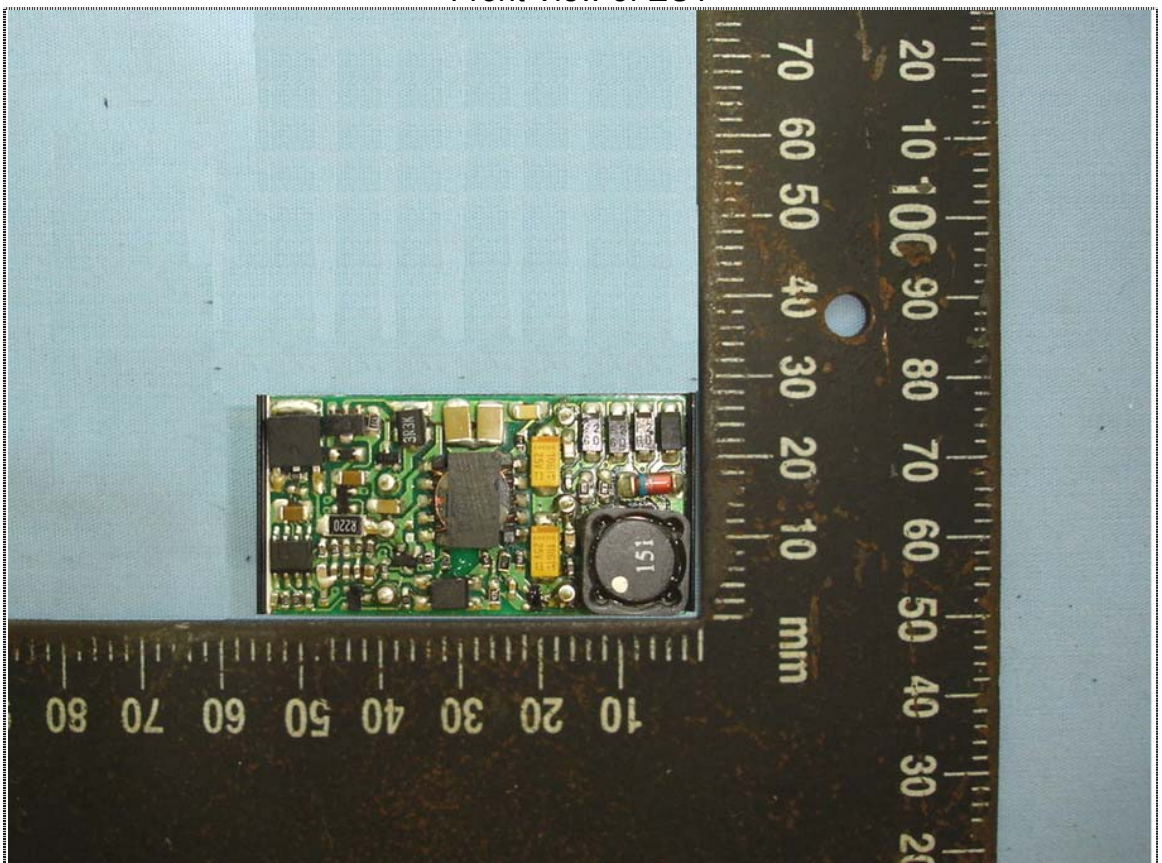

Rear View of EUT

14.7 (Model No.: NSD10-12S3)

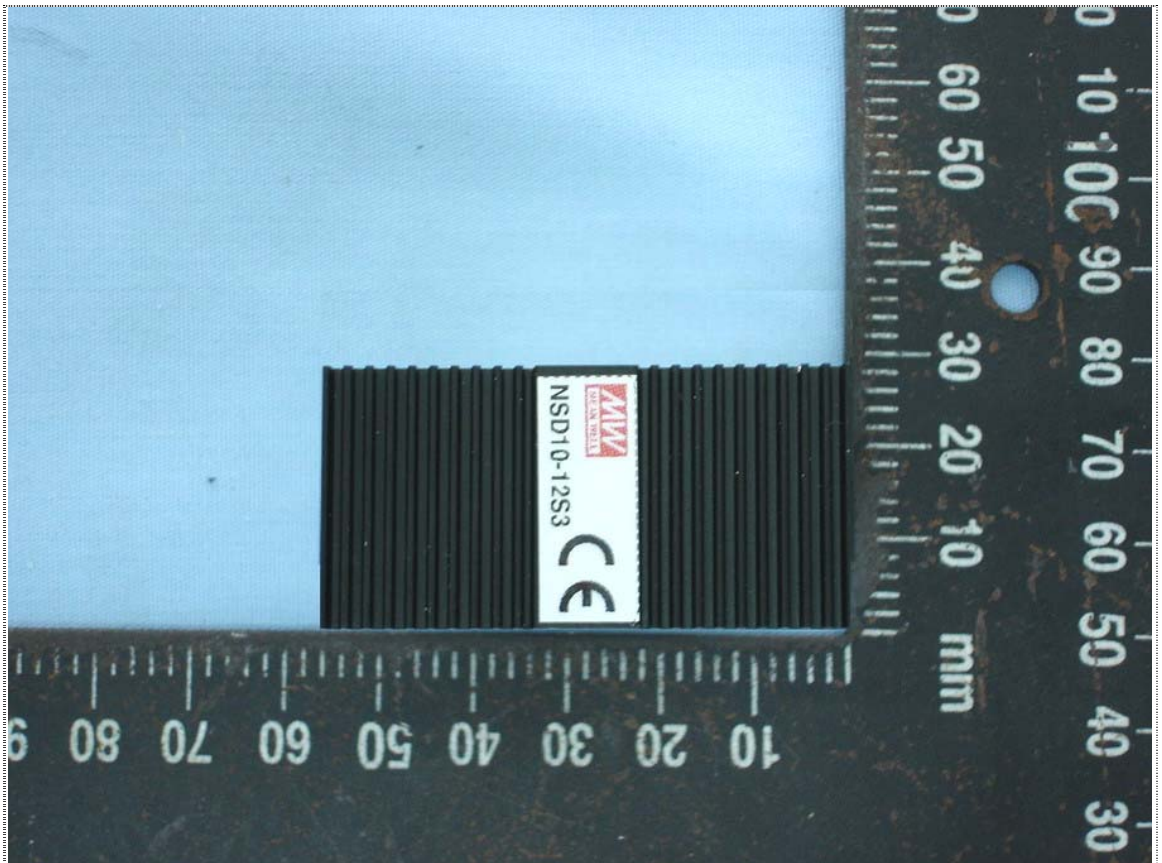

Front View of EUT

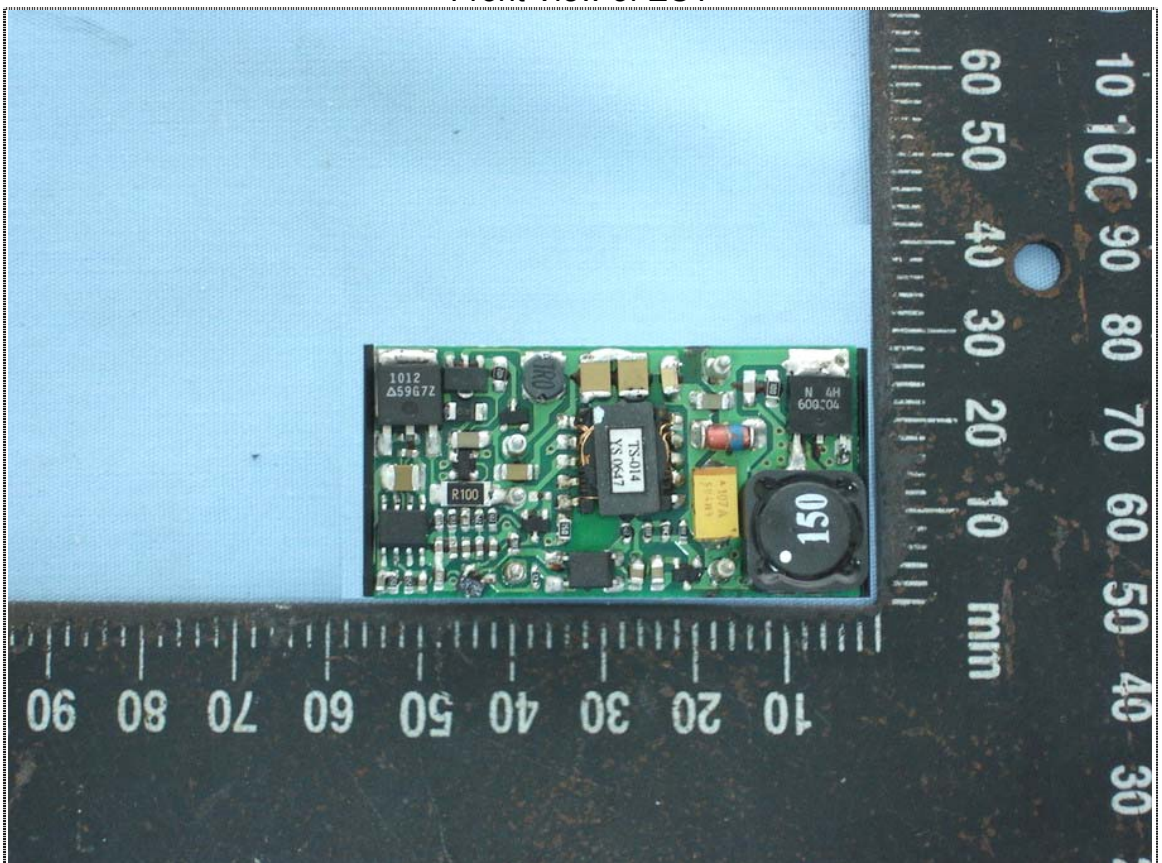

Rear View of EUT

14.8 (Model No.: NSD10-12S5)

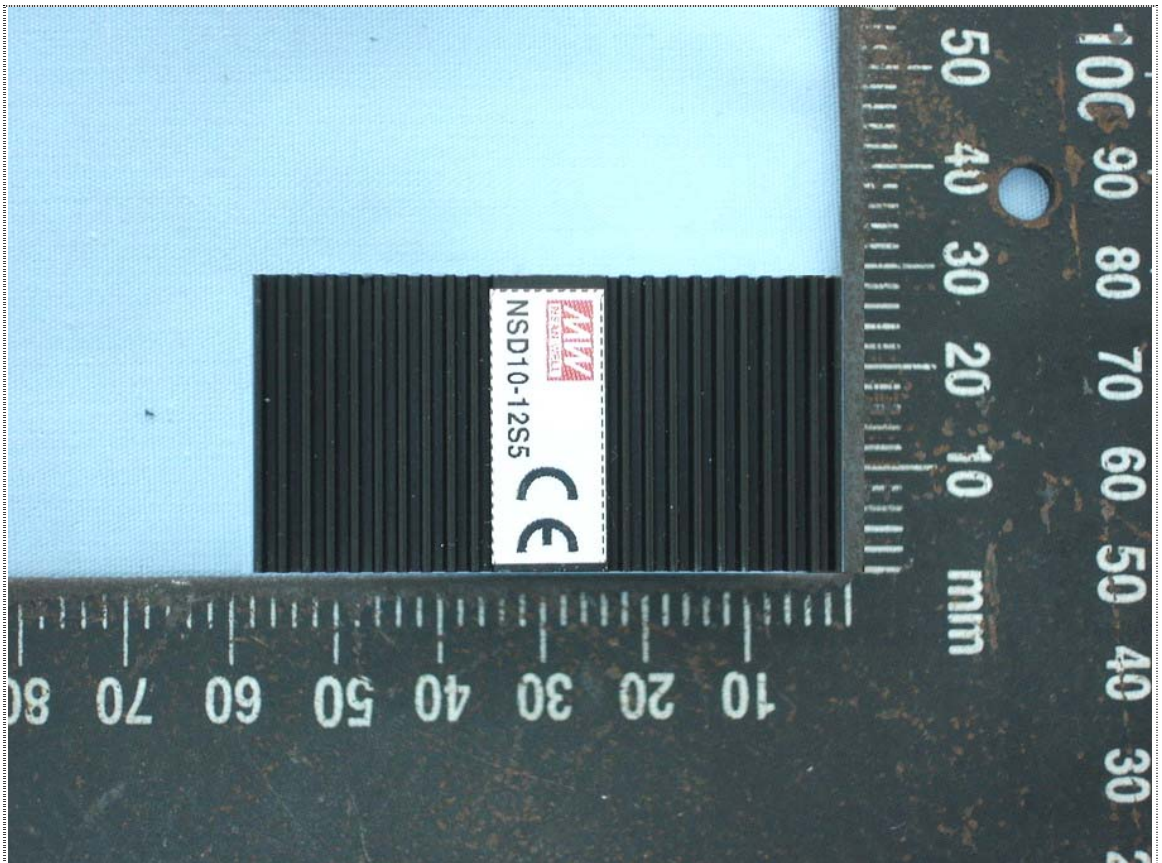

Front View of EUT

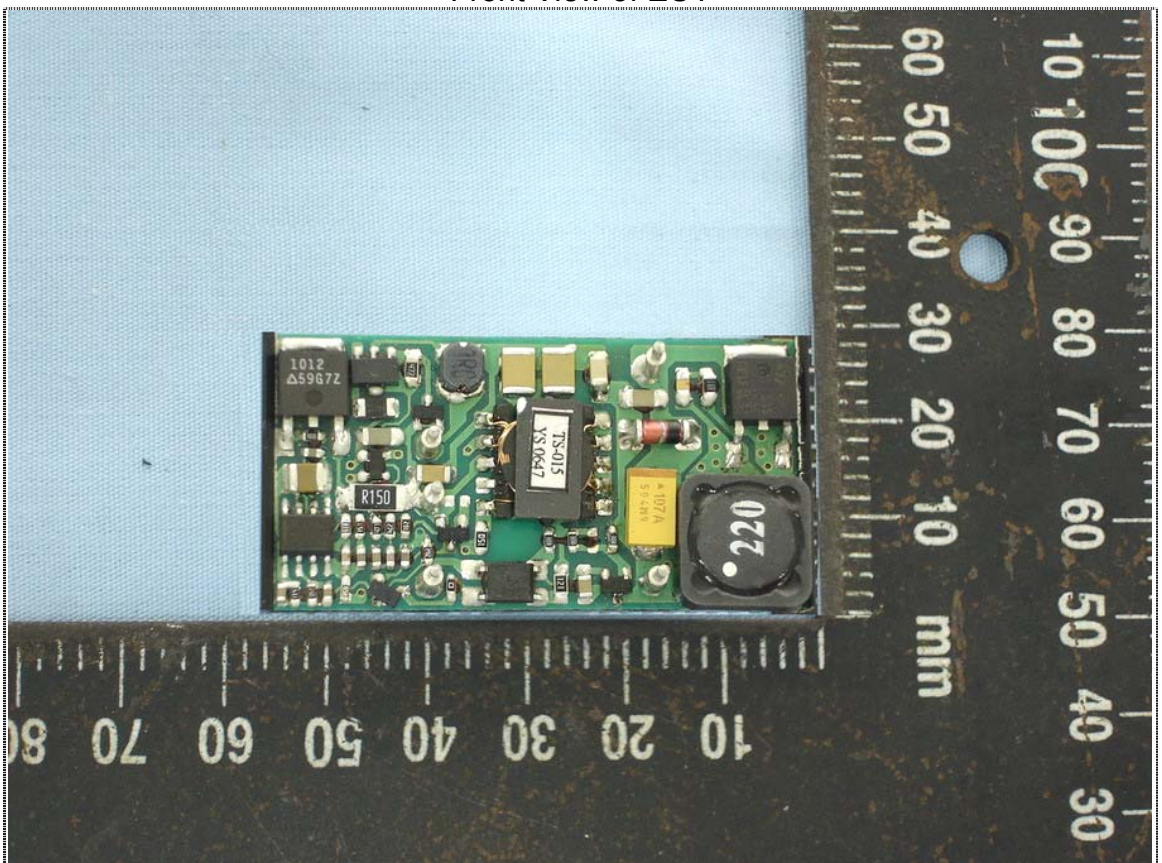

Rear View of EUT

14.9 (Model No.: NSD10-12S9)

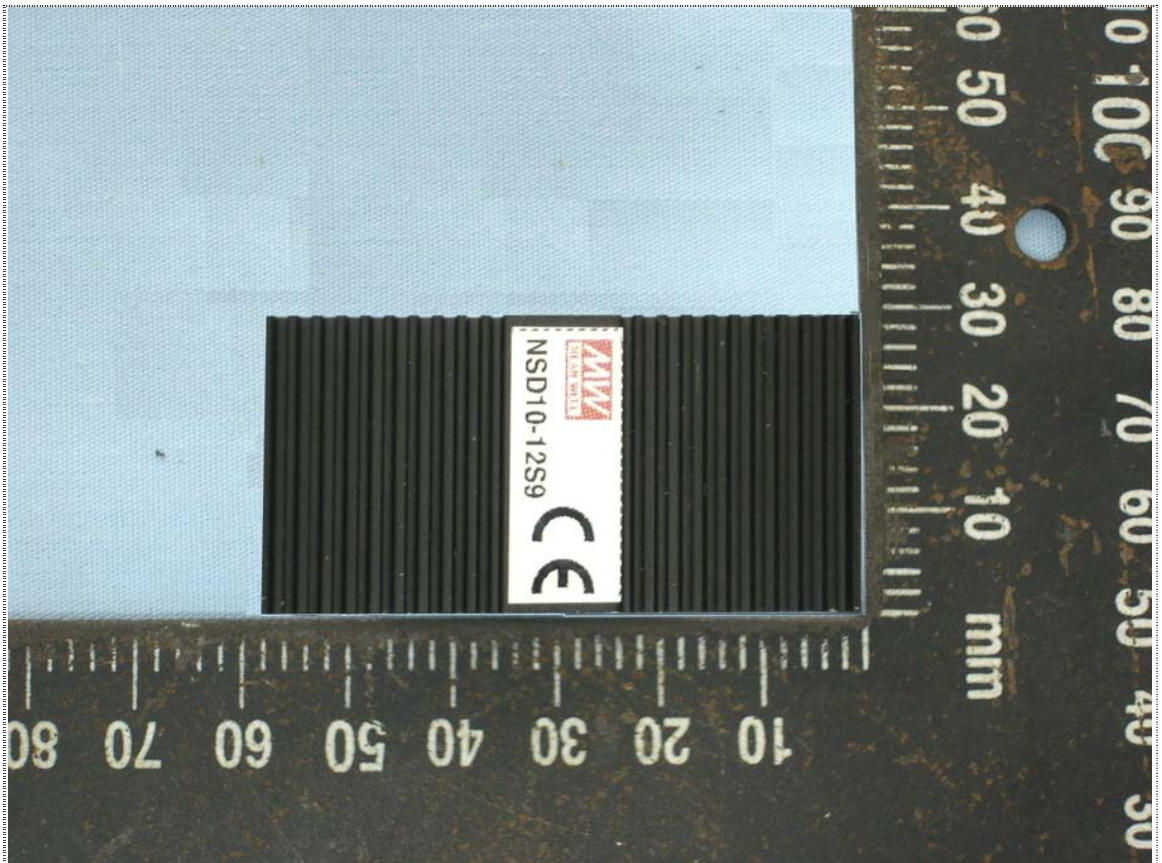

Front View of EUT

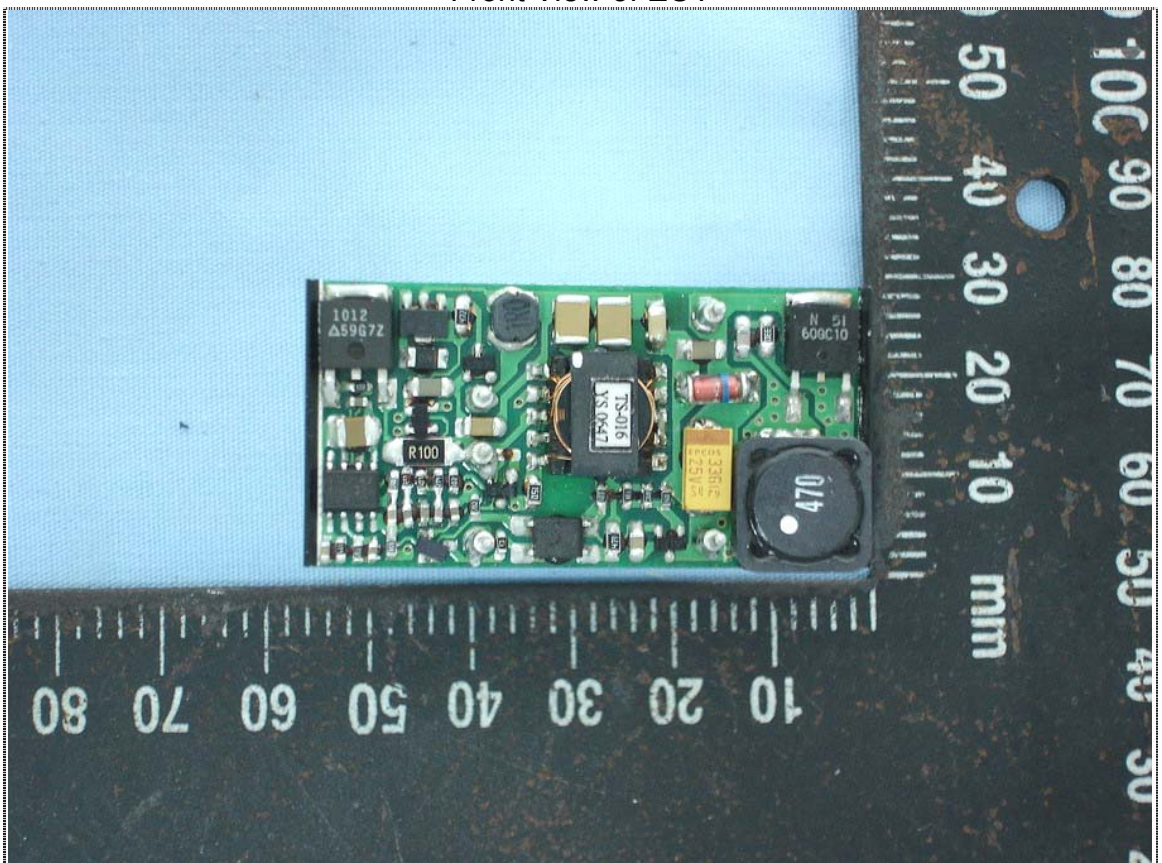

Rear View of EUT

14.10 (Model No.: NSD10-12S12)

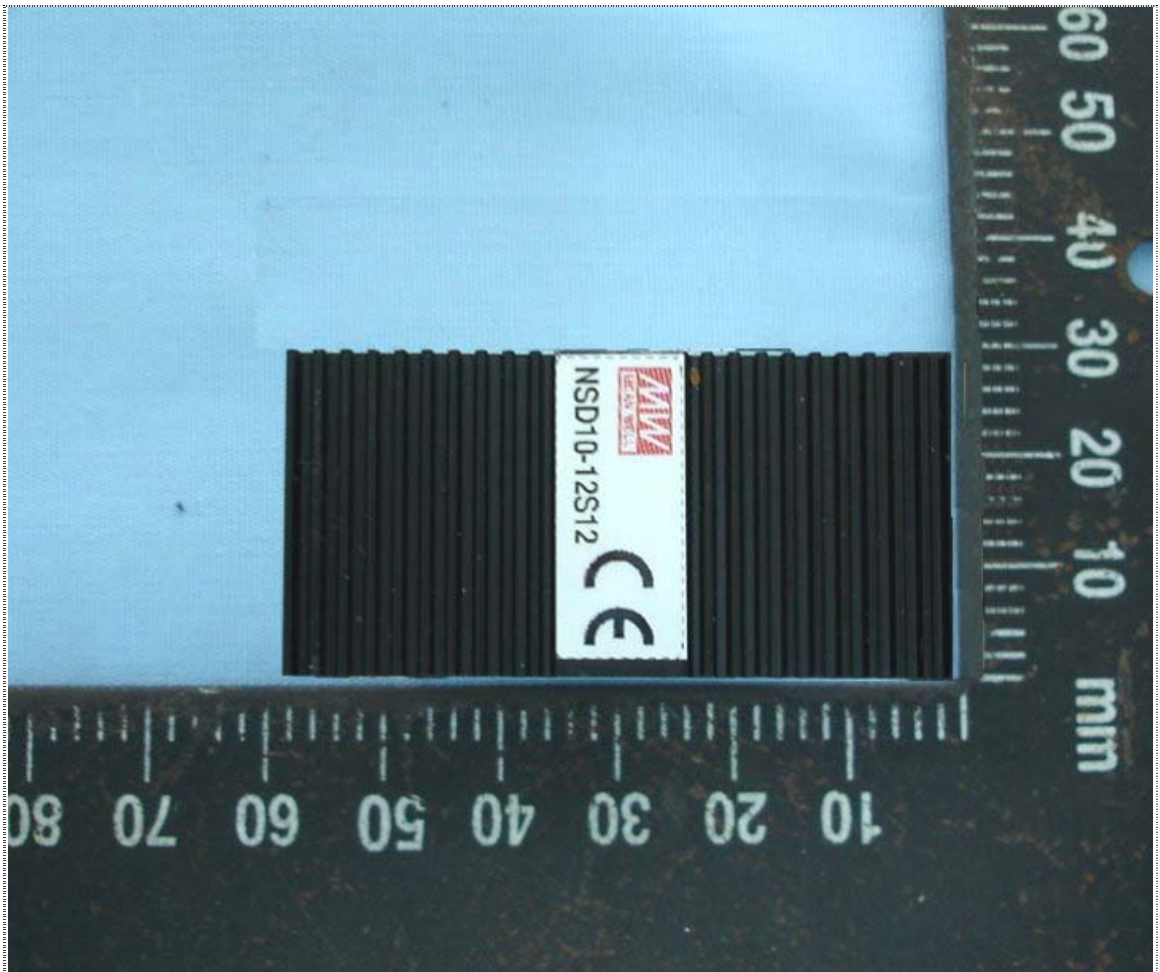

Front View of EUT

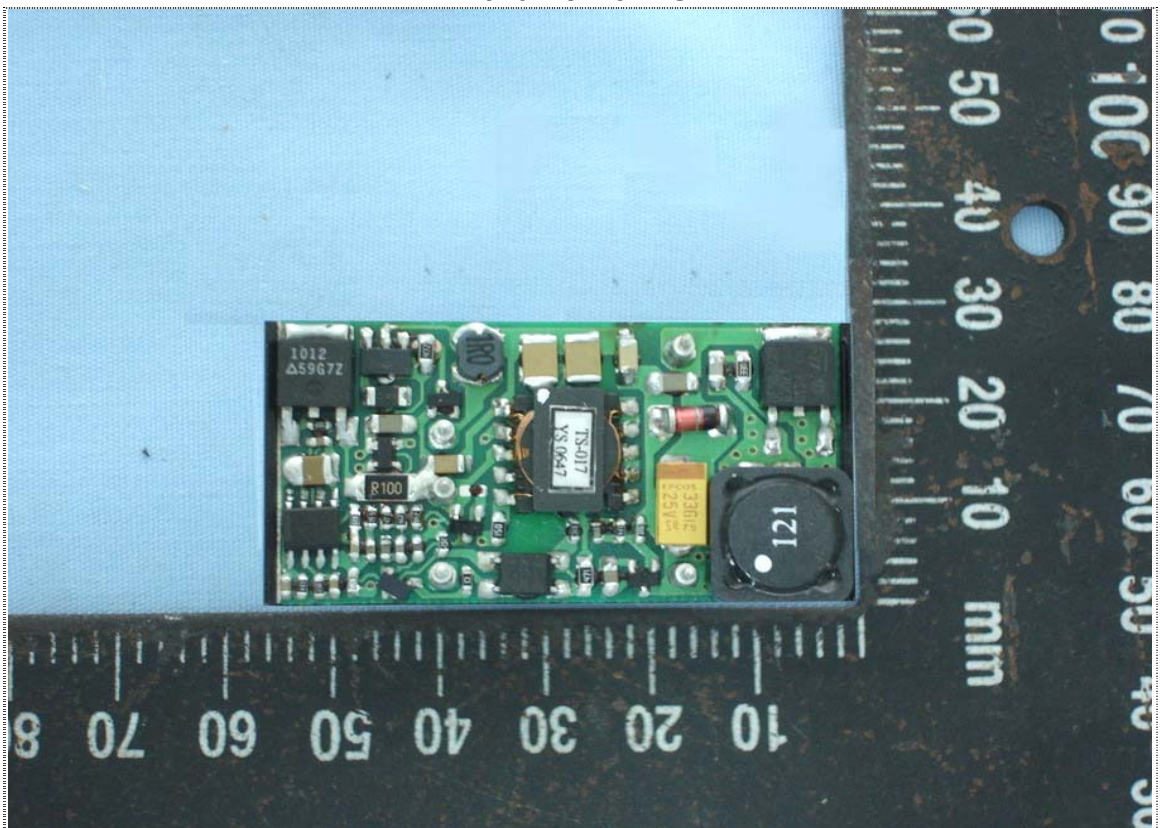

Rear View of EUT

14.11 (Model No.: NSD10-12S15)

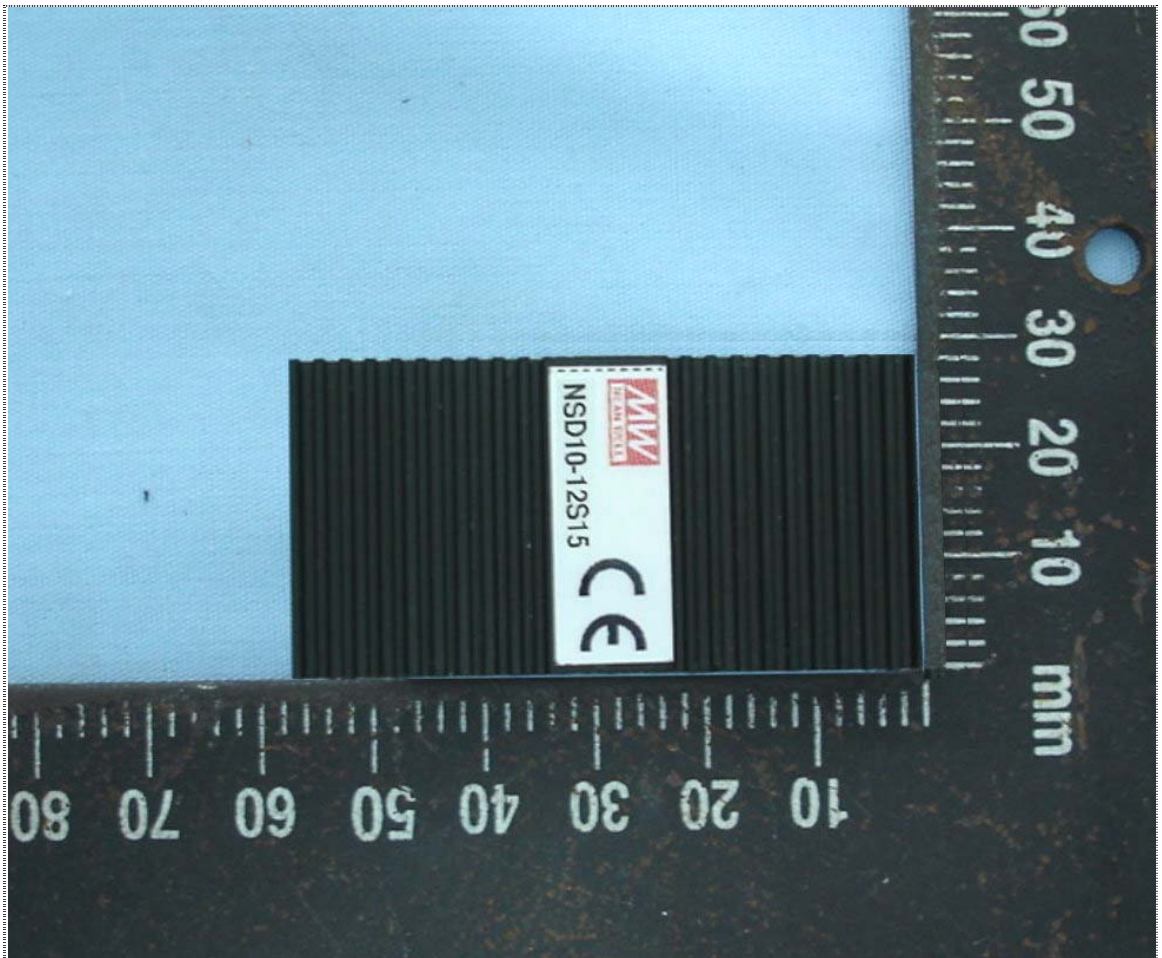

Front View of EUT

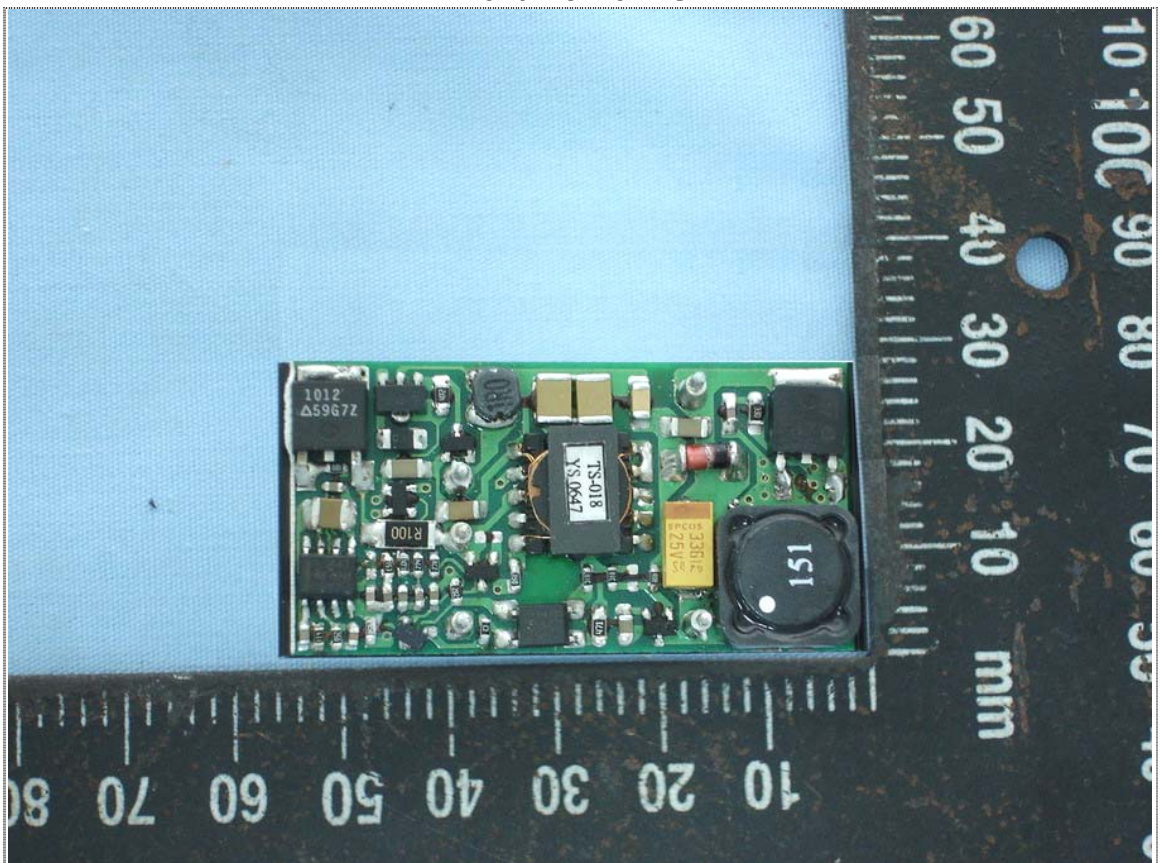

Rear View of EUT

14.12 (Model No.: NSD10-48S3)

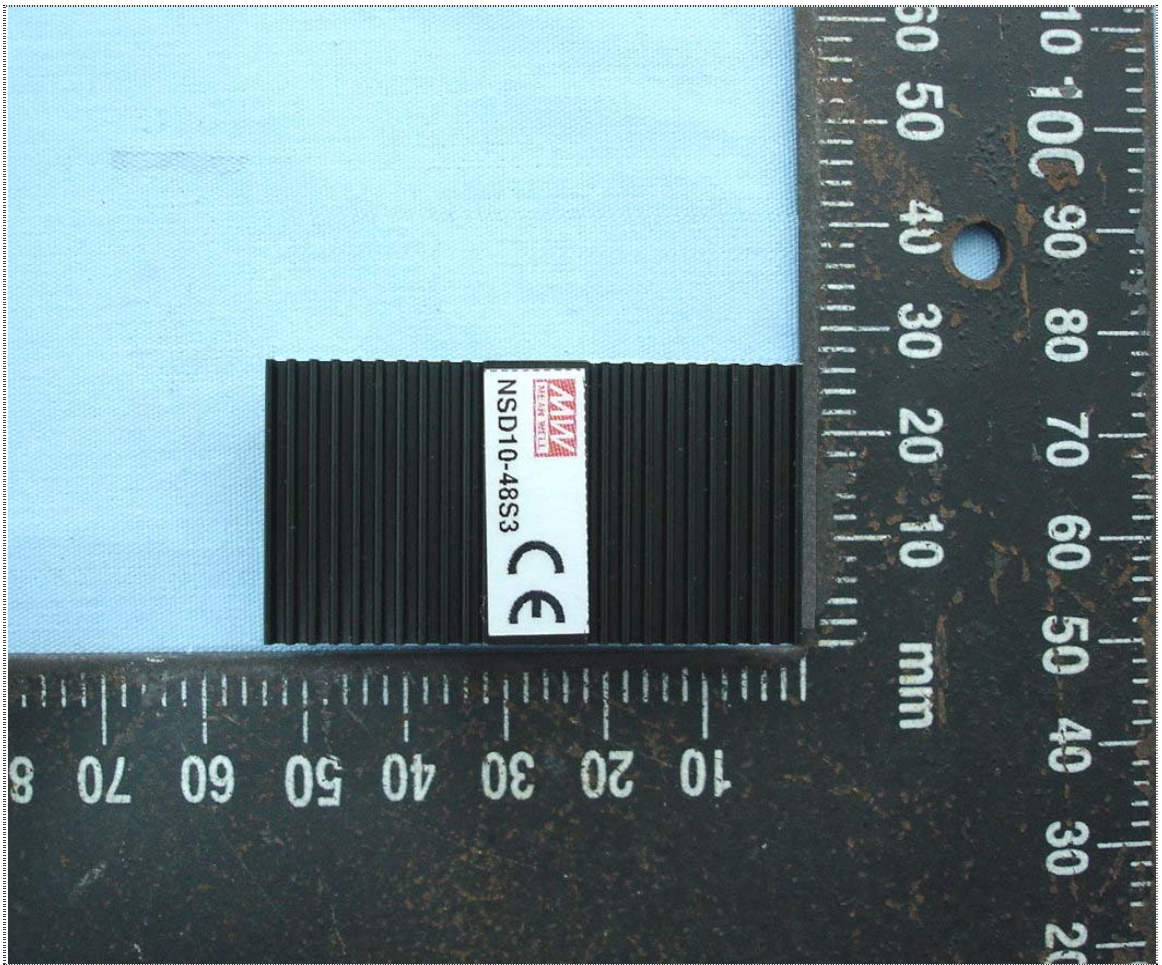

Front View of EUT

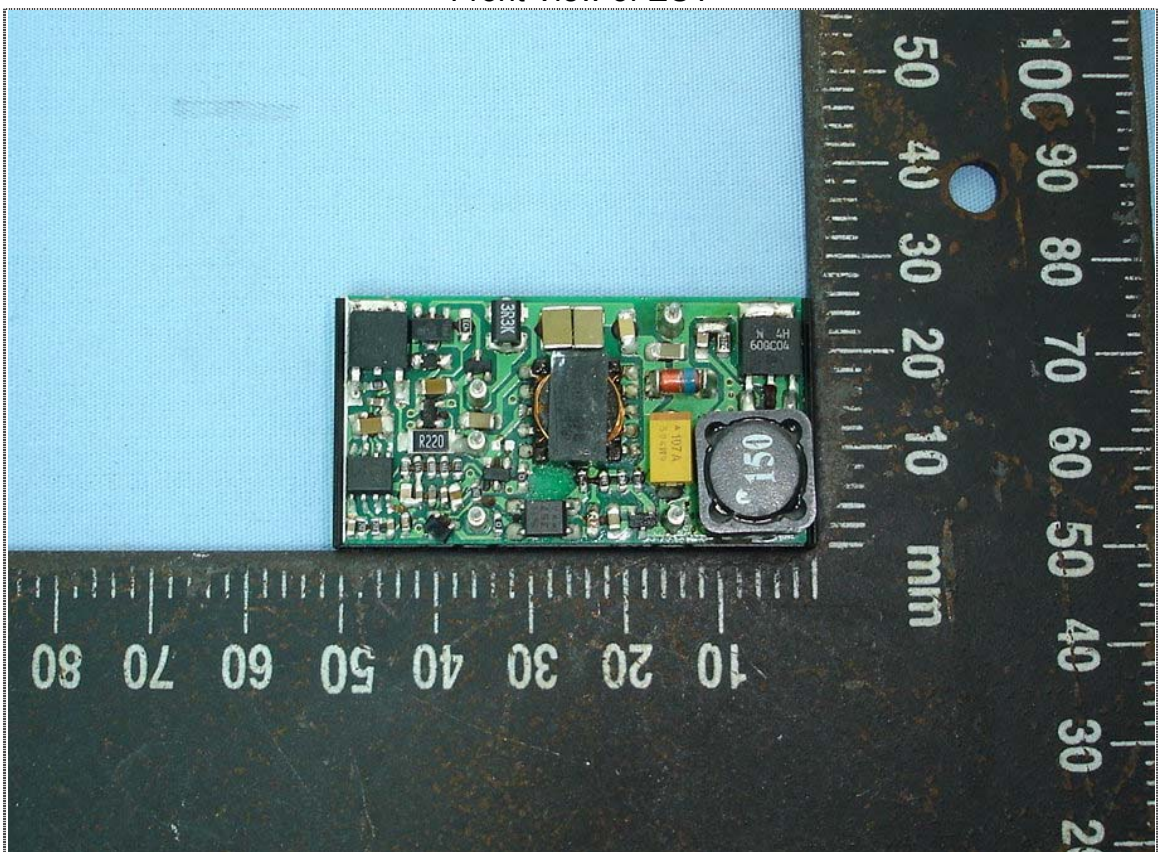

Rear View of EUT



14.13 (Model No.: NSD10-48S5)

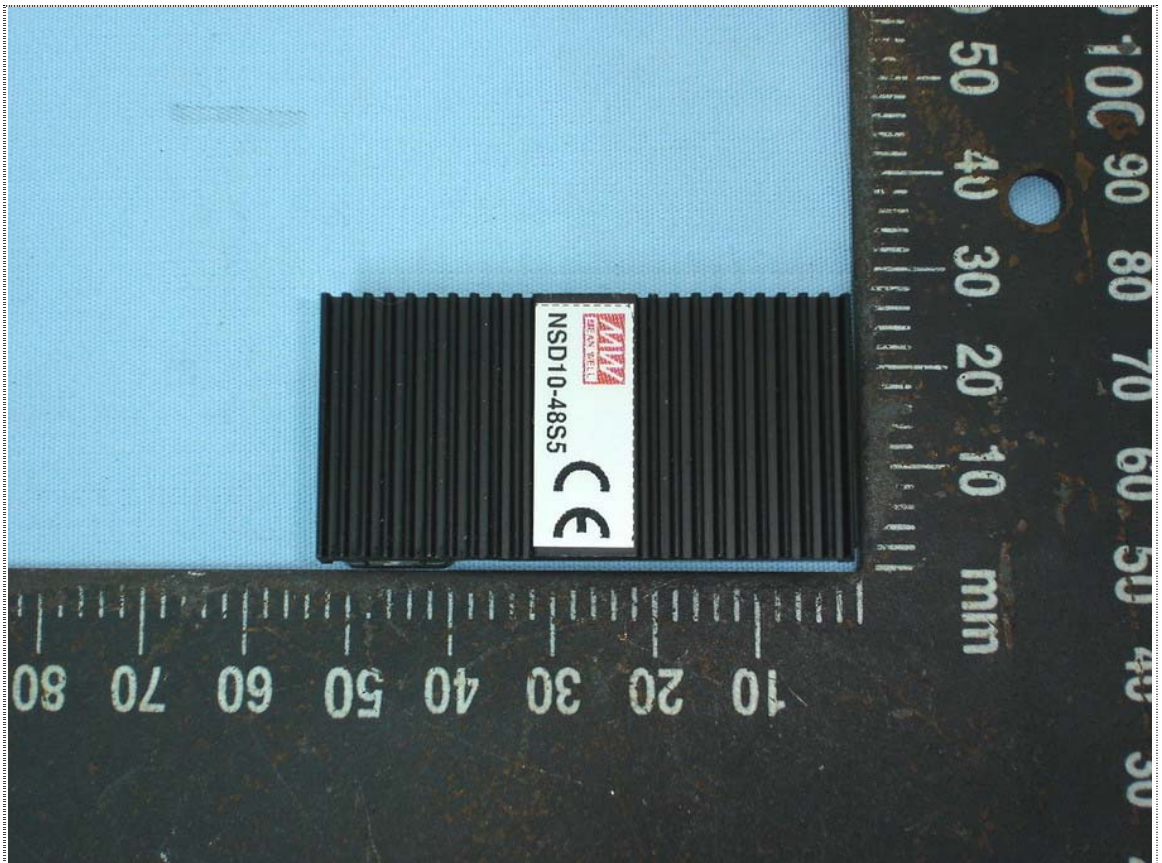

Front View of EUT

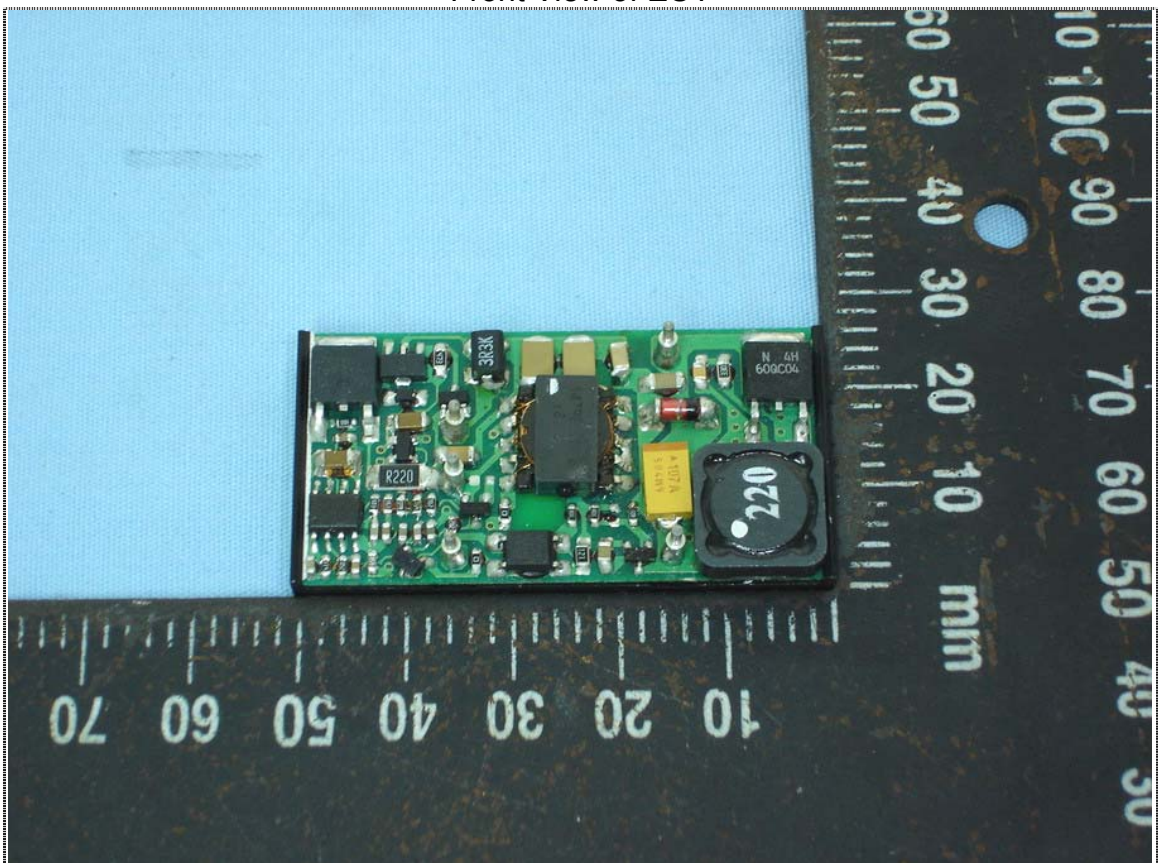

Rear View of EUT

14.14 (Model No.: NSD10-48S9)

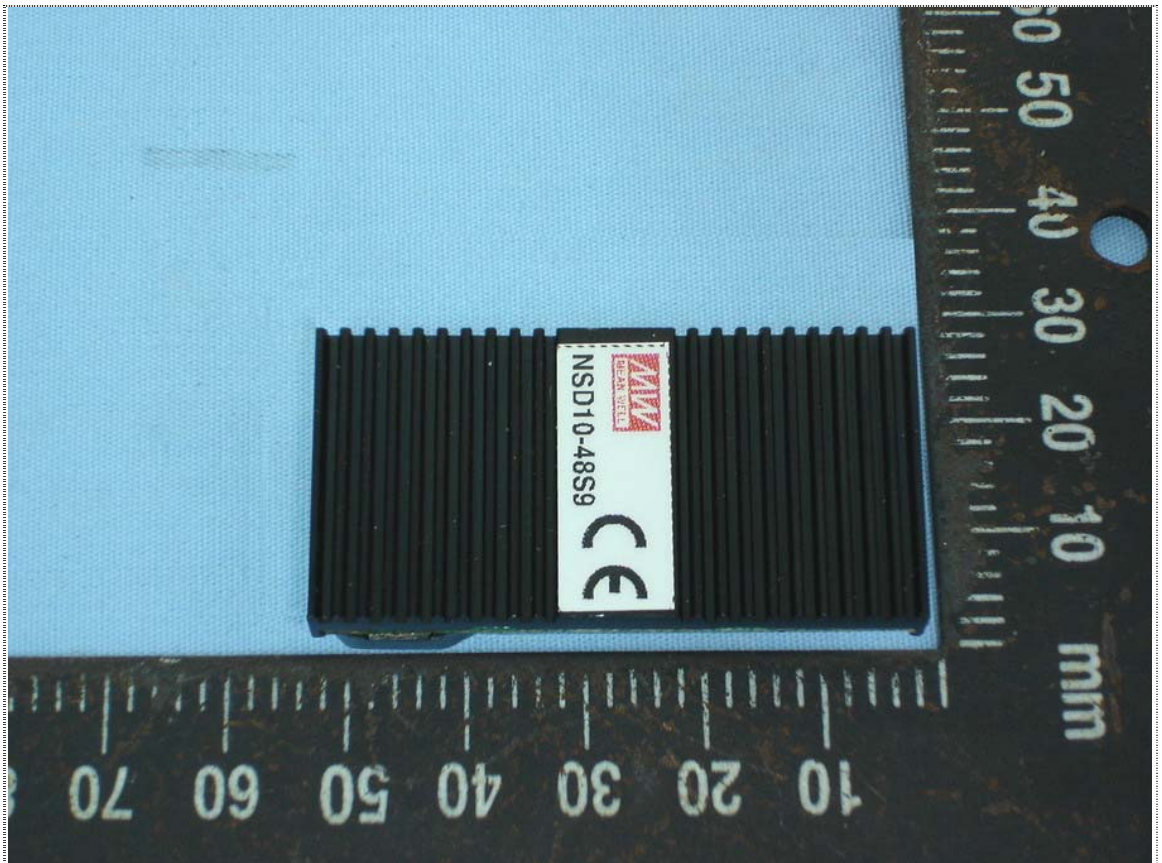

Front View of EUT

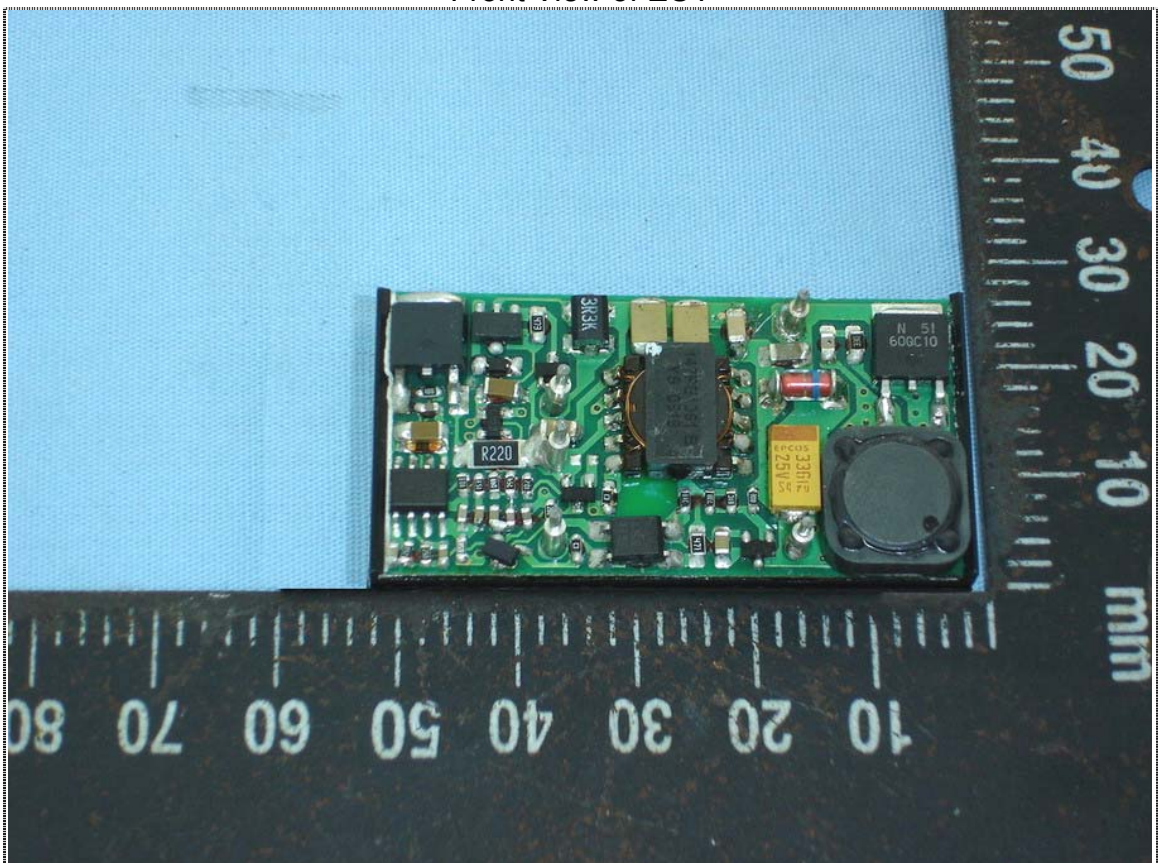

Rear View of EUT

14.15 (Model No.: NSD10-48S12)

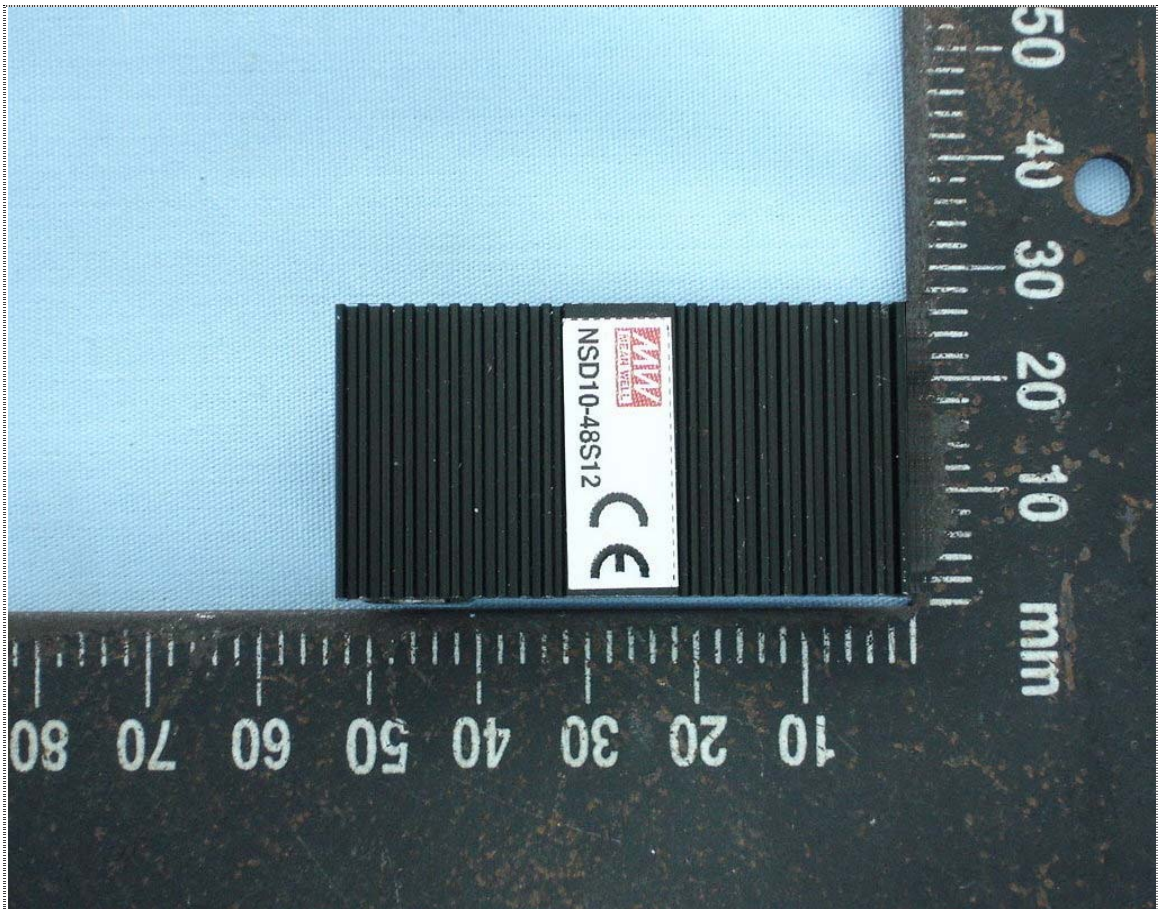

Front View of EUT

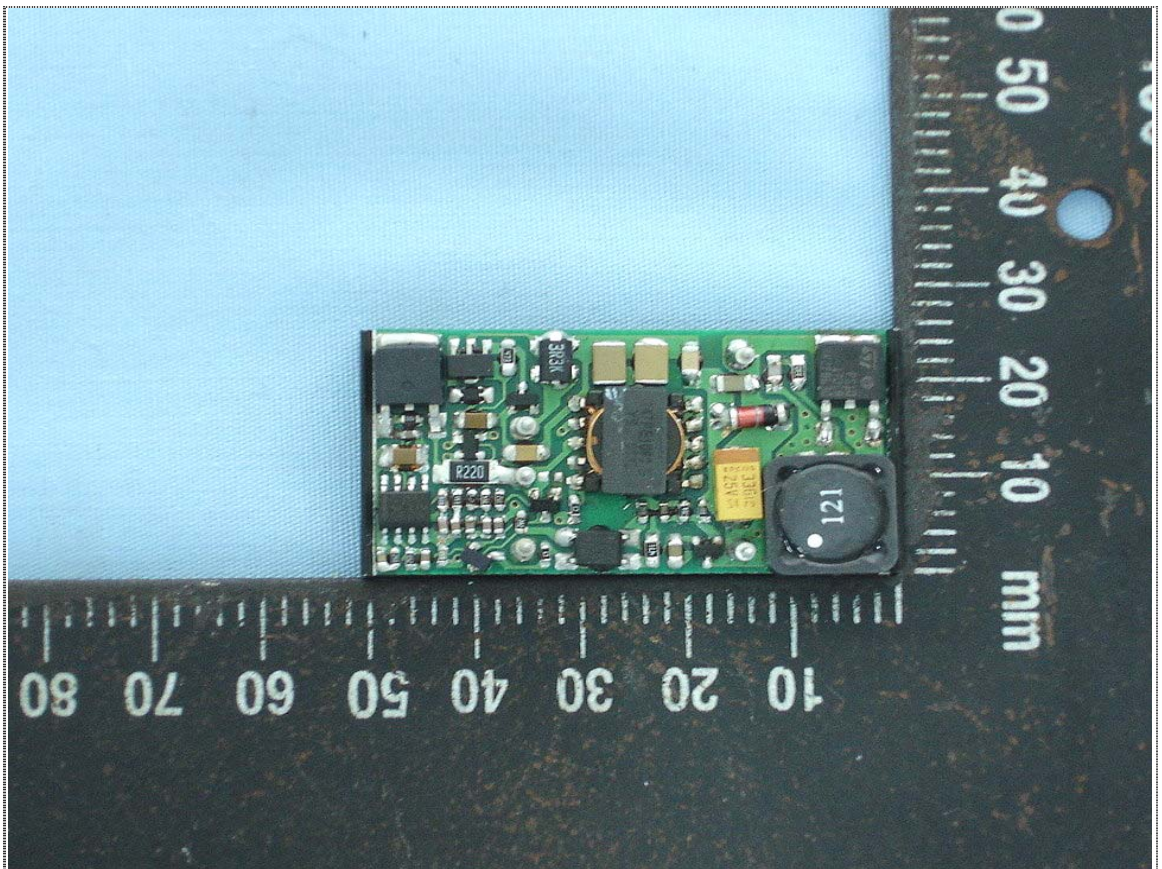

Rear View of EUT

14.16 (Model No.: NSD10-48S15)

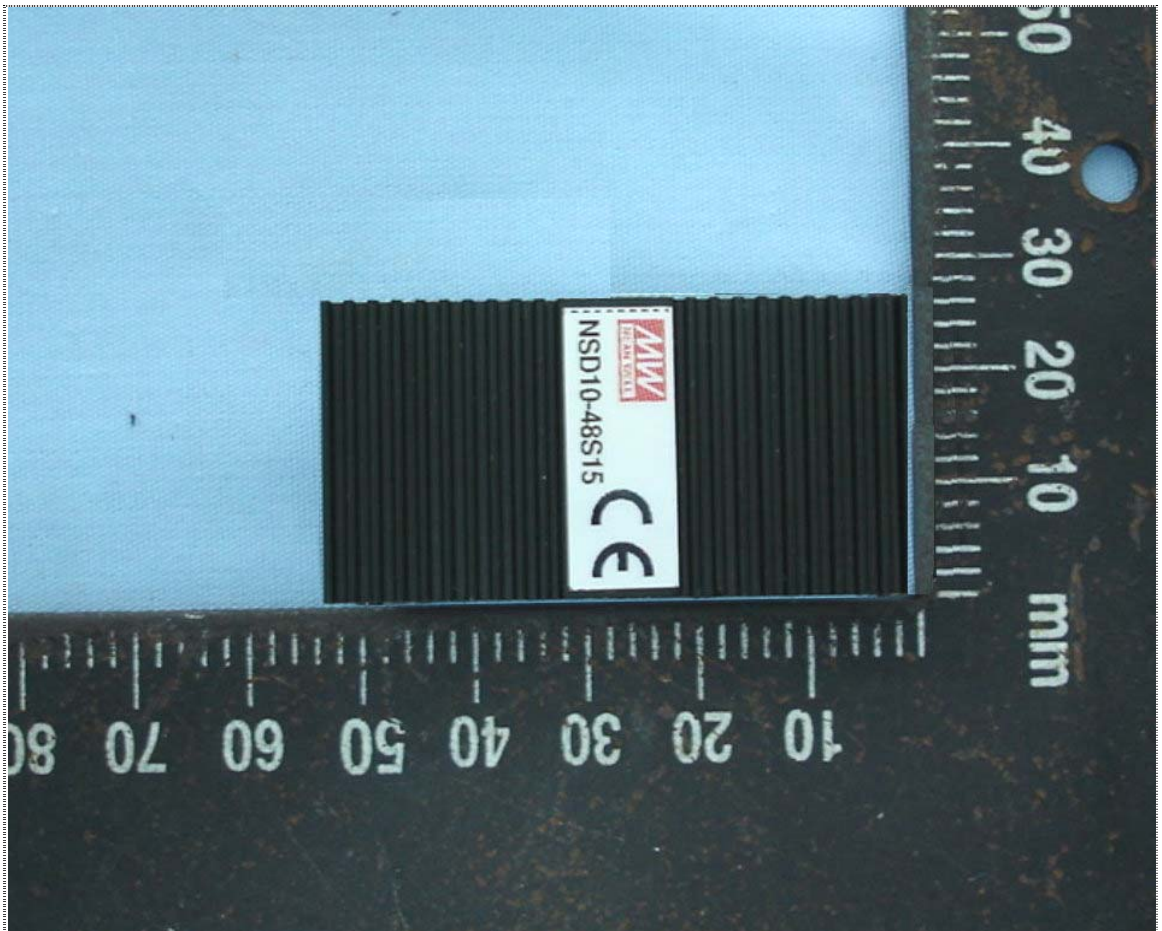

Front View of EUT

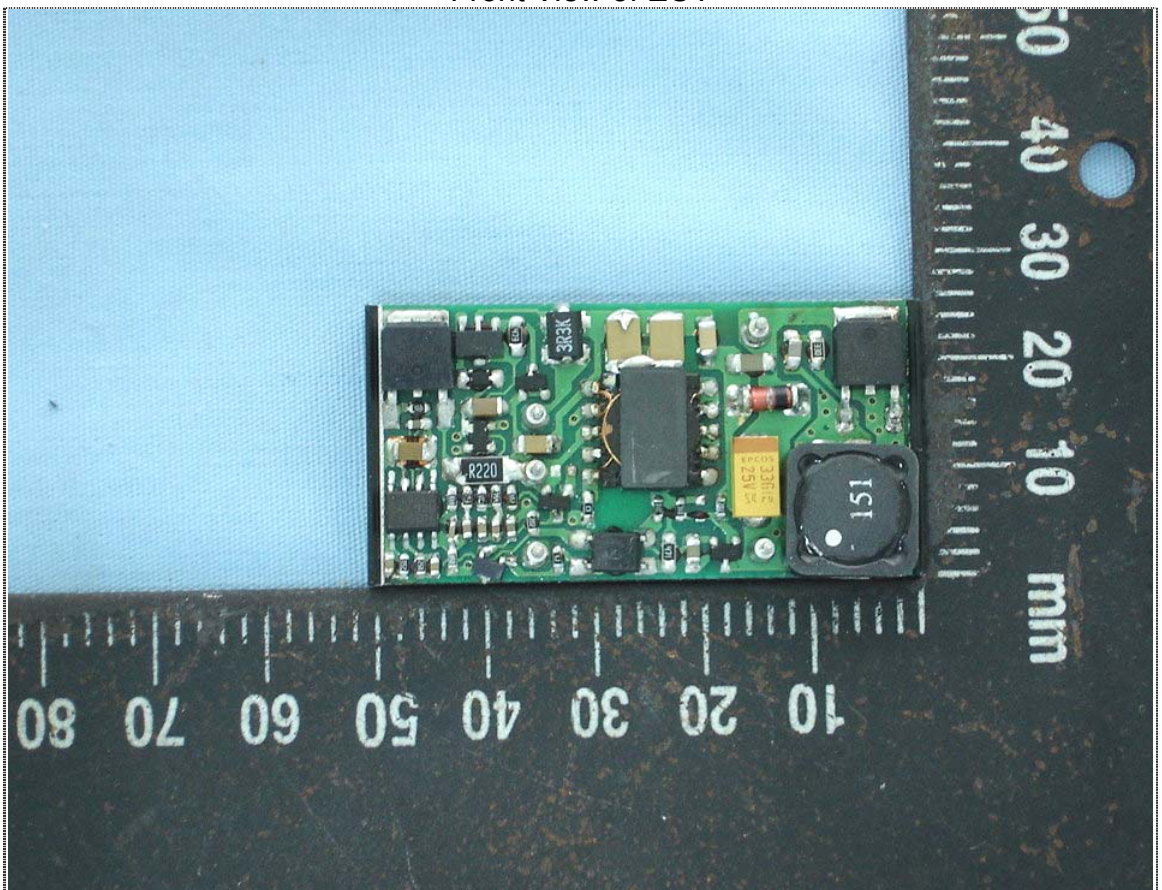

Rear View of EUT

### 15 Photographs of PCB (For NSD10-xDz Series)

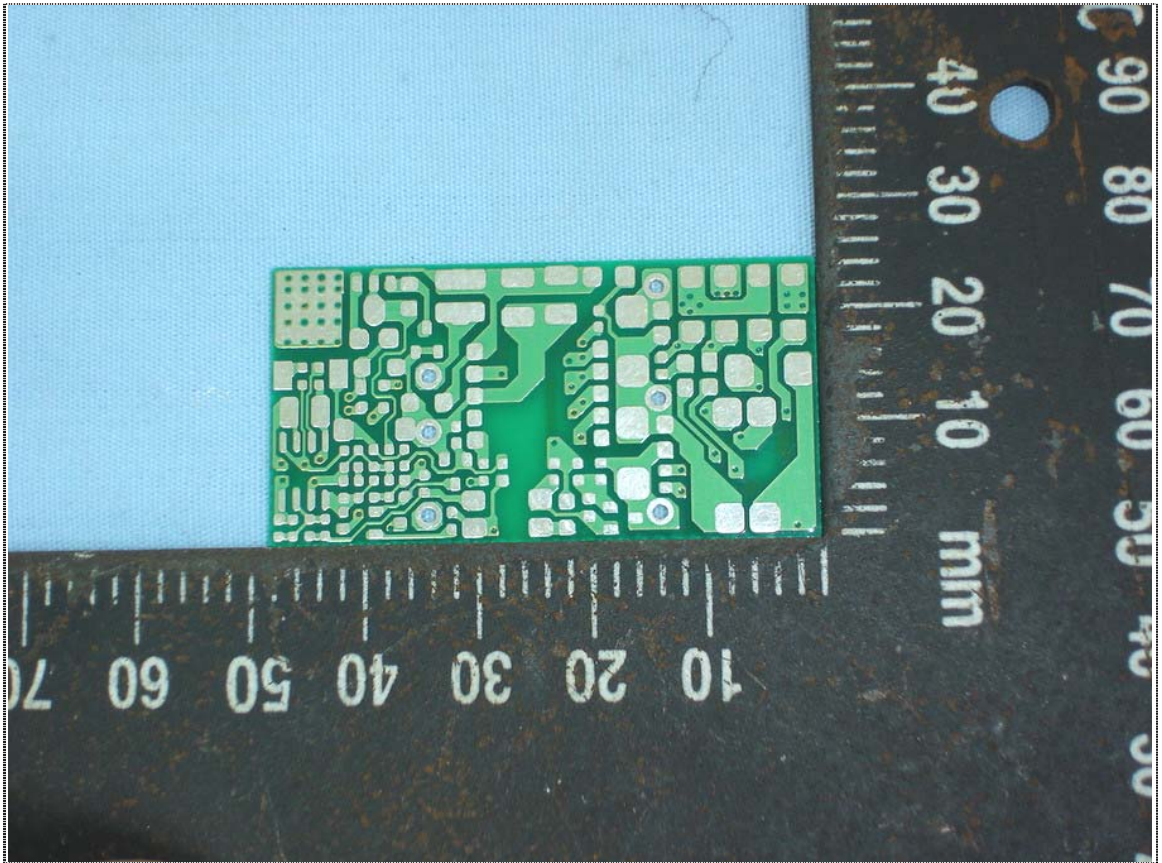

Component View of PCB

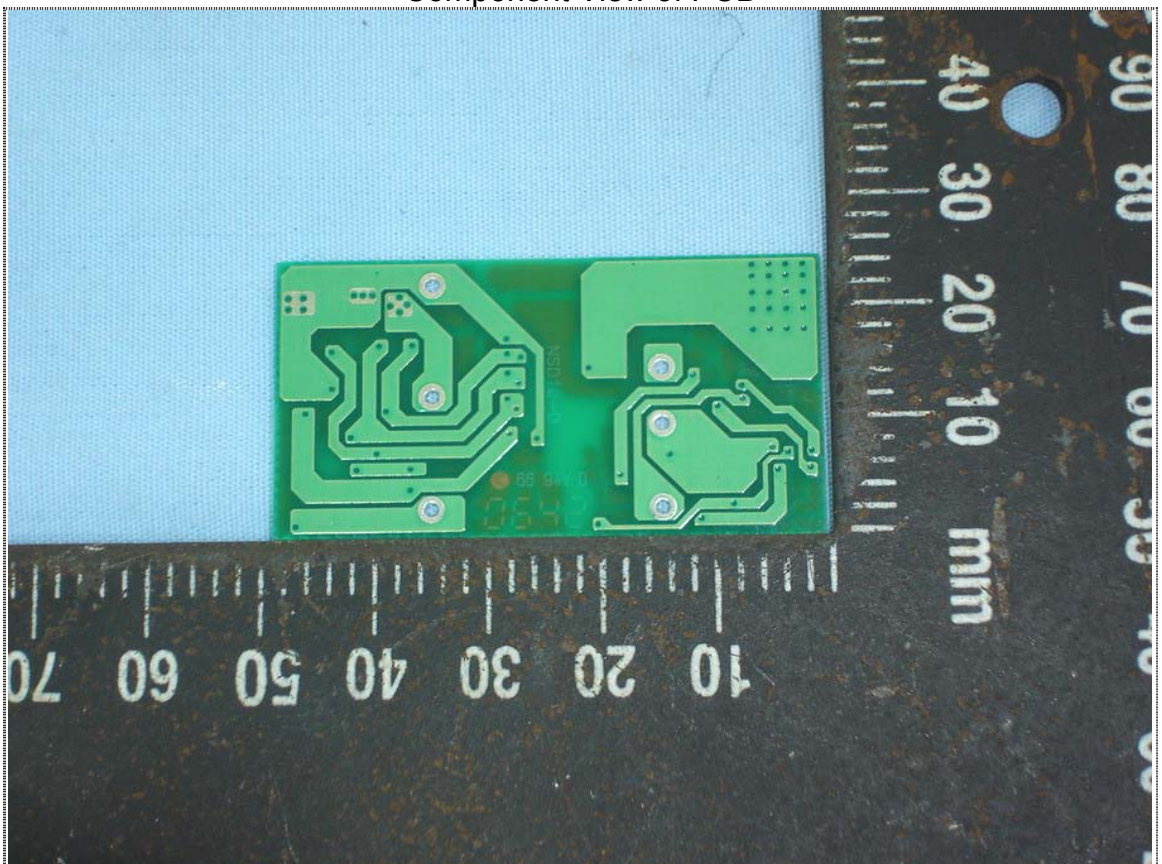

Solder View of PCB

### 16 Photographs of PCB (For NSD10-xSz Series)

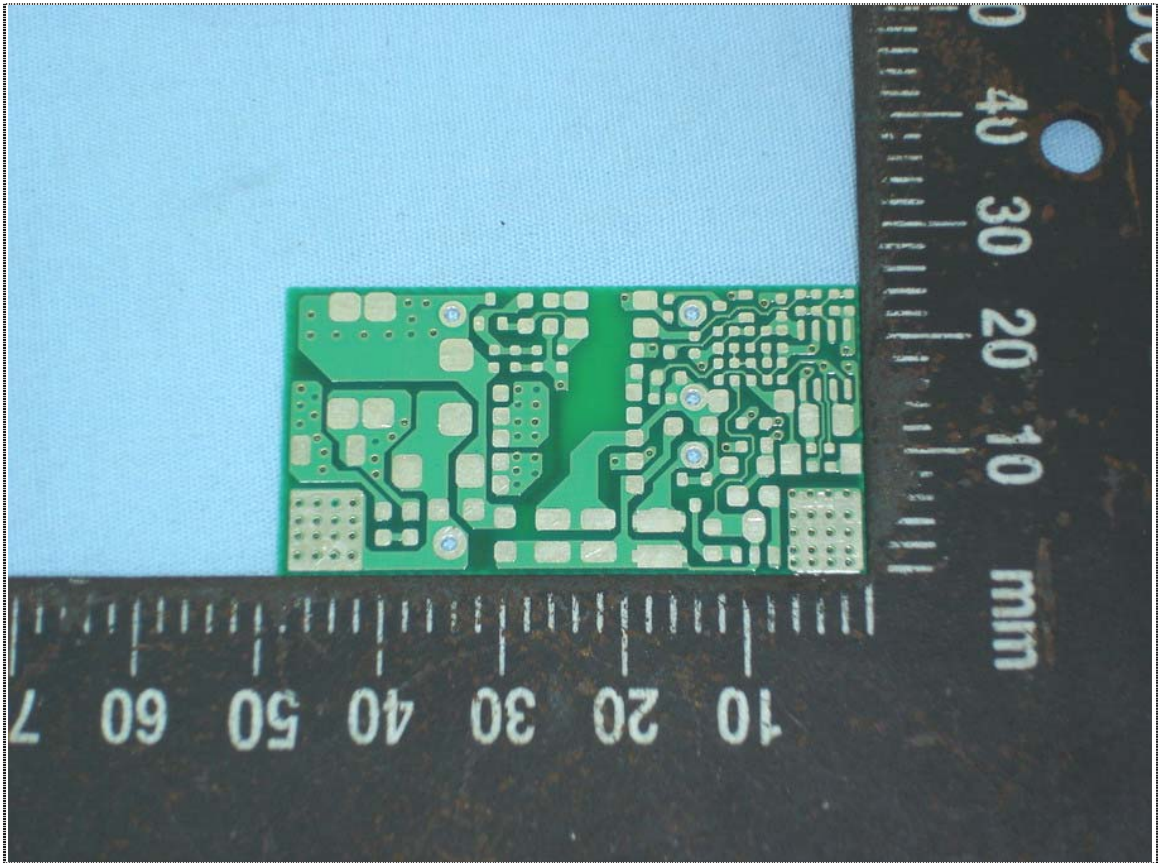

Component View of PCB

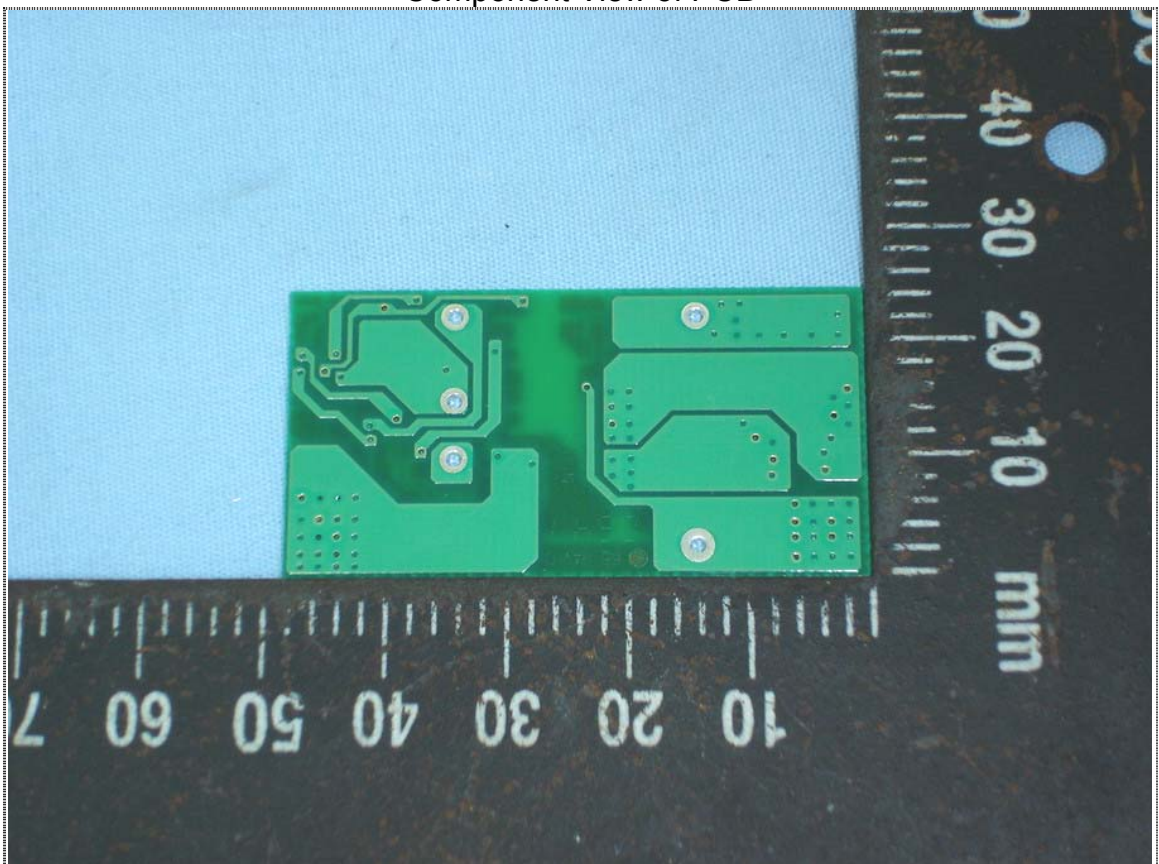

Solder View of PCB