



PLDC-P1JS-4P1JP-300

**1 YEAR
WARRANTY**

DC Splitter Lead

100% Functional Tested

RoHS Compliant



Cable Size	20AWG	Length	300mm
Connector A	2.1/5.5mm Socket	Connector B	4 x 2.1/5.5mm Plug
Wire Colour	Black	Barrel length	11±0.5
Insulation Resistance	10M Ω MIN / DV 300V / 10ms	Conducting Resistance	1 OHM Max
Max Rating	6A		

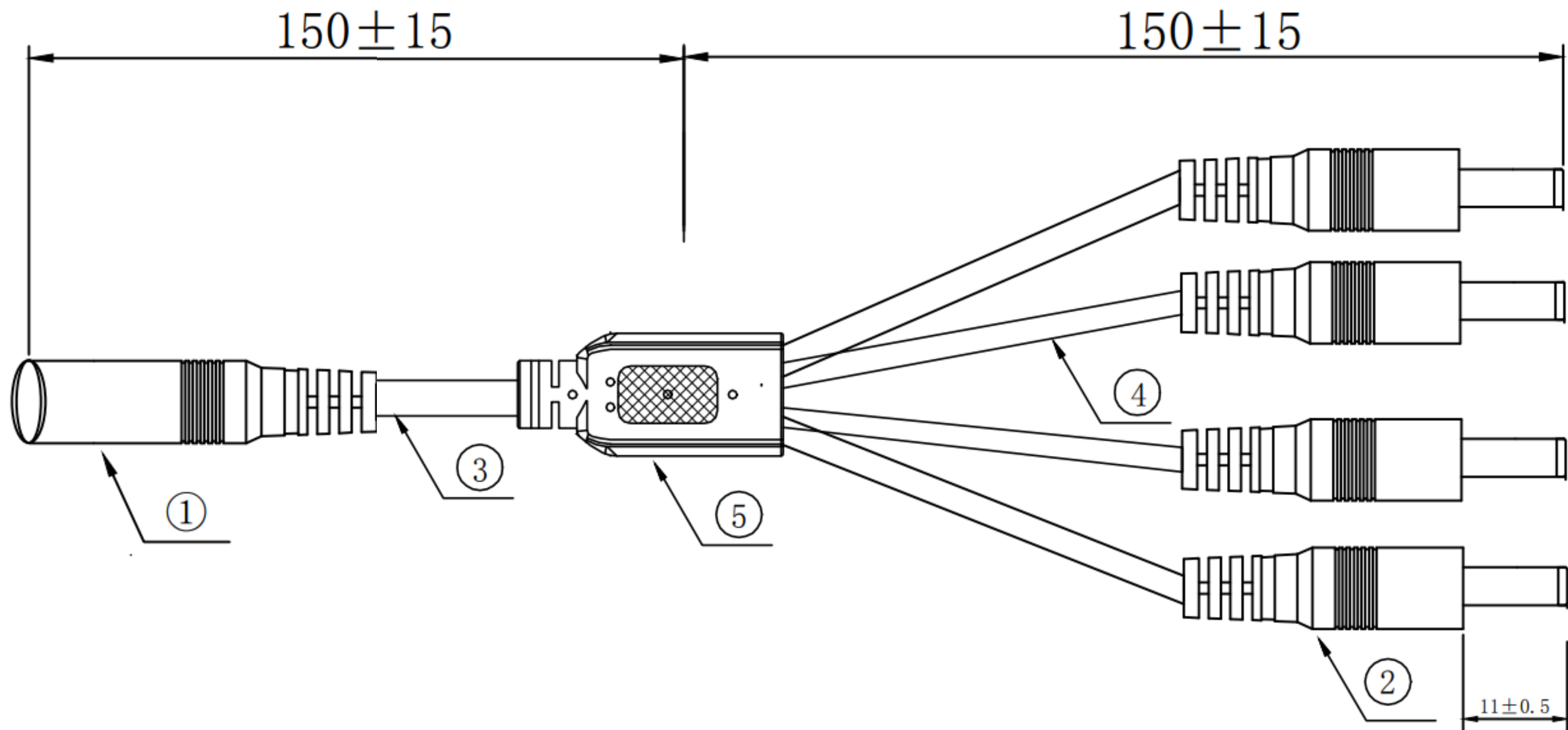

Connector A

Connector B

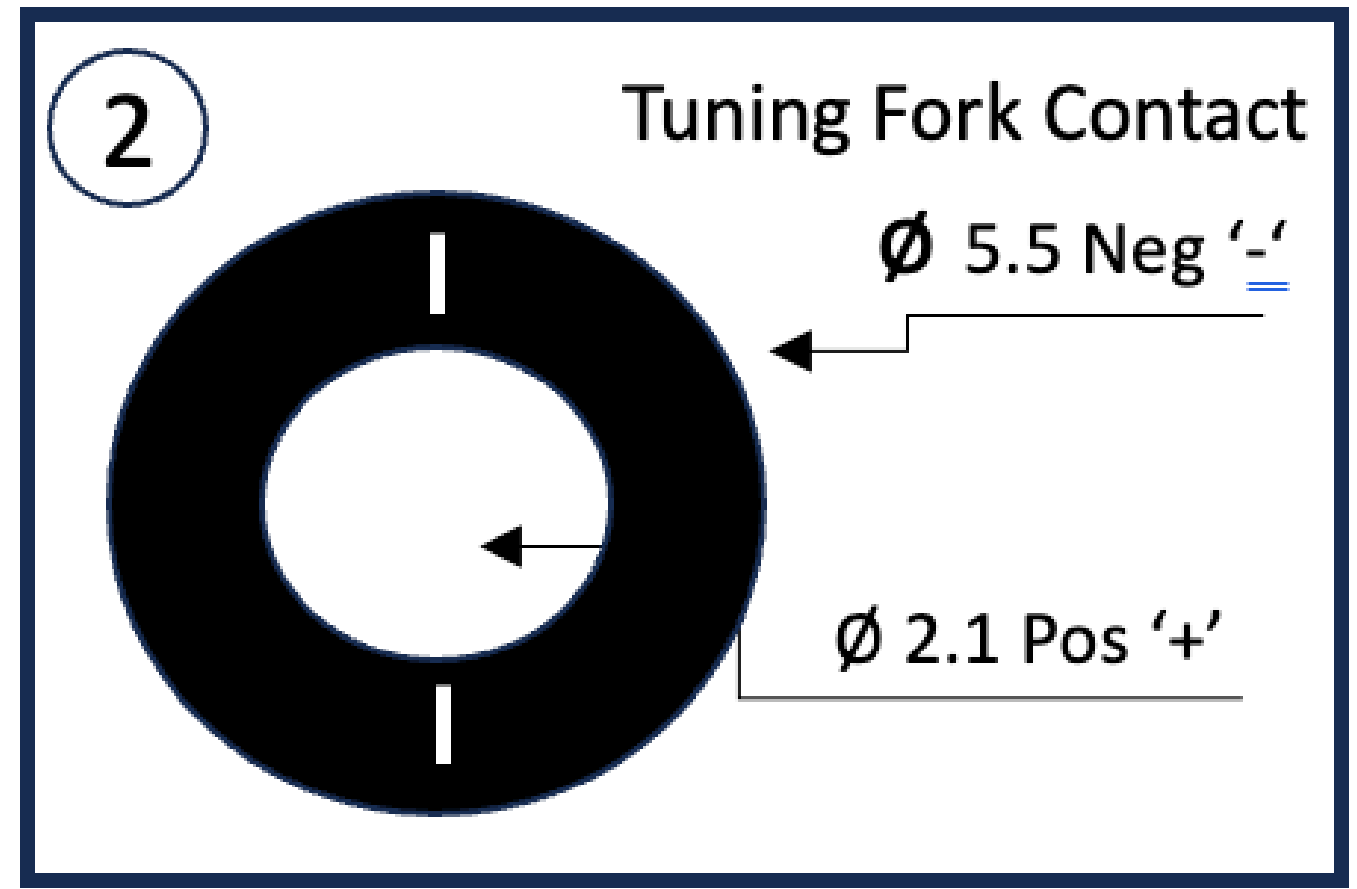
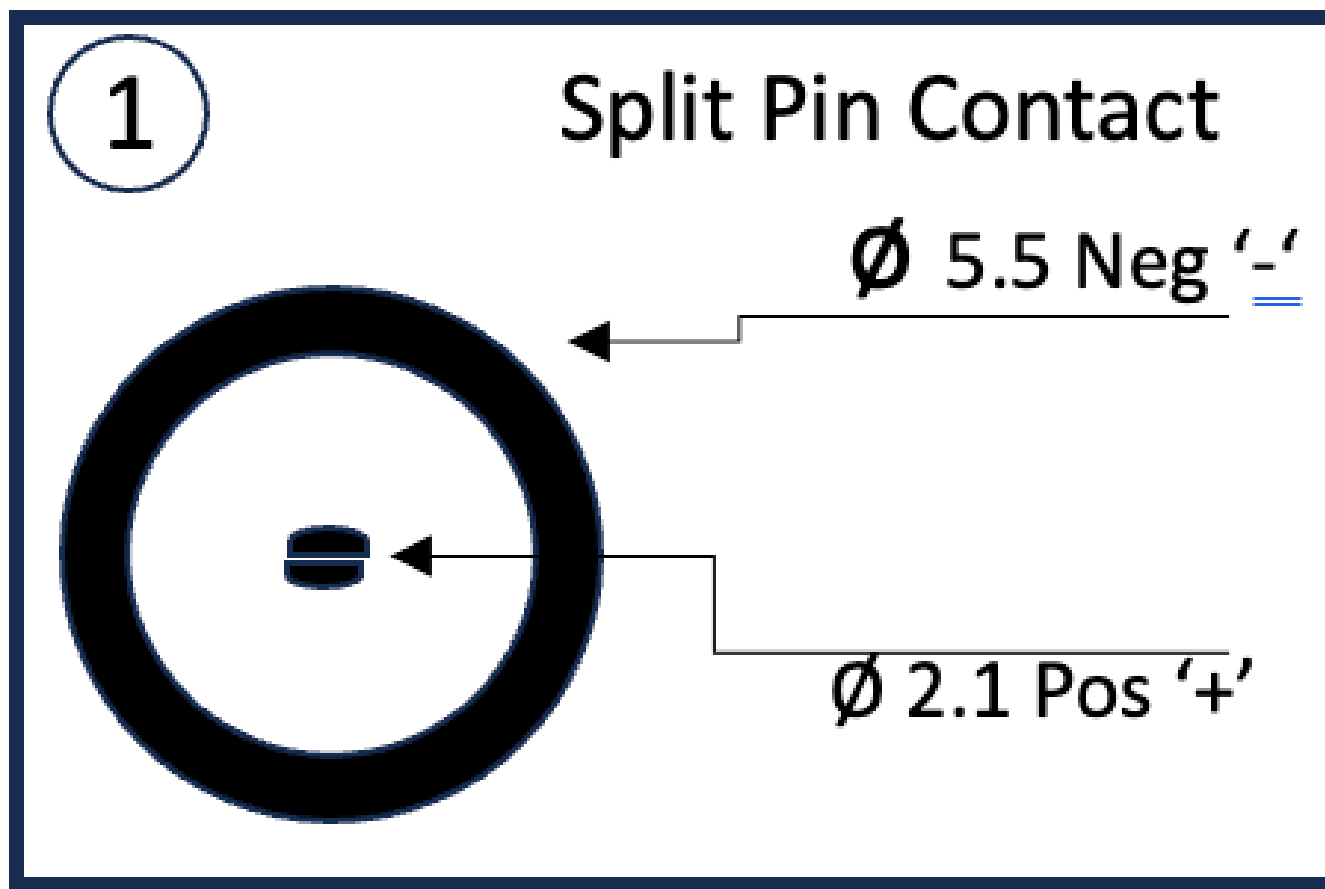

①	CONN	SPLIT PIN CONTACT FEMALE	1	PCS
②	CONN	TUNING FORK CONTACT MALE	4	PCS
③	CABLE	UL2464#20AWG*2C OD:4.0MM BLACK PVC L=150MM	150	MM
④	CABLE	UL2464#20AWG*2C OD:4.0MM BLACK PVC L=150MM	150	MM
⑤	CONN	BLACK SR	1	PCS