



■ Features

- **Global certificates**
- Universal AC input / Full range
- 3 pole AC inlet IEC320-C14, Class I power unit
- Built-in active PFC function
- No load power consumption < 0.15W
- **Energy efficiency Level VI**
- Comply with EISA 2007/DoE, NRCAN, Korea K-MEPS, AU/NZ MEPS, EU ErP and CoC Version 5
- Protections: Short circuit / Overload / Over voltage / Over temperature
- Fully enclosed plastic case
- -30~+70°C wide range working temperature
- LED indicator for power on
- **Various DC plug quick adapter accessory available**
(Plug kit sold separately, please refer to : https://www.meanwell.com/upload/pdf/DC_plug.pdf)
- 3 years warranty

■ Applications

- Consumer electronic devices
- Telecommunication devices
- Office facilities
- Industrial equipments

■ GTIN CODE

MW Search: <https://www.meanwell.com/serviceGTIN.aspx>

■ Description

GST120A is a highly reliable, 120W desktop style single-output green adaptor series. This product is a class I power unit (with FG), equipped with a standard IEC320-C14 AC inlet and adopting the input range from 85VAC to 264VAC. The entire series supplies different models with output voltages ranging between 12VDC and 48VDC that can satisfy the demands for various types of consumer electronic devices. With the efficiency up to 91% and the extremely low no-load power consumption below 0.15W, GST120A is compliant with USA EISA 2007/DoE, Canada NRCAN, Australia and New Zealand MEPS, Korea K-MEPS, EU ErP and Code of Conduct (CoC) Version 5. The supreme feature allows the adaptor to save the energy when it is either under the operating mode or the standby mode. The entire series utilizes the 94V-0 flame retardant plastic case. GST120A is certified for the international safety regulations.

■ Model Encoding

GST 120A 12 -R7B

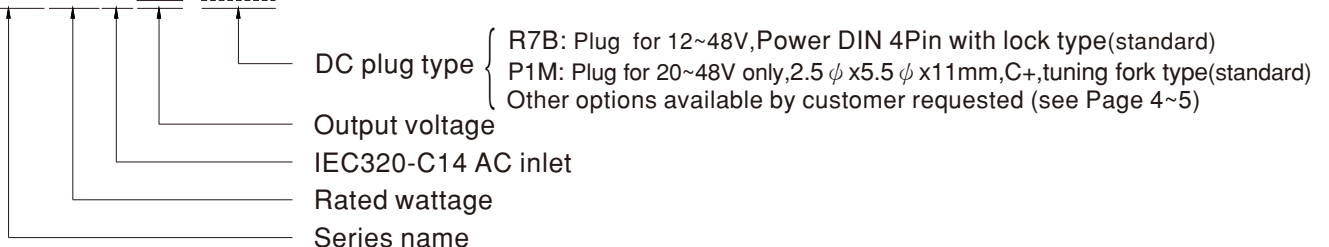

SPECIFICATION

ORDER NO.		GST120A12-R7B	GST120A15-R7B	GST120A20-□ □=R7B,P1M	GST120A24-□ □=R7B,P1M	GST120A48-□ □=R7B,P1M	
OUTPUT	SAFETY MODEL NO.	GST120A12	GST120A15	GST120A20	GST120A24	GST120A48	
	DC VOLTAGE	12V	15V	20V	24V	48V	
	RATED CURRENT	8.5A	7A	6A	5A	2.5A	
	CURRENT RANGE	0 ~ 8.5A	0 ~ 7A	0 ~ 6A	0 ~ 5A	0 ~ 2.5A	
	RATED POWER (max.)	102W	105W	120W	120W	120W	
	RIPPLE & NOISE (max.) Note.2	120mVp-p	120mVp-p	150mVp-p	180mVp-p	200mVp-p	
	VOLTAGE TOLERANCE Note.3	±5.0%	±5.0%	±5.0%	±3.0%	±2.5%	
	LINE REGULATION Note.4	±1.0%	±1.0%	±1.0%	±1.0%	±1.0%	
	LOAD REGULATION	±5.0%	±5.0%	±4.0%	±3.0%	±2.5%	
	SETUP, RISE TIME Note.5	2000ms, 30ms / 230VAC 2500ms, 30ms / 115VAC at full load					
HOLD UP TIME (Typ.)	20ms / 230VAC 20ms / 115VAC at full load						
INPUT	VOLTAGE RANGE Note.6	85 ~ 264VAC 120 ~ 370VDC					
	FREQUENCY RANGE	47 ~ 63Hz					
	POWER FACTOR (Typ.)	PF>0.93 / 230VAC PF>0.97 / 115VAC at full load					
	EFFICIENCY (Typ.)	R7B	88.5%	89%	90%	90.5%	91%
		P1M	-----	-----	89%	89.5%	90.5%
	AC CURRENT	1.4A / 115VAC 0.7A / 230VAC					
	INRUSH CURRENT (max.)	Cold start 35 / 115AC 70A / 230VAC					
LEAKAGE CURRENT(max.)	0.75mA / 240VAC						
PROTECTION	OVERLOAD	105 ~ 160% rated output power Protection type : Hiccup mode, recovers automatically after fault condition is removed					
	OVER VOLTAGE	105 ~ 135% rated output voltage Protection type : Shut down o/p voltage, re-power on to recover					
	OVER TEMPERATURE	Shut down o/p voltage, re-power on to recover					
ENVIRONMENT	WORKING TEMP.	-30 ~ +70°C (Refer to "Derating Curve")					
	WORKING HUMIDITY	20% ~ 90% RH non-condensing					
	STORAGE TEMP., HUMIDITY	-40 ~ +85°C, 10 ~ 95% RH non-condensing					
	TEMP. COEFFICIENT	±0.03% / °C (0~45°C)					
	VIBRATION	10 ~ 500Hz, 2G 10min./1cycle, period for 60min. each along X, Y, Z axes					
SAFETY & EMC (Note. 9)	SAFETY STANDARDS Note. 7	UL62368-1, CSA C22.2 No. 62368-1, TUV BS EN/EN62368-1, BSMI CNS14336, CCC GB4943.1, PSE J62368-1, AS/NZS 60950.1, BIS IS13252, KC K60950-1, EAC TP TC 004 approved					
	WITHSTAND VOLTAGE	I/P-O/P: 3KVAC					
	ISOLATION RESISTANCE	I/P-O/P:100M Ohms / 500VDC / 25°C / 70% RH					
	EMC EMISSION	Parameter	Standard			Test Level / Note	
		Conducted emission	BS EN/EN55032(CISPR32),FCC PART 15 / CISPR22 CAN ICES-3(B)/NMB-3(B),CNS13438,GB17625.1 EAC TP TC 020,MSIP KN32			Class B	
		Radiated emission	BS EN/EN55032(CISPR32),FCC PART 15 / CISPR22 CAN ICES-3(B)/NMB-3(B),CNS13438,GB17625.1 EAC TP TC 020,MSIP KN32			Class B	
		Harmonic current	BS EN/EN61000-3-2,GB9254			Class A	
		Voltage flicker	BS EN/EN61000-3-3			-----	
	EMC IMMUNITY	BS EN/EN55035					
		Parameter	Standard			Test Level /Note	
ESD		BS EN/EN61000-4-2			Level 4, 15KV air; Level 4, 8KV contact		
RF field susceptibility		BS EN/EN61000-4-3			Level 2, 3V/m		
EFT bursts		BS EN/EN61000-4-4			Level 2, 1KV		
Surge susceptibility		BS EN/EN61000-4-5			Level 3, 1KV/Line-Line , 2KV/Line-FG		
Conducted susceptibility		BS EN/EN61000-4-6			Level 2, 3V		
Magnetic field immunity		BS EN/EN61000-4-8			Level 2, 3A/m		
Voltage dips , interruption	BS EN/EN61000-4-11			>95% dip 0. 5 periods, 30% dip 25 periods, >95% interruptions 250 periods			
OTHERS	MTBF	2250.5K hrs min. Telcordia SR-332 (Bellcore) ; 368.5K hrs min. MIL-HDBK-217F (25°C)					
	DIMENSION	167*67*35mm (L*W*H)					
	PACKING	0.575Kg; 20pcs/12.5Kg/0.89CUFT					
CONNECTOR	PLUG	See page 4~5 ; Other type available by customer requested					
	CABLE	See page 4~5 ; Other type available by customer requested					
NOTE	<p>1. All parameters are specified at 230VAC input, rated load, 25°C 70% RH ambient.</p> <p>2. Ripple & noise are measured at 20MHz by using a 12" twisted pair terminated with a 0.1 μ F & 47 μ F capacitor.</p> <p>3. Tolerance: includes set up tolerance, line regulation, load regulation.</p> <p>4. Line regulation is measured from low line to high line at rated load.</p> <p>5. Length of set up time is measured at first cold start. Turning ON/OFF the power supply may lead to increase of the set up time.</p> <p>6. Derating may be needed under low input voltage. Please check the derating curve for more details.</p> <p>7. The ambient temperature derating of 3.5°C/1000m with fanless models and of 5°C/1000m with fan models for operating altitude higher than 2000m(6500ft).</p> <p>8. The power supply is considered as an independent unit, but the final equipment still need to re-confirm that the whole system complies with the EMC directives. For guidance on how to perform these EMC tests, please refer to "EMI testing of component power supplies." (as available on https://www.meanwell.com/Upload/PDF/EMI_statement_en.pdf)</p> <p>※ Product Liability Disclaimer : For detailed information, please refer to https://www.meanwell.com/serviceDisclaimer.aspx</p>						

Derating Curve

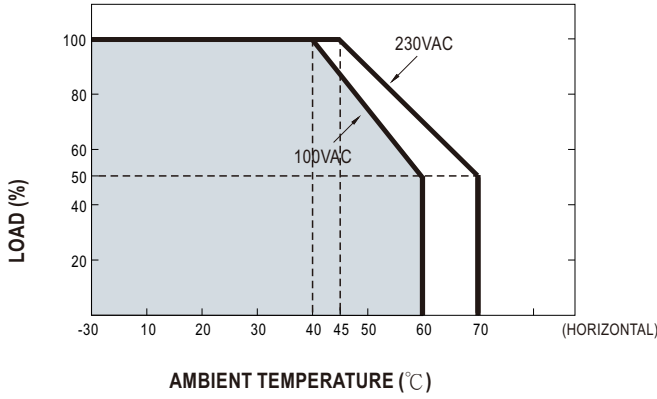

Static Characteristics

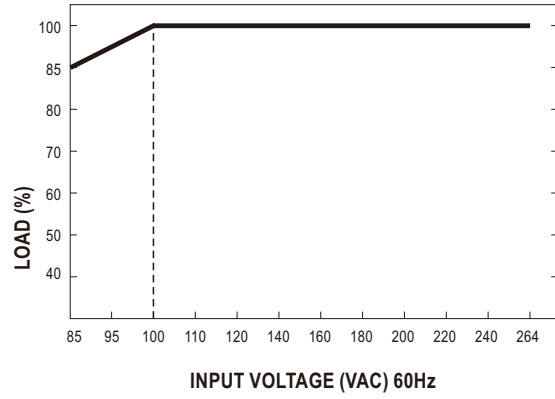

Mechanical Specification

(Unit: mm, tolerance ± 1mm)

Case No. GS120A

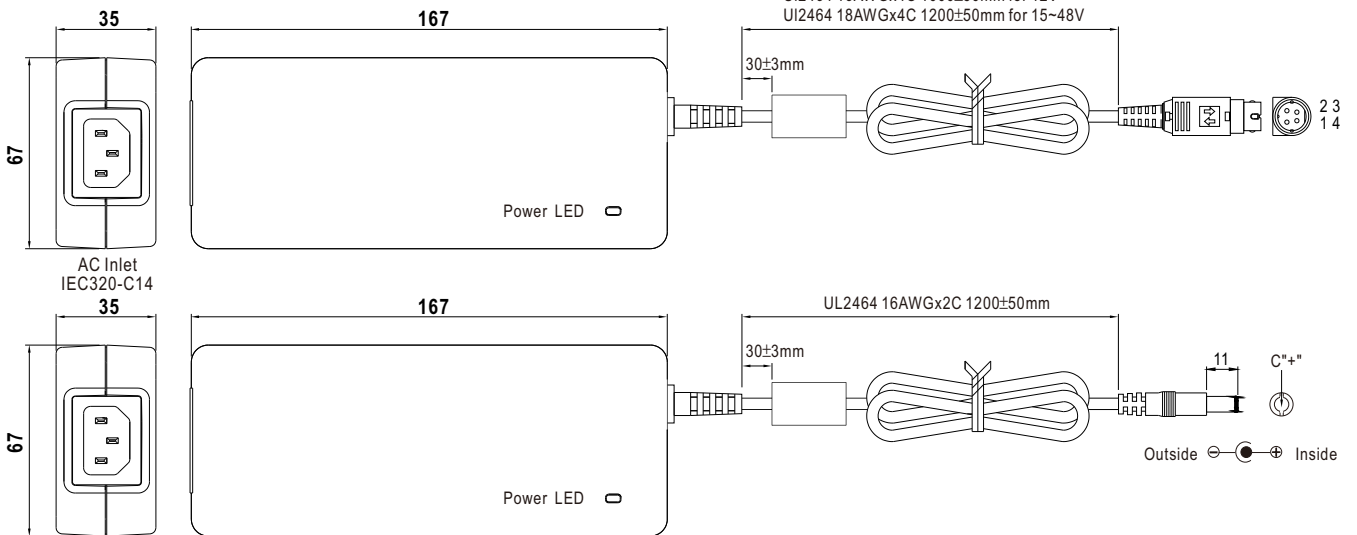

DC output plug

⊙ Standard plug

R7B		Pin Assignment										
<p>KYCON KPPX-4P equivalent</p>	<p>2 3 1 4</p> <p>AC FG -V connected to AC FG</p>	<table border="1"> <thead> <tr> <th>PIN NO.</th> <th>OUTPUT</th> </tr> </thead> <tbody> <tr><td>1</td><td>+Vo</td></tr> <tr><td>2</td><td>-Vo</td></tr> <tr><td>3</td><td>-Vo</td></tr> <tr><td>4</td><td>+Vo</td></tr> </tbody> </table>	PIN NO.	OUTPUT	1	+Vo	2	-Vo	3	-Vo	4	+Vo
		PIN NO.	OUTPUT									
		1	+Vo									
		2	-Vo									
3	-Vo											
4	+Vo											
P1M		Pin Assignment										
<p>5.5 2.5</p> <p>11±0.5mm</p>	<p>C*+*</p> <p>Outside ⊖ ⊕ Inside</p> <p>-V connected to AC FG</p>											

◎ DC plug changeable through:

- (1) Customization of the standard part with an optional DC plug according to the table (MOQ applicable)
- (2) Quick adapter accessory (sold separately without MOQ)

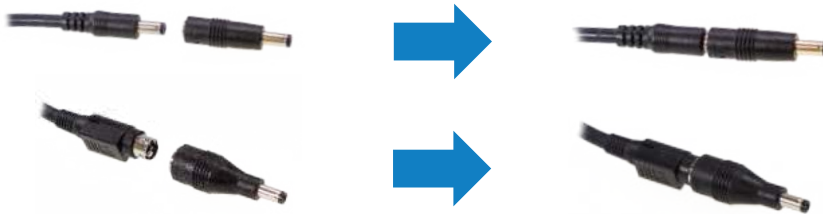

Please refer to below table and online selection guide : https://www.meanwell.com/upload/pdf/DC_plug.pdf

Example quick adapter accessory:

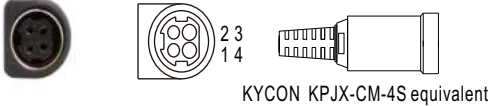

◎ Optional DC plug: (Available in customized cable or quick adapter)

Tuning Fork Style		Type No.	A	B	C	Quick Adapter Accessory	
			OD	ID	L		
	(Straight)	P1I	5.5	2.1	9.5	None	
		P1L	5.5	2.5	9.5		
		P1J	5.5	2.1	11.0		
		P1JR	5.5	2.1	11.0		
	(Right-angled)	P11R	5.5	2.1	9.5	Available for 15 ~ 48V (Current rating: 7.5A max.)	
		P1LR	5.5	2.5	9.5		
		P1MR	5.5	2.5	11.0		
		P1JR	5.5	2.1	11.0		
Barrel Style		Type No.	A	B	C	None	
			OD	ID	L		
	(Straight)	P2I	5.5	2.1	9.5		
		P2J	5.5	2.1	11.0		
		P2L	5.5	2.5	9.5		
		P2M	5.5	2.5	11.0		
	(Right-angled)	P2IR	5.5	2.1	9.5		
		P2JR	5.5	2.1	11.0		
		P2LR	5.5	2.5	9.5		
		P2MR	5.5	2.5	11.0		
Lock Style		Type No.	A	B	C		None
			OD	ID	L		
	P2S(S761K)	5.53	2.03	12.06			
	P2K(761K)	5.53	2.54	12.06			
	P2C(S760K)	5.53	2.03	9.52			
	P2D(760K)	5.53	2.54	9.52			
Center Pin Style		Type No.	A	B	C	D	None
			OD	ID	L	Center Pin	
	P4A	5.5	3.4	11.0	1.0		
	P4B	6.5	4.4	11.0	1.4		
	P4C	7.4	5.1	11.0	0.6		
Min. DIN 3 Pin with Lock (male)		Type No.	Pin Assignment				None
			PIN No.		Output		
	R6B	1		+Vo			
		2		-Vo			
		3		+Vo			

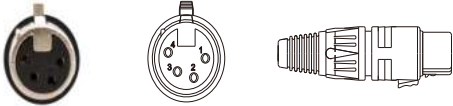
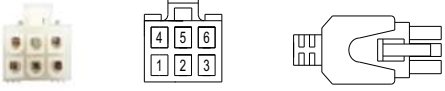
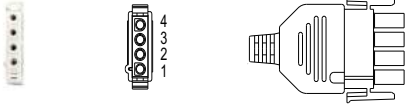
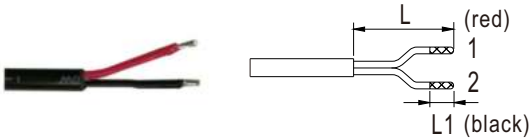
Min. DIN 4 Pin with Lock (female)	Type No.	Pin Assignment		Quick Adapter Accessory
		PIN No.	Output	
 <p>KYCON KPJX-CM-4S equivalent</p>	R7BF	1	+Vo	None
		2	-Vo	
		3	-Vo	
		4	+Vo	
DIN 5 Pin (male)	Type No.	Pin Assignment		
		PIN No.	Output	
	R1B	1	-Vo	None
		2	-Vo	
		3	+Vo	
		4	-Vo	
		5	+Vo	
NEUTRIK XLR NC4FX equivalent	Type No.	Pin Assignment		
		PIN No.	Output	
	MIC4	1	+Vo	None
		2	+Vo	
		3	-Vo	
		4	-Vo	
MOLEX 39-01-2060 (4.2mm) equivalent	Type No.	Pin Assignment		
		PIN No.	Output	
	C6P	1	+Vo	None
		2	+Vo	
		3	+Vo	
		4	-Vo	
		5	-Vo	
		6	-Vo	
AMP 1-480702-0 (6.35mm) equivalent	Type No.	Pin Assignment		
		PIN No.	Output	
	C4P	1	+Vo	None
		2	+Vo	
		3	-Vo	
		4	-Vo	
Stripped and tinned leads	Type No.	Pin Assignment		
		PIN No.	Output	
 <p>Length of Land L1 by request (MW's standard length, L: <u>25</u> mm, L1: <u>5</u> mm) (NOTE: The wire color is for reference only, please refer to the actual product)</p>	by customer	1	+Vo	None
		2	-Vo	

■ Installation Manual

Please refer to : <http://www.meanwell.com/manual.html>